

User focused functionality

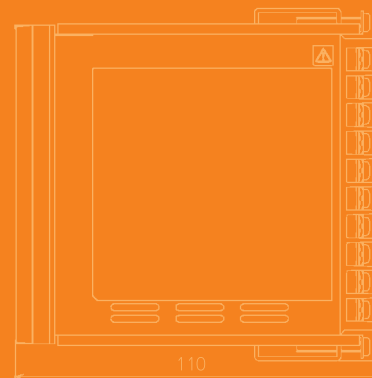

Max 9-patterns, 9-steps each, programmable
Simple time and temperature setting

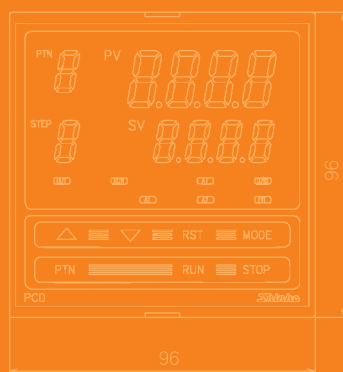

Multi-point program control,
using the set value digital transmission



(HQ only)

Features

Max. 9 patterns

9 steps per pattern are available for program control.

Easy programming

To set the program, just input the step temperature and step time for each step.

Multi-input

18 types of input are provided from thermocouple (10 types), RTD (2 types), DC current (2 types) and DC voltage (4 types).

Drip-proof structure

IP66 for the front face

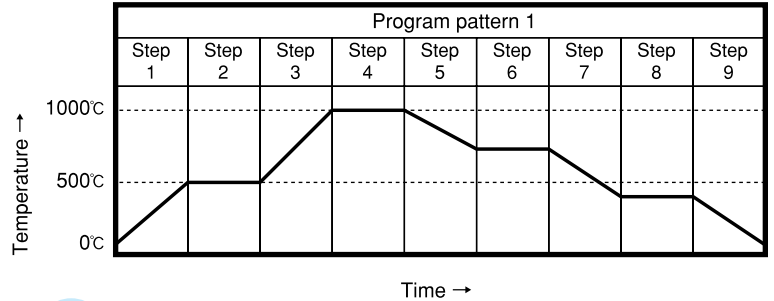

Enhanced communication functions

The communication type can be selected from 5 types (Shinko protocol, Set value digital transmission, Set value digital reception, Modbus ASCII mode and Modbus RTU mode). If Set value digital transmission is selected, SV of PCD-33A can be transmitted digitally to the JC□-33A series, etc. to which communication function (C5 option) is added. If Set value digital reception function is selected, PCD-33A can also receive the set value digitally from devices such as the JC□-33A series, etc. to which communication function (C5 option) is added.

Model

PCD-33A-□/M □, □□□		Series name: PCD-33A(W96xH96xD100mm)
Control output (OUT)	R	Relay contact: 1a1b
	S	Non-contact voltage (for SSR drive): 12 ⁺ 5V DC
Input	A	DC current: 4 to 20mA DC
	M	Multi-input (K, J, R, S, B, E, T, N, PL-II, C (W/Re5-26), Pt100, JPt100, 4 to 20mA, 0 to 20mA, 0 to 1V, 0 to 5V, 1 to 5V, 0 to 10V)
Supply voltage	1	24V AC/DC 50/60Hz (*1)
Option	C5	Serial communication (EIA RS-485)(*2)
	SVTC	Set value digital transmission(*2)
	P24	Insulated power output (*3)
	BK	Color, black
	TC	Terminal cover

Designate your specifications in the □, □□□ columns.

When adding an option, enter it punctuated by a comma.

(*1) For the power supply, 100 to 240V AC is standard. However, when ordering 24V AC/DC, enter "1" after the input.

(*2) When [C5 option] or [SVTC option] is added, the external operation function is not usable. [C5 option] and [SVTC option] cannot be added together.

(*3) When [P24 option] is added, Alarm 2 (A2) is not usable.

Example of order code

PCD-33A-A/M, C5

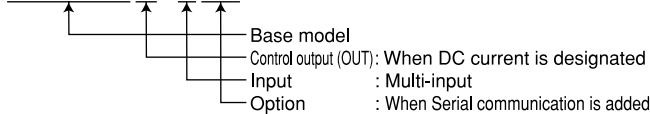

Rated scale

Input type	Input range		
Thermocouple	K	-200 to 1370 °C	-320 to 2500 °F
	J	-199.9 to 400.0 °C	-199.9 to 750.0 °F
	R	0 to 1760 °C	0 to 3200 °F
	S	0 to 1760 °C	0 to 3200 °F
	B	0 to 1820 °C	0 to 3300 °F
	E	-200 to 800 °C	-320 to 1500 °F
	T	-199.9 to 400.0 °C	-199.9 to 750.0 °F
	N	-200 to 1300 °C	-320 to 2300 °F
	PL-II	0 to 1390 °C	0 to 2500 °F
	C(W/Re5-26)	0 to 2315 °C	0 to 4200 °F
RTD	Pt100	-199.9 to 850.0 °C	-199.9 to 999.9 °F
	JPt100	-200 to 850 °C	-300 to 1500 °F
DC current	4 to 20mA	-1999 to 9999 (*)	
	0 to 20mA	-1999 to 9999 (*)	
DC voltage	0 to 1V	-1999 to 9999 (*)	
	0 to 5V	-1999 to 9999 (*)	
	1 to 5V	-1999 to 9999 (*)	
	0 to 10V	-1999 to 9999 (*)	

(*1) For DC current and DC voltage input, scaling and decimal point place change are possible.

-1999 to 9999, -199.9 to 999.9, -19.99 to 99.99, -1.999 to 9.999

For DC current input, 50 Ω shunt resistor (sold separately) has to be externally installed.

Standard specifications

Display	PV----- Red 4-digit character size: 18.0 x 8.0mm (H x W) SV----- Green 4-digit character size: 12.6 x 6.0mm (H x W)	PTN---- Green 1-digit character size: 12.6 x 6.0mm (H x W) STEP--- Green 1-digit character size: 12.6 x 6.0mm (H x W)
Input	Thermocouple-----K, J, R, S, B, E, T, N, PL-II, C (W/Re5-26) External resistance: 100 Ω or less (For B input: 40 Ω or less) RTD-----Pt100, JPt100 3-wire system (Allowable input lead wire resistance, 10 Ω or less per wire) DC current-----4 to 20mA, 0 to 20mA DC Input impedance: 50 Ω [When connecting 50 Ω shunt resistor (sold separately) between input terminals.] Allowable input current: 50mA DC or less [when using 50 Ω shunt resistor (sold separately)] DC voltage-----0 to 1V DC Input impedance: 1M Ω or more Allowable input voltage: 5V DC or less Allowable signal source resistance: 2k Ω or less 0 to 5V, 1 to 5V, 0 to 10V DC Input impedance: 100k Ω or more Allowable input voltage: 15V DC or less Allowable signal source resistance: 100 Ω or less	Resolution-----Thermocouple, RTD--- without decimal point: 1 °C (1 °F), with decimal point: 0.1 °C (0.1 °F), DC current, DC voltage--- 1
Accuracy (setting, indication)	Thermocouple----- Within ±0.2% of input span ±1digit, or within ±2 °C (4 °F), whichever is greater However, for R or S input, 0 to 200 °C (0 to 400 °F): Within ±6 °C (12 °F) B input, 0 to 300 °C (0 to 600 °F): Accuracy is not guaranteed. K, J, E, N, T inputs, less than 0 °C (32 °F): Within ±0.4% of input span ±1digit RTD----- Within ±0.1% of input span ±1digit, or within ±1 °C (2 °F), whichever is greater DC current, DC voltage--- Within ±0.2% of input span ±1digit	
Time indication accuracy	Within ±0.5% of setting time	
Input sampling period	0.25 seconds	
Control output (OUT)	Relay contact----- 1a1b 3A 250V AC (resistive load), 1A 250V AC (inductive load cos φ = 0.4), Electric life: 100,000 cycles Non-contact voltage-- 12 ⁺ 5V DC Max. 40mA DC (short circuit protected) DC current-----4 to 20mA DC Load resistance: Max. 550 Ω	
Control action	Control action type • PID action (with auto-tuning) • PI action (when derivative time is set to 0) • PD action (when integral time is set to 0) • P action (when both derivative and integral times are set to 0) • ON/OFF action (when proportional band is set to 0) Control parameter • Proportional band (P)----- Thermocouple, RTD (without decimal point): 0 to 1000 °C (0 to 2000 °F) Thermocouple, RTD (with decimal point): 0.0 to 999.9 °C (° F) For DC input, 0.0 to 100.0% • Integral time(I)----- 0 to 1000 seconds (Off when set to 0) • Derivative time(D)----- 0 to 300 seconds (Off when set to 0) • Proportional cycle----- 1 to 120 seconds (Not available for DC current output) • ARW----- 0 to 100% • Hysteresis----- 0.1 to 100.0 °C (° F) For DC input, 1 to 1000 (The placement of the decimal point follows the selection.) • Output high limit, low limit--- 0 to 100% (For DC current output, -5 to 105%)	

Alarm 1 (A1) Alarm 2 (A2)	A1 and A2 alarm types and status Energized/Deenergized can be selected by keypad operation. All alarm actions (except for Process high alarm and low alarm) are \pm deviation setting from SV. If Energized is selected and when input is out of the range, the alarm output turns ON (If Deenergized is selected, the alarm output turns OFF).	
	Alarm type	Setting range
	No alarm action	
	High limit alarm	—Input span to input span (Off when set to 0 or 0.0) (Deviation setting)
	Low limit alarm	—Input span to input span (Off when set to 0 or 0.0) (Deviation setting)
	High/Low limits alarm	0 to input span (Off when set to 0 or 0.0) (Deviation setting)
	High/Low limit range alarm	0 to input span (Off when set to 0 or 0.0) (Deviation setting)
	Process high alarm	Input range minimum value to input range maximum value
	Process low alarm	Input range minimum value to input range maximum value
	High limit alarm with standby	—Input span to input span (Off when set to 0 or 0.0) (Deviation setting)
Low limit alarm with standby	—Input span to input span (Off when set to 0 or 0.0) (Deviation setting)	
High/Low limits alarm with standby	0 to input span (Off when set to 0 or 0.0) (Deviation setting)	
When input has a decimal point, the negative minimum value is -199.9 and the positive maximum value is 999.9 . For DC input, input span is the same as scaling span, and input range minimum (or maximum) value is the same as the scaling low (or high) limit value.		
Setting accuracy-- The same as the indication accuracy		
Action----- ON/OFF action		
Hysteresis----- 0.1 to 100.0°C(°F) For DC input, 1 to 1000 (The placement of the decimal point follows the selection.)		
Output----- Relay contact 1a 3A 250V AC (resistive load), 1A 250V AC (inductive load $\cos \phi = 0.4$), Electric life: 100,000 cycles		
Event output (EVT)	One output can be selected from 3 outputs (Time signal output, Pattern end output and RUN output) by front keypad operation. Time signal output : If time signal OFF time and time signal ON time are set, time signal is outputted within the total time taken for 1 pattern during program control. Pattern end output : Outputs signal for the set time after the program ends. RUN output : Outputs during program control. Output : Relay contact, 1a 3A 250V AC (resistive load), 1A 250V AC (inductive load $\cos \phi = 0.4$), Electric life: 100,000 cycles	
Supply voltage	100 to 240 V AC 50/60Hz(Allowable voltage fluctuation range: 85 to 264V AC), 24V AC/DC 50/60Hz(Allowable voltage fluctuation range: 20 to 28V AC/DC)	
Power consumption	Approx. 8VA	
Insulation resistance	If control output (OUT) is non-contact voltage output or DC current output, insulation tests must not be carried out between control output (OUT) terminal and external operation terminal, and between control output (OUT) terminal and communication terminal because they are not insulated from one another. Other combinations except the above: 10M Ω or more, at 500V DC	
Dielectric strength	Between input terminal and ground terminal, between input terminal and power terminal----- 1.5kV AC for 1 minute Between power terminal and ground terminal----- 1.5kV AC for 1 minute Between output terminal and ground terminal, between output terminal and power terminal----- 1.5kV AC for 1 minute	
Environment	Ambient temperature : 0 to 50°C (32 to 122°F), Ambient humidity : 35 to 85%RH (non-condensing)	
Safety standard	UL: Power input rating 100-240V AC, 24V AC/DC File No. E159038	
Material, Color	Material: Flame-resistant resin, Color: Light gray	
Mounting method	Flush, Mounting brackets: Screw type Mountable panel thickness: 1 to 8mm	
Dust-proof/Drip-proof	IP66 for front face	
Setting method	Sheet key input	
Weight	Approx. 370g	
Attached function	Power failure countermeasures, Self diagnosis, Automatic cold junction temperature compensation (only for thermocouple), Sensor burnout alarm, Input burnout	

■Program performance

Number of patterns	9 patterns
Number of steps	9 steps/pattern
External operation function	Program control can start/stop by opening/closing the external contact or open collector. Program control starts when the contact is switching from Open to Closed, and stops when the contact is switching from Closed to Open.
WAIT function	During program run, the program does not proceed to the next step until deviation between PV and SV when step ends enters the WAIT set value. Setting range----- Thermocouple, RTD (without decimal point): $\pm(0$ to $100)^{\circ}\text{C}(^{\circ}\text{F})$ Thermocouple, RTD (with decimal point): $\pm(0.0$ to $100.0)^{\circ}\text{C}(^{\circ}\text{F})$ DC input: 0 to 1000 (The placement of the decimal point follows the selection.)
HOLD function	Program control RUN time is held temporarily.
ADVANCE function	The step during program control RUN can be stopped and advanced to the next step.
Other functions	Step time unit selection (Hour:Minute or Minute:Second), Program control start type selection (PV start or SV start), Step temperature setting when starting program control
Program time range	0 to 99 hours 59 minutes/step, or 0 to 99 minutes 59 seconds/step
Time setting accuracy	Within $\pm 0.5\%$ of setting time
Setting resolution	Temperature: 1°C(1°F) or 0.1°C(0.1°F), Time: 1 minute or 1 second
Status after power is restored	Program starts to perform from the status before power failure. (Time error after power is restored: Max. 1 minute)

■Options

Serial communication [C5]	Each setting status change, set value reading and setting, etc. of PCD-33A can be operated from the external computer. (If C5 option is added, external operation function is not usable. The SVTC option and external operation function cannot be applied together.)	
	Communication interface-----	EIA RS-485
	Communication method-----	Half-duplex communication
	Synchronization method-----	Start-stop synchronization
	Communication protocol -----	Shinko protocol/Set value digital transmission/Set value digital reception/Modbus ASCII mode/Modbus RTU mode Selectable by keypad (Default: Shinko protocol)
	Communication speed -----	2400/4800/9600/19200bps Selectable by keypad (Default: 9600bps)
	Parity -----	Even/Odd/No parity Selectable by keypad (Default: Even)
	Stop bit -----	1 or 2 Selectable by keypad (Default: 1)
	Communication error detection -----	Dual-detection by parity and checksum
	Number of connectable units---	Max. 31 units per host computer
Insulated power output [P24]	Outputs 24V DC. This is used for the power of 2-wire transmitter such as a pressure transducer. (If the P24 option is applied, Alarm 2 (A2) is not usable.) Output voltage----- 24V \pm 3V DC (load current 30mA) Ripple voltage----- Within 200mV DC (load current 30mA) Max. load current----- 30mA DC	

Set value digital transmission [SVTC]	<p>Set value digital transmission (Master) If Set value digital transmission (Master) is selected during Communication protocol selection, SV of PCD-33A can be transmitted digitally to the controllers such as JC□-33A series (Slave) with communication function (C5 option).</p> <p>Set value digital reception (Slave) If Set value digital reception (Slave) is selected during Communication protocol selection, the SV can be received from the PC-900 series/PCD-33A (Master) with Set value digital transmission (SVTC option). (If the SVTC option is added, external operation function is not usable, and C5 option and external operation function cannot be applied together.)</p>
Terminal cover [TC]	Electric shock protection terminal cover Be sure to use this terminal cover by adding this option if operator may touch the back of the controller while running the controller.
Color Black [BK]	Case: Black, Panel: Dark gray

External dimensions (Scale: mm)

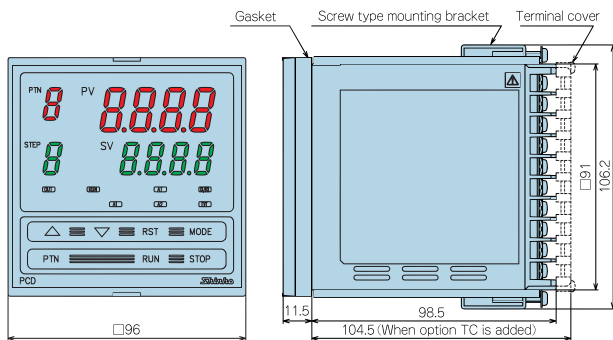

Panel cutout (Scale: mm)

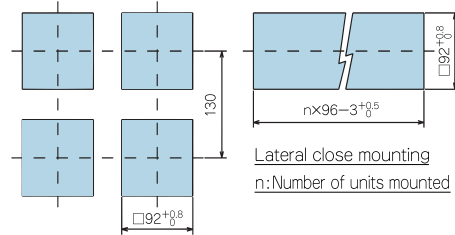

Caution: If lateral close mounting is used, IP66 specification (Dust-proof/Drip-proof) may be compromised, and all warranties will be invalidated.

- Panel thickness is 1 to 8mm.
- As the case is made of resin, do not use excessive force while screwing in the mounting bracket. The case or screw type mounting bracket could be damaged. The torque should be 0.12N·m.

Terminal arrangement

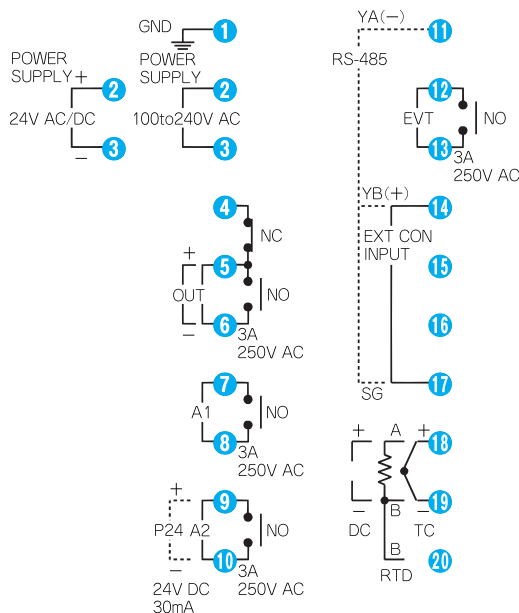

- POWER SUPPLY : 100 to 240V AC or 24V AC/DC
- OUT : Control output
- A1 : Alarm output 1
- A2 : Alarm output 2
- P24 : Insulated power output (P24 option)
- RS-485 : Serial communication (C5 option)
- EVT : Event output
- EXT CON INPUT : External operation input
- TC : Thermocouple input
- RTD : RTD input
- DC : DC current, DC voltage inputs

- The terminal block is designed to be wired from the left side.
- Dotted lines show options.
- When [P24 option] is added, Alarm 2 (A2) is not usable.
- When [C5 option] is added, external operation function is not usable.

Solderless terminal

Use a solderless terminal with an insulation sleeve in which the M3 screw fits as shown below. The torque should be 0.63N·m.

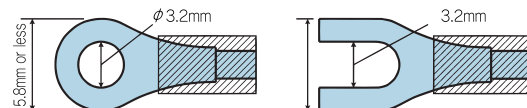

SAFETY PRECAUTIONS

- To ensure safe and correct use, thoroughly read and understand the manual before using this instrument.
- This instrument is intended to be used for industrial machinery, machine tools and measuring equipment. Verify correct usage after consulting purpose of use with our agency or main office. (Never use this instrument for medical purposes with which human lives are involved.)
- External protection devices such as protection equipment against excessive temperature rise, etc. must be installed, as malfunction of this product could result in serious damage to the system or injury to personnel. Also proper periodic maintenance is required.
- This instrument must be used under the conditions and environment described in the manual. Shinko Technos Co., Ltd. does not accept liability for any injury, loss of life or damage occurring due to the instrument being used under conditions not otherwise stated in the manual.

Caution with respect to Export Trade Control Ordinance

To avoid this instrument from being used as a component in, or as being utilized in the manufacture of weapons of mass destruction (i.e. military applications, military equipment, etc.), please investigate the end users and the final use of this instrument. In the case of resale, ensure that this instrument is not illegally exported.

This catalog is as of January 2009 and its contents are subject to change without notice. If you have any inquiries, please consult us or our agency.

SHINKO TECHNOS CO., LTD. OVERSEAS DIVISION

Reg. Office: 2-5-1, Senbahigashi, Minoo, Osaka, 562-0035, Japan
 Tel : 81 - 72 - 727 - 6100
 Fax : 81 - 72 - 727 - 7006
 URL : <http://www.shinko-technos.co.jp>
 E-mail : overseas@shinko-technos.co.jp