

Shinko**SHINKO TECHNOS CO., LTD.**

Head office: 2-5-1, Senbahigashi, Minoo, Osaka, 562-0035, Japan

TEL: +81-72-727-6100

FAX: +81-72-727-7006

URL: <http://www.shinko-technos.co.jp/e/>E-mail: overseas@shinko-technos.co.jp

For detailed usage, refer to the Instruction Manual for the BCS2, BCR2, and BCD2. Please download the full Instruction Manual from Shinko website.
<http://shinko-technos.co.jp/e/> → Support & Downloads → Downloads → Manuals

Thank you for purchasing our BCS2, BCR2, BCD2, Digital Indicating Controller. This manual contains instructions for the mounting, functions, operations and notes when operating the BCS2, BCR2, and BCD2. To ensure safe and correct use, thoroughly read and understand this manual before using this instrument. To prevent accidents arising from the misuse of this instrument, please ensure the operator receives this manual.

Safety Precautions (Be sure to read these precautions before using our products.)

The safety precautions are classified into 2 categories: "Warning" and "Caution".

⚠ Warning: Procedures which may lead to dangerous conditions and cause death or serious injury, if not carried out properly.

⚠ Caution: Procedures which may lead to dangerous conditions and cause superficial to medium injury or physical damage or may degrade or damage the product, if not carried out properly.

⚠ Warning

- To prevent an electric shock or fire, only Shinko or other qualified service personnel may handle the inner assembly.
- To prevent an electric shock, fire or damage to the instrument, parts replacement may only be undertaken by Shinko or other qualified service personnel.

⚠ SAFETY PRECAUTIONS

- To ensure safe and correct use, thoroughly read and understand this manual before using this instrument.
- This instrument is intended to be used for industrial machinery, machine tools and measuring equipment. Verify correct usage after purpose-of-use consultation with our agency or main office. (Never use this instrument for medical purposes with which human lives are involved.)
- External protection devices such as protective equipment against excessive temperature rise, etc. must be installed, as malfunction of this product could result in serious damage to the system or injury to personnel. Proper periodic maintenance is also required.
- This instrument must be used under the conditions and environment described in this manual. Shinko Technos Co., Ltd. does not accept liability for any injury, loss of life or damage occurring due to the instrument being used under conditions not otherwise stated in this manual.

⚠ Caution for Mounting

This instrument is intended to be used under the following environmental conditions (IEC61010-1): Overvoltage category II, Pollution degree 2
 Ensure the mounting location corresponds to the following conditions:

- A minimum of dust, and an absence of corrosive gases
- No flammable, explosive gases
- No mechanical vibrations or shocks
- No exposure to direct sunlight, an ambient temperature of -10 to 55°C (14 to 131°F) (No icing)
- An ambient non-condensing humidity of 35 to 85%RH (Non-condensing)
- No large capacity electromagnetic switches or cables through which large current is flowing
- No water, oil or chemicals or where the vapors of these substances can come into direct contact with the unit
- Take note that the ambient temperature of this unit – not the ambient temperature of the control panel – must not exceed 55°C (131°F) if mounted through the face of a control panel, otherwise the life of electronic components (especially electrolytic capacitors) may be shortened.

⚠ Caution with respect to Export Trade Control Ordinance

To avoid this instrument from being used as a component in, or as being utilized in the manufacture of weapons of mass destruction (i.e. military applications, military equipment, etc.), please investigate the end users and the final use of this instrument. In the case of resale, ensure that this instrument is not illegally exported.

Specifications

Power supply voltage	100 to 240 V AC 50/60Hz, Allowable fluctuation: 85 to 264 V AC 24 V AC/DC 50/60Hz, Allowable fluctuation: 20 to 28 V AC/DC
Base accuracy (At ambient temperature 23°C, for a single unit mounting)	Thermocouple: Within $\pm 0.2\%$ of each input span ± 1 digit. However, R, S inputs, 0 to 200°C (32 to 392°F): Within $\pm 6^\circ\text{C}$ (12°F) B input, 0 to 300°C (32 to 572°F): Accuracy is not guaranteed. K, J, E, T, N inputs, Less than 0°C (32°F): Within $\pm 0.4\%$ of input span ± 1 digit RTD: Within $\pm 0.1\%$ of each input span ± 1 digit Direct current, voltage inputs: Within $\pm 0.2\%$ of each input span ± 1 digit
Input sampling period	125 ms
Power consumption	100 to 240 V AC: Approx. 8 VA max. (11VA max. if all options added) 24 V AC: Approx. 5 VA max. (8 VA max. if all options are added) 24 V DC: Approx. 5 W max. (8 W max. if all options are added)
Ambient temperature/Humidity	-10 to 55°C, 35 to 85%RH (No icing, Non-condensing)
Weight	BCS2: Approx. 110g, BCR2: Approx. 160g, BCD2: Approx. 220g
Accessories	Mounting frame: 1 piece (BCS2) Screw type mounting bracket: 1 piece (BCR2, BCD2) Instruction manual excerpt: 1 copy

Control output (OUT1)	Relay contact 1a, Control capacity: 3 A 250 V AC (resistive load) 1 A 250 V AC (inductive load $\cos\phi=0.4$) Electric life: 100,000 cycles, Minimum applicable load: 10 mA 5 V DC Non-contact voltage (for SSR drive): 12 V DC $\pm 15\%$ Max 40 mA (short circuit protected) Direct current: 4 to 20 mA DC (Resolution: 12000) Load resistance: Max. 550 Ω
EVT output	Relay contact 1a, Control capacity: 3 A 250 V AC (resistive load) 1 A 250 V AC (inductive load $\cos\phi=0.4$) Electric life: 100,000 cycles, Minimum applicable load: 10 mA 5 V DC
Control output (OUT2) (DS, DA, EV2 options)	Relay contact 1a, Control capacity: 3 A 250 V AC (resistive load) 1 A 250 V AC (inductive load $\cos\phi=0.4$) Electric life: 100,000 cycles (If EV2 option is ordered, and 019 is selected from Event Output EV2 allocation.) Non-contact voltage (for SSR drive): 12 V DC $\pm 15\%$ Max 40 mA (short circuit protected) Direct current: 4 to 20 mA DC (Resolution: 12000) Load resistance: Max 550 Ω

Dimensions (Scale: mm)

(*) When terminal cover is used.

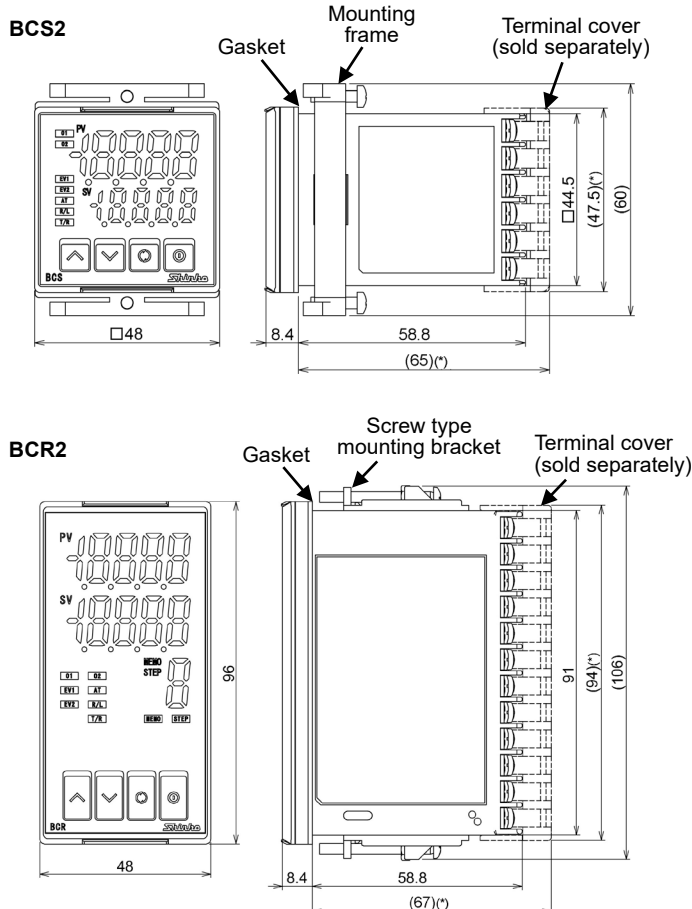

Panel Cutout (Scale: mm)

⚠ Caution

If horizontal close mounting is used for the unit, IP66 specification (Drip-proof/Dust-proof) may be compromised, and all warranties will be invalidated.

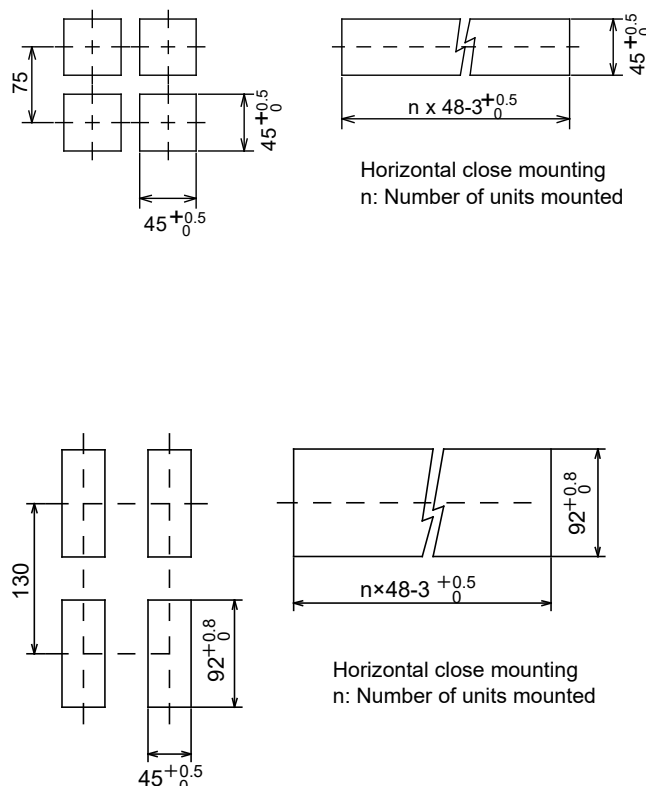

BCD2

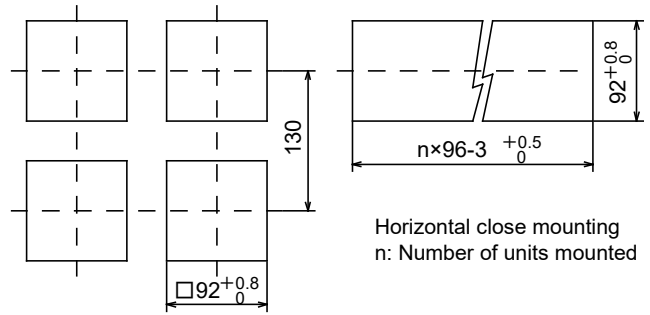
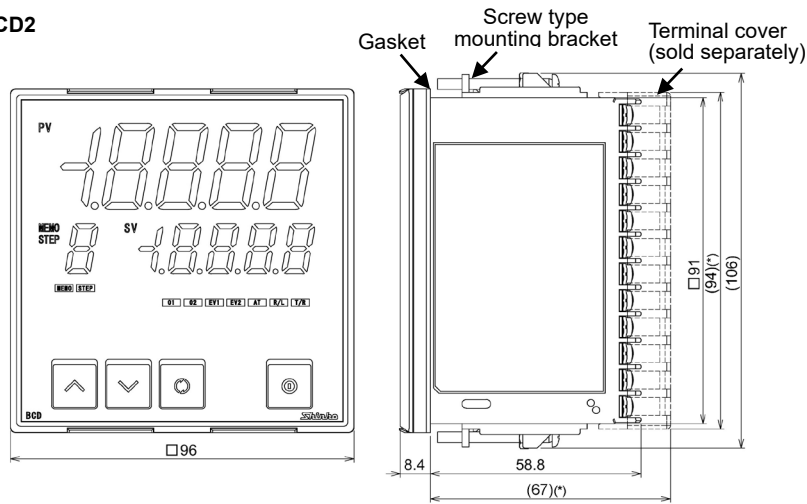

Names and Functions of Controller

BCS2

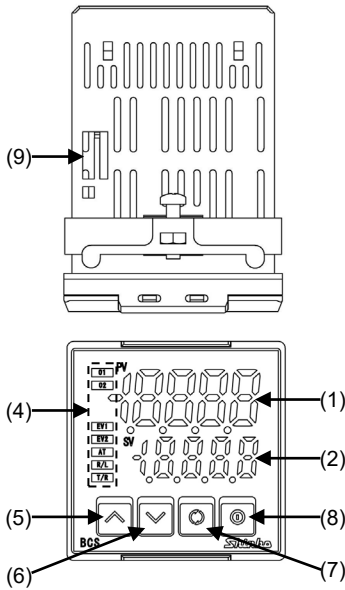

BCR2

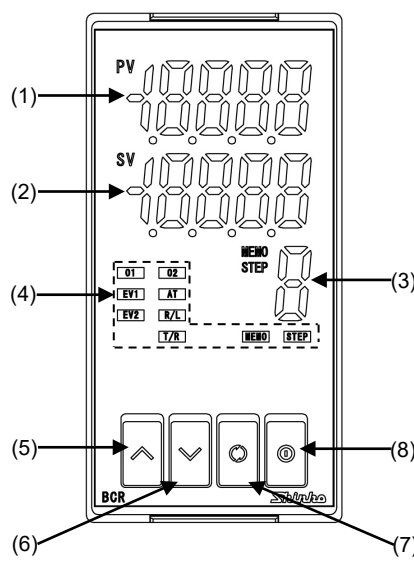

BCD2

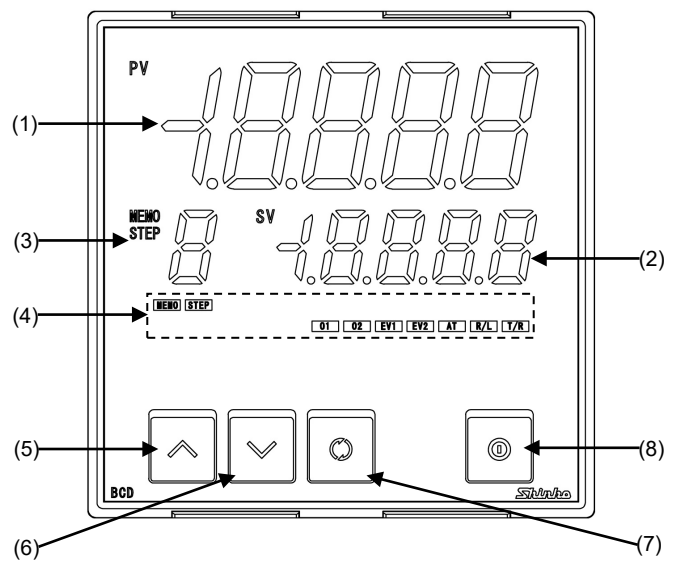

Displays

(1)	PV Display	Indicates the PV (process variable), or setting characters in setting mode.
(2)	SV Display	Indicates the SV (desired value) or set data in setting mode. In Monitor mode, indicates MV (manipulated variable), remaining time (Program control), step number (Program control) (*) or Set value memory number (Fixed value control) (*). (*) For BCS2 only
(3)	MEMO/STEP Display	Indicates Set value memory number or step number (Program control). (For BCR2, BCD2)

Action Indicators

(4)	O1	Lit when control output OUT1 is ON. For direct current output type, flashes corresponding to the MV in 125 ms cycles.
	O2	Lit when control output OUT2 (EV2, DS, DA or EV2+D□ option) is ON. For direct current output type, flashes corresponding to the MV in 125 ms cycles.
	EV1	Lit when Event output 1 is ON.
	EV2	Lit when Event output 2 (EV2 or EV2+D□ option) is ON.
	AT	Flashes while AT or Auto-reset is performing.
	R/L	Lit while in Remote action (EIT option).
	T/R	Lit during Serial communication (C5W or C5 option) TX (transmitting) output.
	MEMO	Lit when Set value memory number is indicated. (For BCR2, BCD2)
	STEP	Lit when Step number (Program control) is indicated. (For BCR2, BCD2)

Keys, Connector

(5)	UP key	Increases the numeric value. If this key is pressed for 1 sec during Program control, the unit proceeds to the next step. (Advance function)
(6)	DOWN key	Decreases the numeric value.
(7)	MODE key	Selects a setting mode, and registers the set data. If the MODE key is pressed in RUN mode for 3 sec, the unit moves to Monitor mode.
(8)	OUT/OFF key	By pressing this key for 1 sec, one of the following items selected in [OUT/OFF key function] is indicated. • Control output OFF function: Turns control output ON or OFF. • Auto/Manual control: Switches the Auto/Manual control. • Program control: Starts or stops the Program control.
(9)	Console connector	By connecting to the tool cable (CMD-001, sold separately), the following operations can be conducted from an external computer using the Console software SWC-BCx01M. • Reading and setting of SV, PID and various set values • Reading of PV and action status • Function change. (Console connector is located on the top of the BCS2, BCR2, and BCD2 case.)

Terminal Arrangement

BCS2

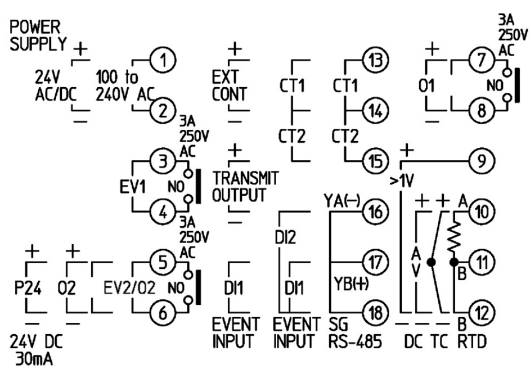

BCR2, BCD2

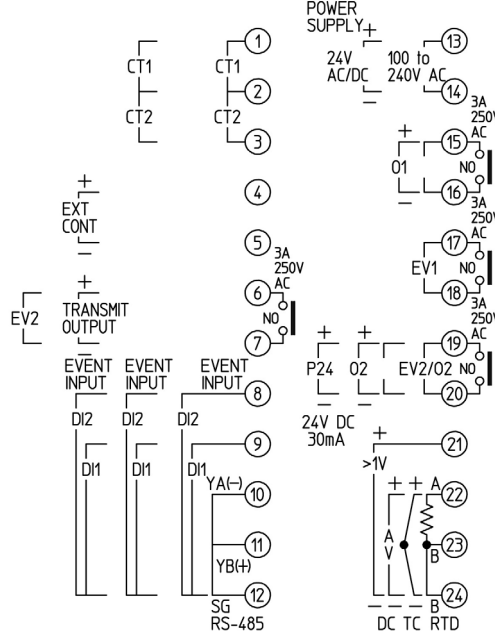

POWER SUPPLY	Supply voltage 100 to 240 V AC or 24V AC/DC (For 24 V DC, ensure polarity is correct.)
EV1	Event output EV1
EV2	Event output EV2 (EV2, EV2+D□ options)
O2	Control output OUT2 (EV2, DS, DA, EV2+D□ options)
P24	24 V DC Insulated power output (P24 option)
O1	Control output OUT1
TC	Thermocouple input
RTD	RTD input
DC	DC voltage, current input
CT1	CT input 1 (C5W, EIW, W options)
CT2	CT input 2 (C5W, EIW, W options)
RS-485	Serial communication RS-485 (C5W, C5 options)
EVENT INPUT	Event input DI1 (C5W, EIW, EIT, EI options) (C5W: For BCR2, BCD2) Event input DI2 (C5W, EIW, EIT, EI options) (C5W, EIT: For BCR2, BCD2)
EXT CONT	External setting input (EIT option)
TRANSMIT OUTPUT	Transmission output (EIT option)

Caution
Do not pull or bend the lead wire on the terminal side when wiring or after wiring, as it could cause malfunction.

Key Operation Flowchart

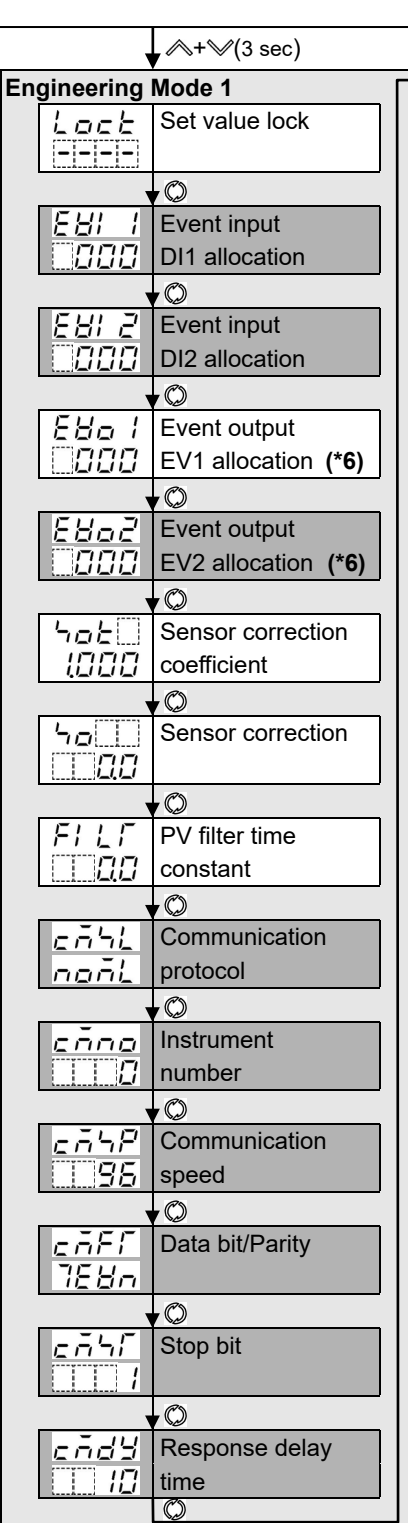
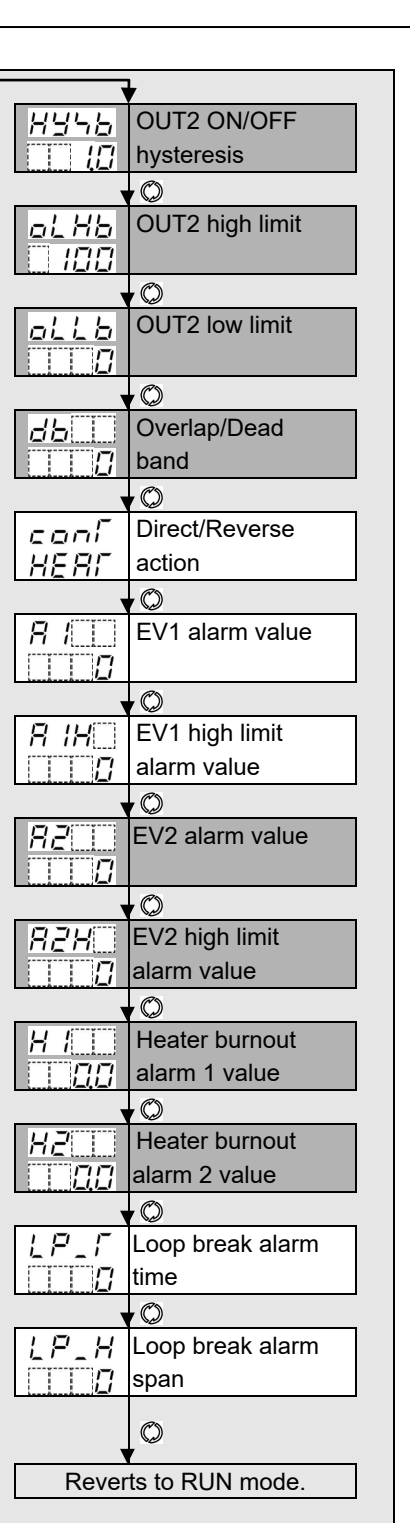
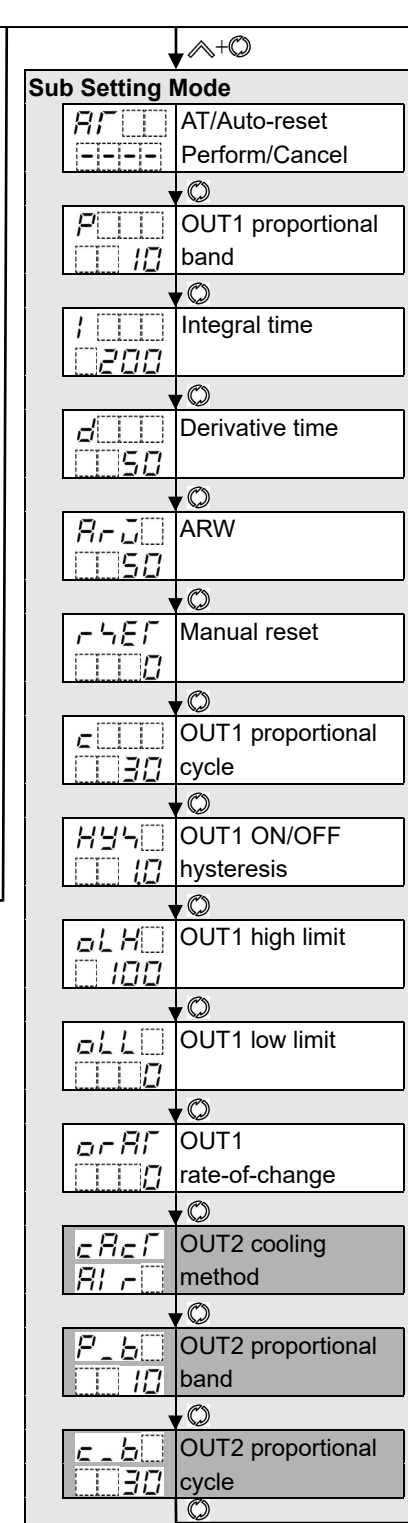
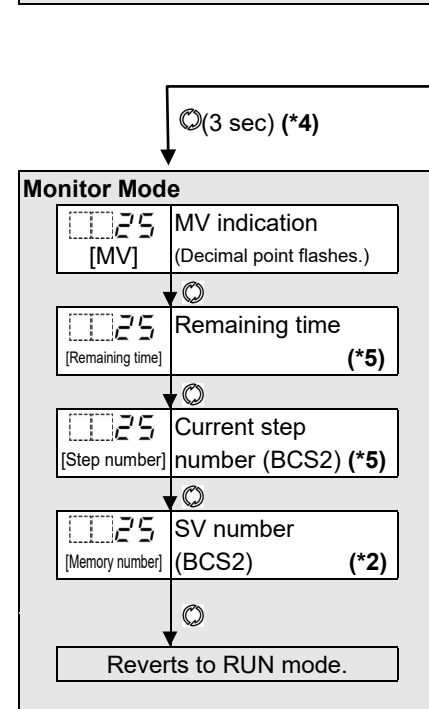
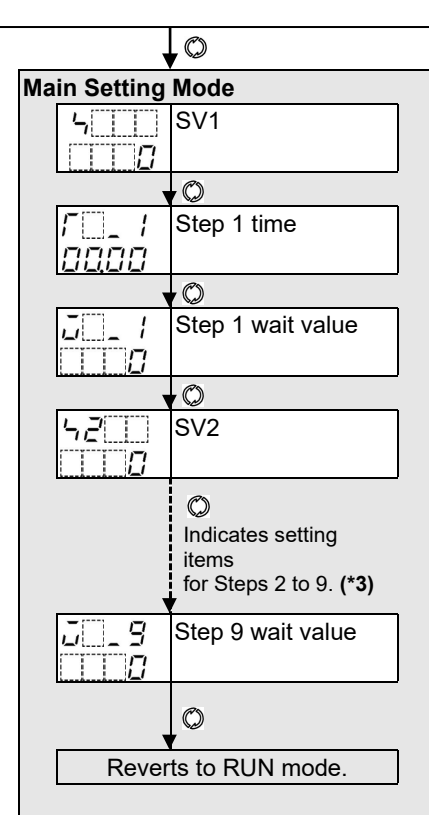
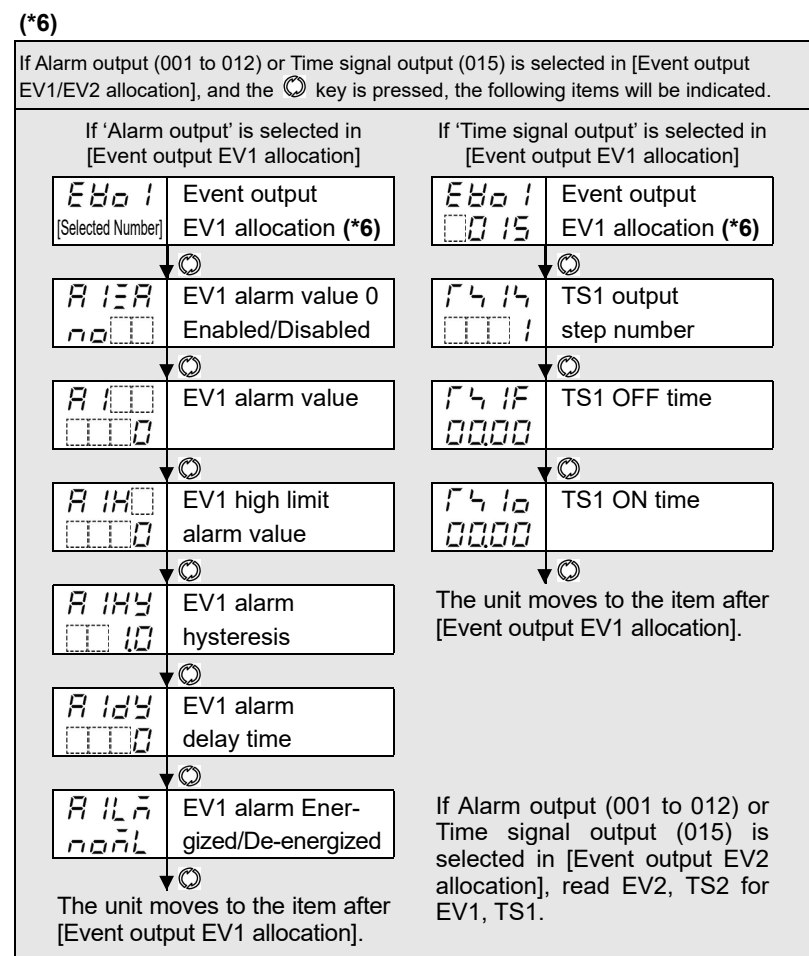
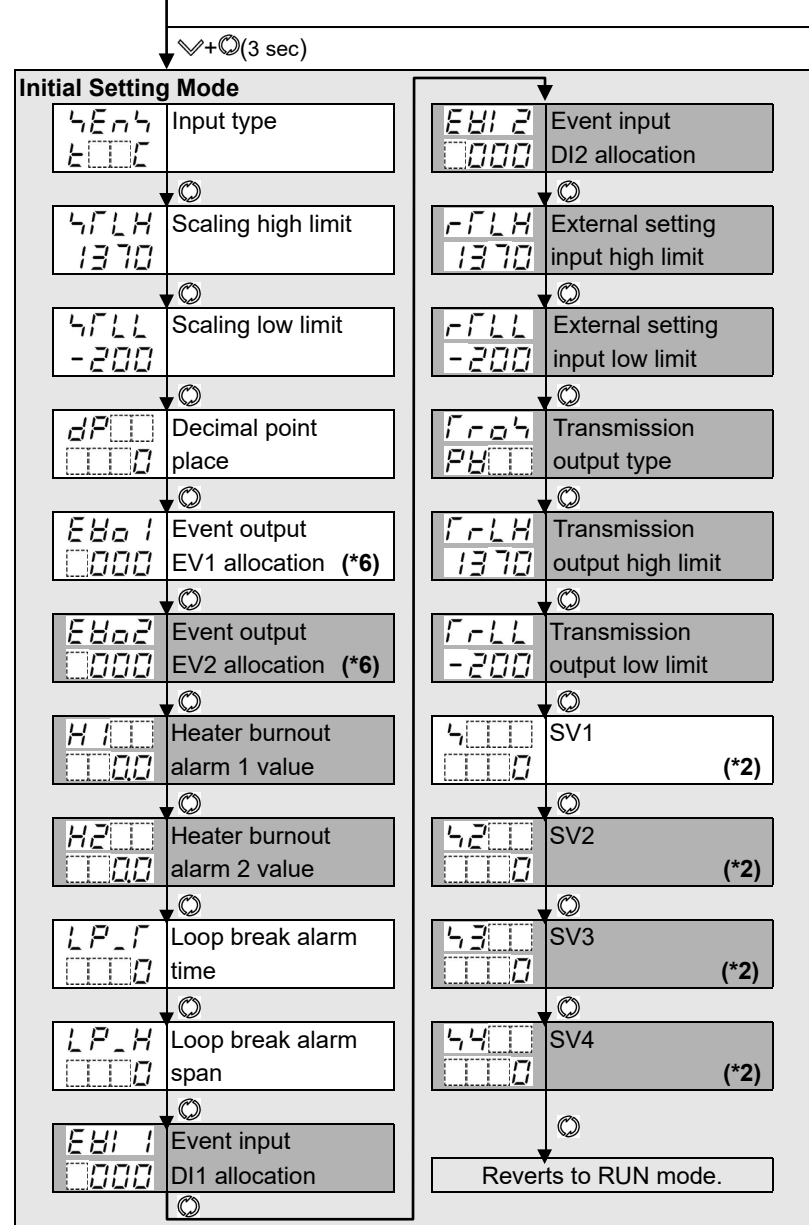
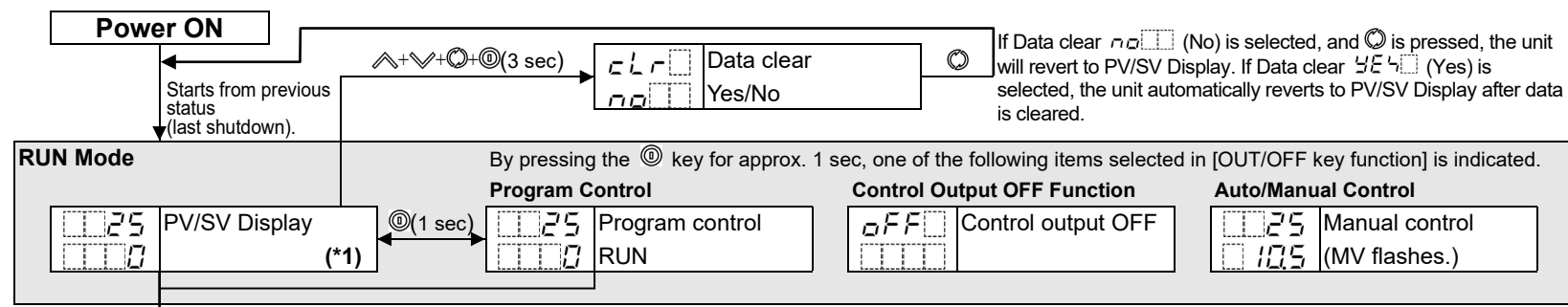

About Setting Item

- Input type: Upper left: PV Display: Indicates setting characters. Lower left: SV Display: Indicates factory default. Right side: Indicates the setting item.
- (*) If 'Program control' is selected in [OUT/OFF key function], the unit enters Standby mode (Program control waiting).
- (*)2 Not available if 'Program control' is selected in [OUT/OFF key function].
- (*)3 If the option is ordered, and if 'Set value memory' is selected in [Event input DI1/DI2 allocation], setting items SV2 to SV4 are available. If 'Program control' is selected in [OUT/OFF key function], SV2 to SV9, Steps 1 to 9 wait value are available.
- (*)4 The unit cannot proceed to Monitor mode if it is in Standby of Program control.
- (*)5 Available only when 'Program control' is selected in [OUT/OFF key function].

Key Operation

- Press and hold (up, down, left, right) keys (in that order) together for approx. 3 sec.
- Press and hold (up, down, left, right) keys (in that order) together for approx. 3 sec.
- Press and hold the (up, down) keys (in that order) together.
- Press and hold the (up, down) keys (in that order) together for approx. 3 sec.
- Press and hold the (up, down) and (left, right) keys (in that order) together for approx. 5 sec.
- Set (or select) each item with the (up, down) key, and register the value with the (enter) key.
- If the (enter) key is pressed, the unit proceeds to the next item, illustrated by an arrow. Pressing (enter) key moves back to the previous item.
- To revert to RUN mode, press and hold the (enter) key for approx. 3 sec while in any mode.
- To revert to RUN mode, press and hold the (enter) key for approx. 3 sec while in any mode. If 'Control output OFF function' is selected in [OUT/OFF key function], the unit will enter Control output OFF status. If 'Auto/Manual control' is selected, the unit will enter Manual control status. If 'Program control' is selected, the unit will enter Program control RUN or Standby mode.

Input type	PT	-328.0 to 752.0 °F	003	H/L limits alarm	no	Disabled	PV	PV transmission	2	2 bits	PVRL	PV + Any Alarm active
K	N	-328 to 2372 °F	004	H/L limits independent	ye	Enabled	SV	SV transmission	ye	Remote/Local	l	Output status when input errors occur
K	PL-II	32 to 2534 °F	005	H/L limit range alarm	no	Disabled	MV	MV transmission	no	Local	o	Output OFF
J	C(W/Re5-26)	32 to 4199 °F	006	H/L limit range independent	no	Disabled	DV	DV transmission	no	Remote	o	Output ON
R	Pt100	-328.0 to 1562.0 °F	007	Process high alarm	no	Disabled	AT	AT/Auto-reset Perform/Cancel	no	Step time unit	o	OUT/OFF key function
S	JPt100	-328.0 to 932.0 °F	008	Process low alarm	no	Disabled	AT	AT/Auto-reset Cancel	no	Hours:Minutes	o	Control output OFF
B	Pt100	-328 to 1562 °F	009	High limit with standby	no	Disabled	AT	AT on startup Perform	no	Minutes:Seconds	o	Control output OFF
E	JPt100	-328 to 932 °F	010	Low limit with standby	no	Disabled	AR	Auto-reset Perform	no	Power restore action	no	Auto/Manual control
T	Pt100	-200.0 to 850.0 °C	011	H/L limits with standby	no	Disabled	AR	Auto-reset Perform	no	Stop	no	Program control
N	Pt100	-200 to 1300 °C	012	H/L limits with standby independent	no	Disabled	OUT2	OUT2 cooling method	no	Continue (resume)	no	Auto/Manual control after power ON
PL-II	0	to 1390 °C	013	Heater burnout alarm output	no	Disabled	RI	Air cooling	no	Hold	no	Automatic control
C(W/Re5-26)	0	to 2315 °C	014	Loop break alarm output	no	Disabled	oil	Oil cooling	no	Program control start type	no	Manual control
Pt100	-200.0 to 850.0 °C		015	Time signal output	no	Disabled	water	Water cooling	no	PV start	no	Controller/Converter function
JPt100	-200.0 to 500.0 °C		016	Output during AT	no	Disabled	Direct/Reverse	Direct/Reverse action	no	PVR start	no	Controller
JPt100	-200 to 500 °C		017	Pattern end output	no	Disabled	HEAR	Reverse action	no	SV start	no	Converter
K	-328 to 2498 °F		018	Output by communication command	no	Disabled	Direct	Direct action	no	SV Rise/Fall rate start type	no	Error indication Enabled/Disabled
K	-328.0 to 752.0 °F		019	Heating/Cooling control relay contact output (for EV2 only)	no	Disabled	Lock	Set value lock	no	SV start	no	Disabled
J	-328 to 1832 °F				no	Disabled	Lock 1	Unlock	no	PV start	no	Enabled
J	-328 to 1832 °F				no	Disabled	Lock 2	Lock 1	no	Indication when control output OFF	no	Control method
R	32 to 3200 °F				no	Disabled	Lock 3	Lock 2	no	OFF indication	no	Usual PID
S	32 to 3200 °F				no	Disabled	Lock 4	Lock 3	no	No indication	no	2DOF PID
B	32 to 3308 °F				no	Disabled	Lock 5	Lock 4	no	PV indication	no	
E	-328 to 1472 °F				no	Disabled	Lock 5	Lock 5	no	1 bit		