

**INSTRUCTION MANUAL
FOR
MICROCOMPUTER BASED
HAND HELD TYPE
DIGITAL HYGROTHERMO INDICATOR
DFT-600-TH**

Thank you for your purchase of our Microcomputer based Hand held type Digital Hygrothermo indicator DFT-600-TH. This manual contains instructions for the functions and operation of the DFT-600-TH.

For your confirmation of the model and specifications of the indicator, peruse and understand this instruction manual before starting operation.

Please arrange to give this manual into the hands of the operator who actually uses our product.

Introduction	3
1. DFT-600-TH and the accessories	3
2. Name of the sections	4
3. Before using	5
4. Preparations for measurement	
4.1 Dry battery putting method	10
4.2 Sensor probe mounting	11
5. Measurement	
5.1 Display	12
5.2 Switch	12
5.3 Measurement	13
5.4 Other indications	14
6. Sensor exchange	16
7. Other notices	18
Life of humidity sensor	19
8. External dimension	20
9. Specifications	
9.1 DFT-600-TH	21
9.2 THD-600-P	23

Introduction

This hand held type indicator is designed to indicate the temperature and the humidity simultaneously, and the humidity sensor is required no calibration, interchangeable sensors by the plug-in system and long life battery by the slight power consumption.

1. DFT-600-TH and the accessories

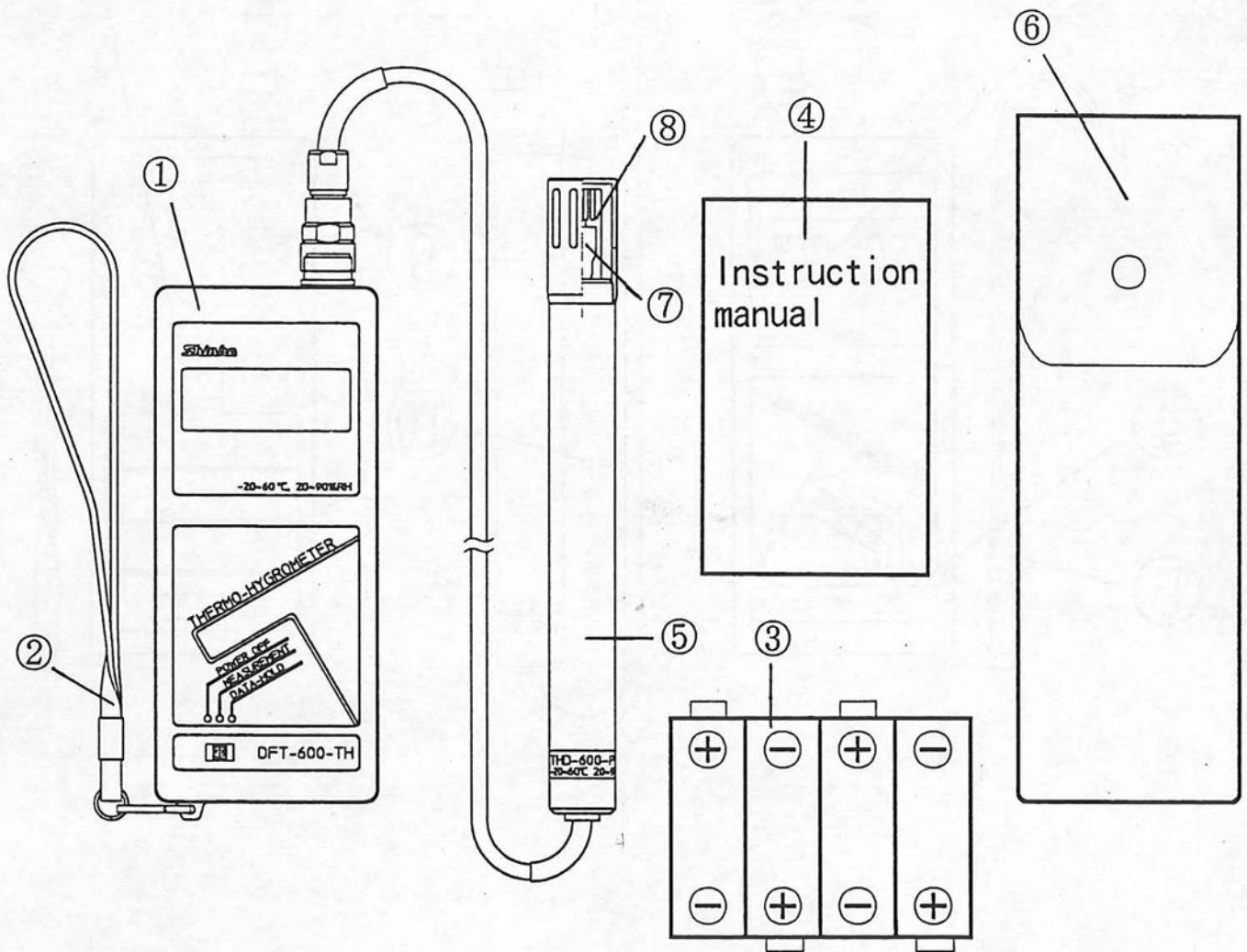

- ① DFT-600-TH
- ② Wrist strap
- ③ Dry batteries (R6P ×4)
- ④ Instruction manual

- ⑤ Sensor probe (THD-600-P)
- ⑥ Vinyl case for probe
- ⑦ Temperature sensor (TD-S) *
- ⑧ Humidity sensor (HD-S) *

*: They are already mounted to the sensor probe.

2. Name of the sections

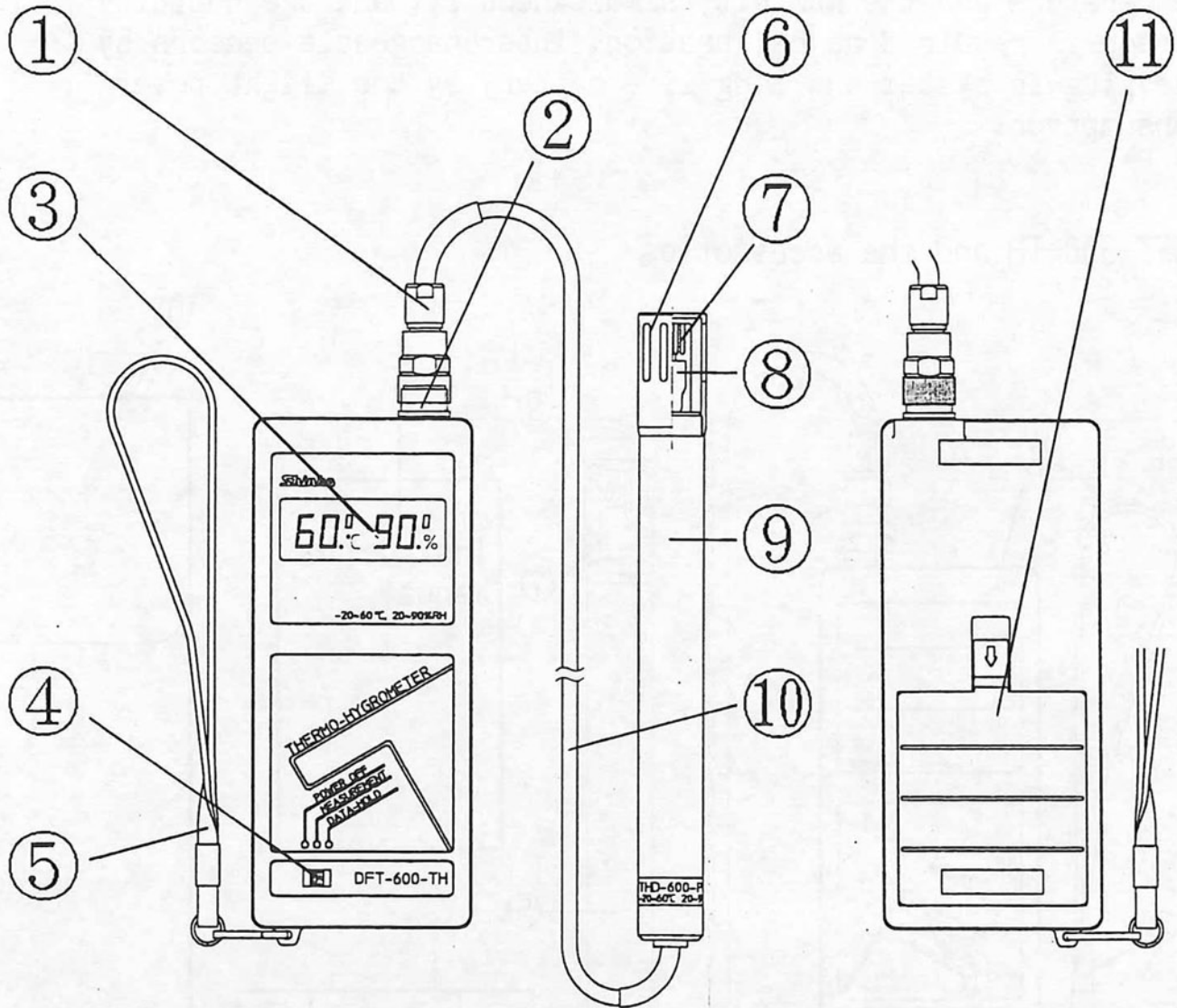

- | | | |
|--------------|----------------------|--------------------------|
| ① Plug | ⑤ Wrist strap | ⑨ Grip |
| ② Receptacle | ⑥ Cap | ⑩ Heat proof rubber cord |
| ③ Display | ⑦ Humidity sensor | ⑪ Battery cover |
| ④ Switch | ⑧ Temperature sensor | |

3. Before using

When using, follow the undermentioned items. They are to prevent the failure and to keep the correct measurement.

Do not use the battery except R6P or LR6 type.

External power source must not be used.

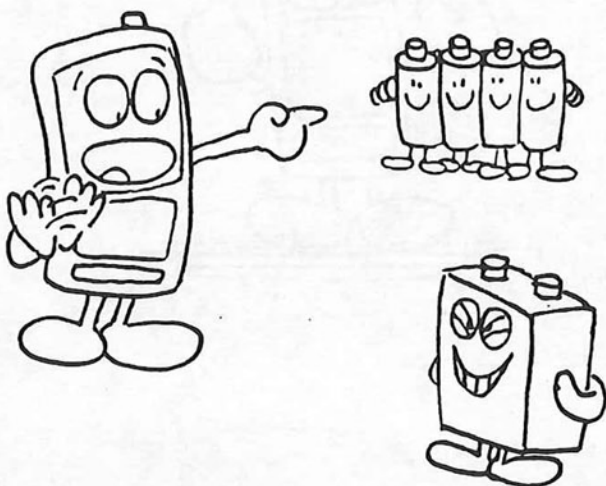

Sensor probe to fit the DFT-600-TH is THD-600-P. Do not use other type.

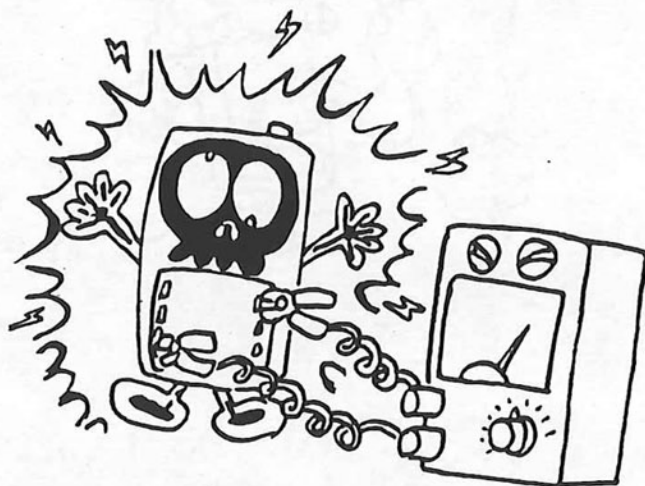

No display will appear for approx. 5 seconds after the switch is turned on. It is not failure but the microcomputer is preparing.

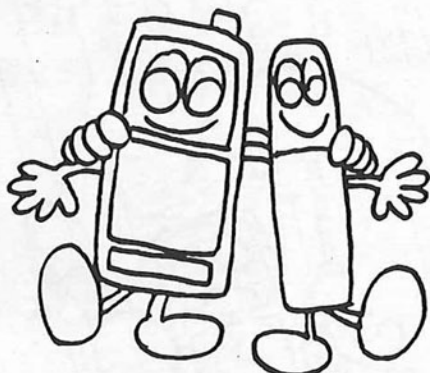

Do not use the indicator in an atmosphere corrosive gas or much dust is found.



Do not use the indicator at the place vibrating or shocking.



Do not leave the indicator at the place directly exposed to the sun for a long time.

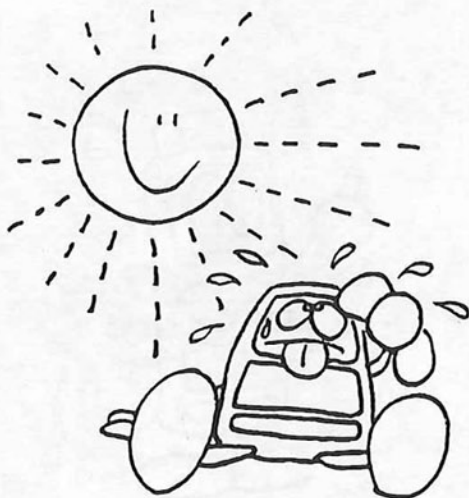

Do not use the indicator in an atmosphere high temperature or high humidity.



Measurement less than -20°C cannot be performed. The temperature display is held at -20°C .



Measurement more than 60°C cannot be performed. The temperature display is held at 60°C .

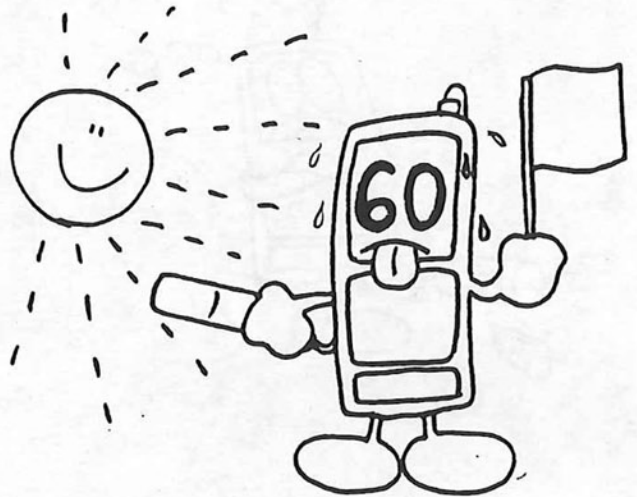

Correct humidity sensing cannot be performed at less than 20%RH. The display is inaccurate.

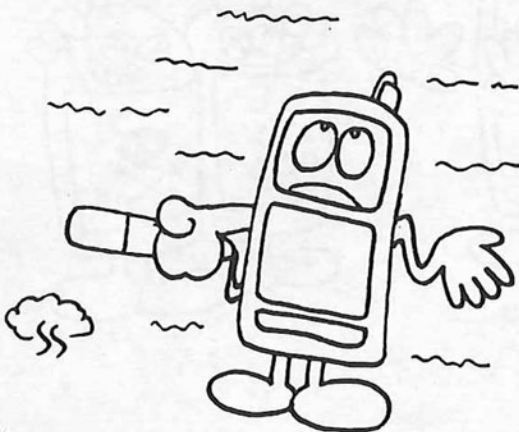

Humidity sensor will be degraded at more than 95%RH. The display becomes inaccurate as well. When the sensor is condensed, it exceeds 100, and sometimes it displays 06.5 (106.5) and so on.

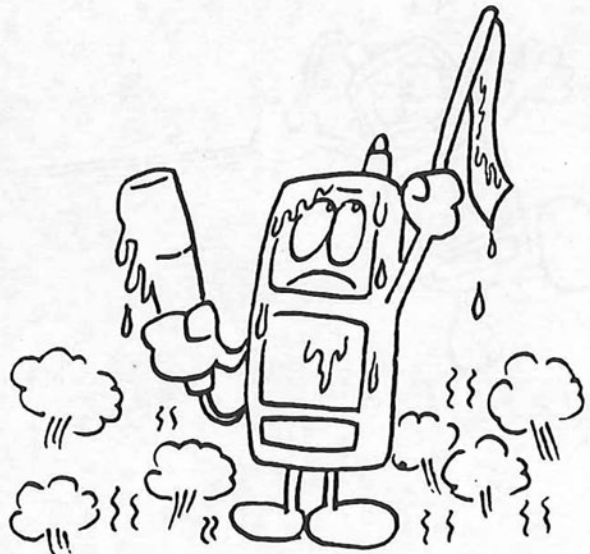

Do not use the indicator removing the probe, or the probe removing the sensor.



Do not disassemble the indicator and the sensor.

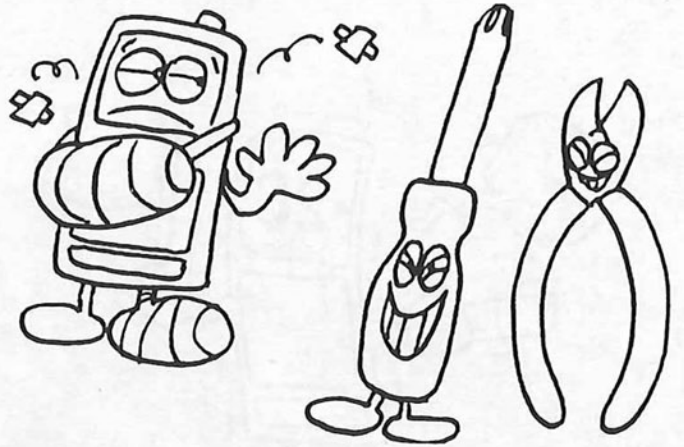

Do not give a strong pull at the probe cord, or the wire in the cord may be broken.



Do not use the thinner, benzine, etc. to clean dirt. Use soft cloth soaked with neutral detergent diluted.

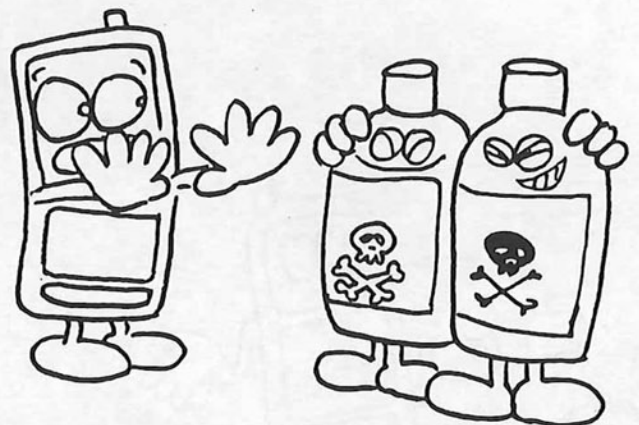

When turning the switch on, if moved by excessive force, it goes to DATA-HOLD. For correct measurement, stop the switch at MEASUREMENT. When it passed, switch on again.



If you forget to turn the switch off and leave the indicator for a long time, the dry battery may be discharged, and BAT mark may not appear.

If it is left, it may cause the liquid spill, and it may lead the instrument inner side to corrosion.

Exchange the battery to new one as soon as possible.



When measuring near the noise source, display error or malfunction will be caused occasionally. In such a case, turn the switch off and on again.

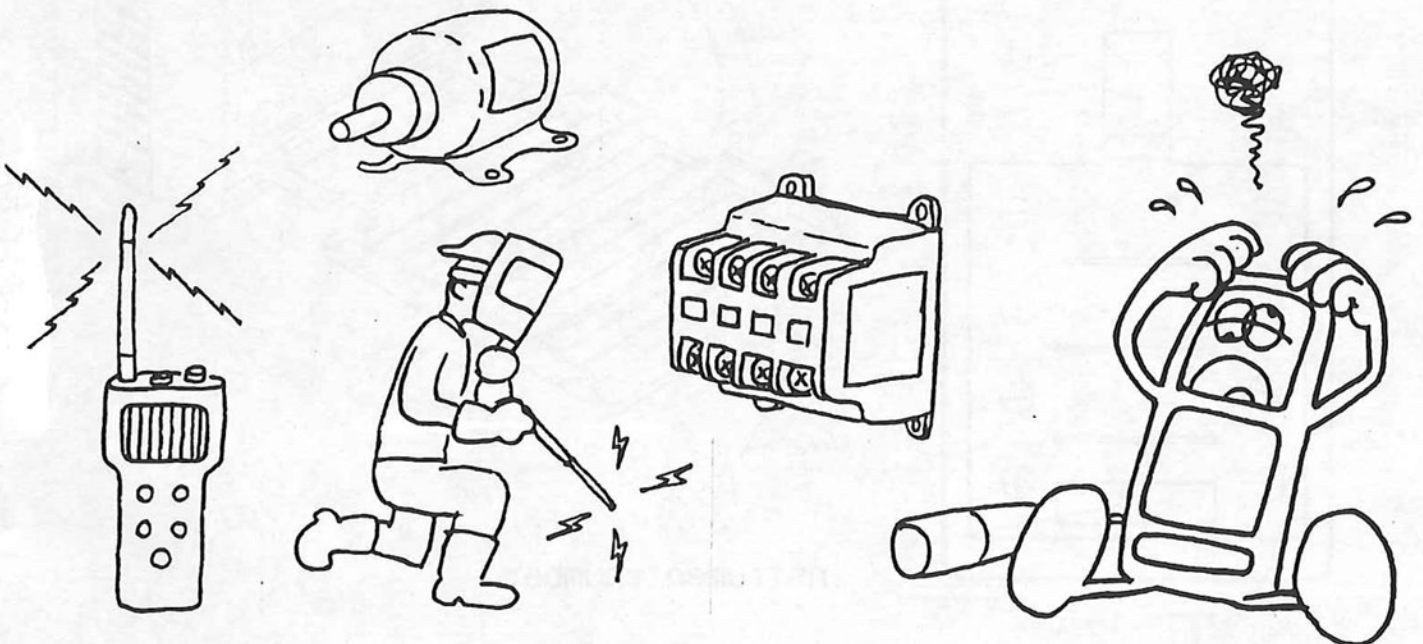

4. Preparations for measurement

4.1 Dry battery putting method

- (1) Remove the battery cover pulling the hook by finger.
- (2) Put the attached dry battery into the battery holder making sure the polarity as shown figure.
- (3) After the batteries are set, close the battery cover fitting the cover to the slot located bottom of holder and push until it sounds click.

Note:

Use the same type of dry batteries, and do not use the batteries together new one and old one.

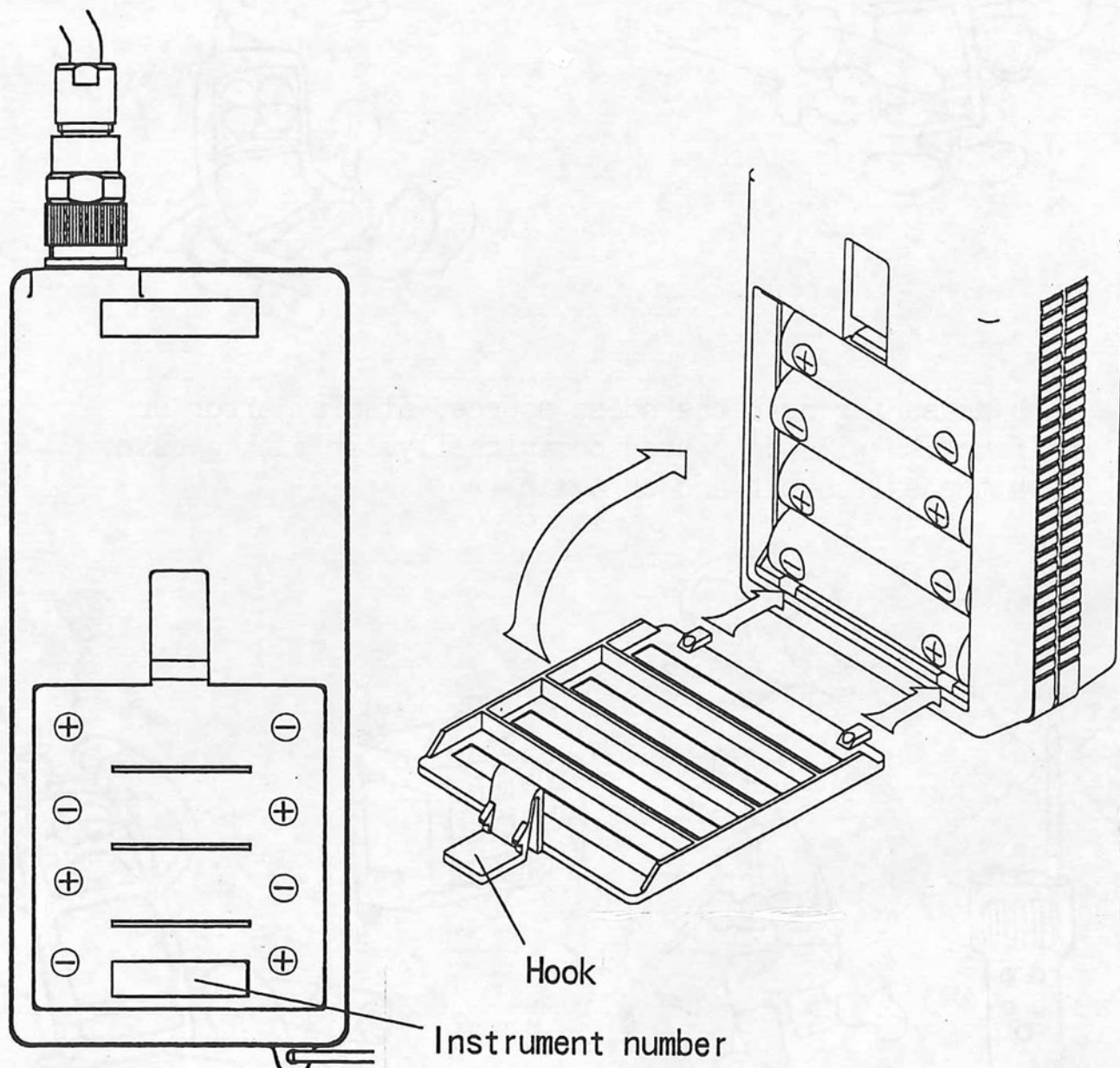

4.2 Sensor probe mounting

- (1) Insert the plug of the sensor probe into the receptacle of the DFT-600-TH by fitting the slot.
- (2) Fasten the plug with the clamping ring by turning to clockwise.

When removing the probe, loosen the clamping ring by turning to counter clockwise, and take the plug off straight.

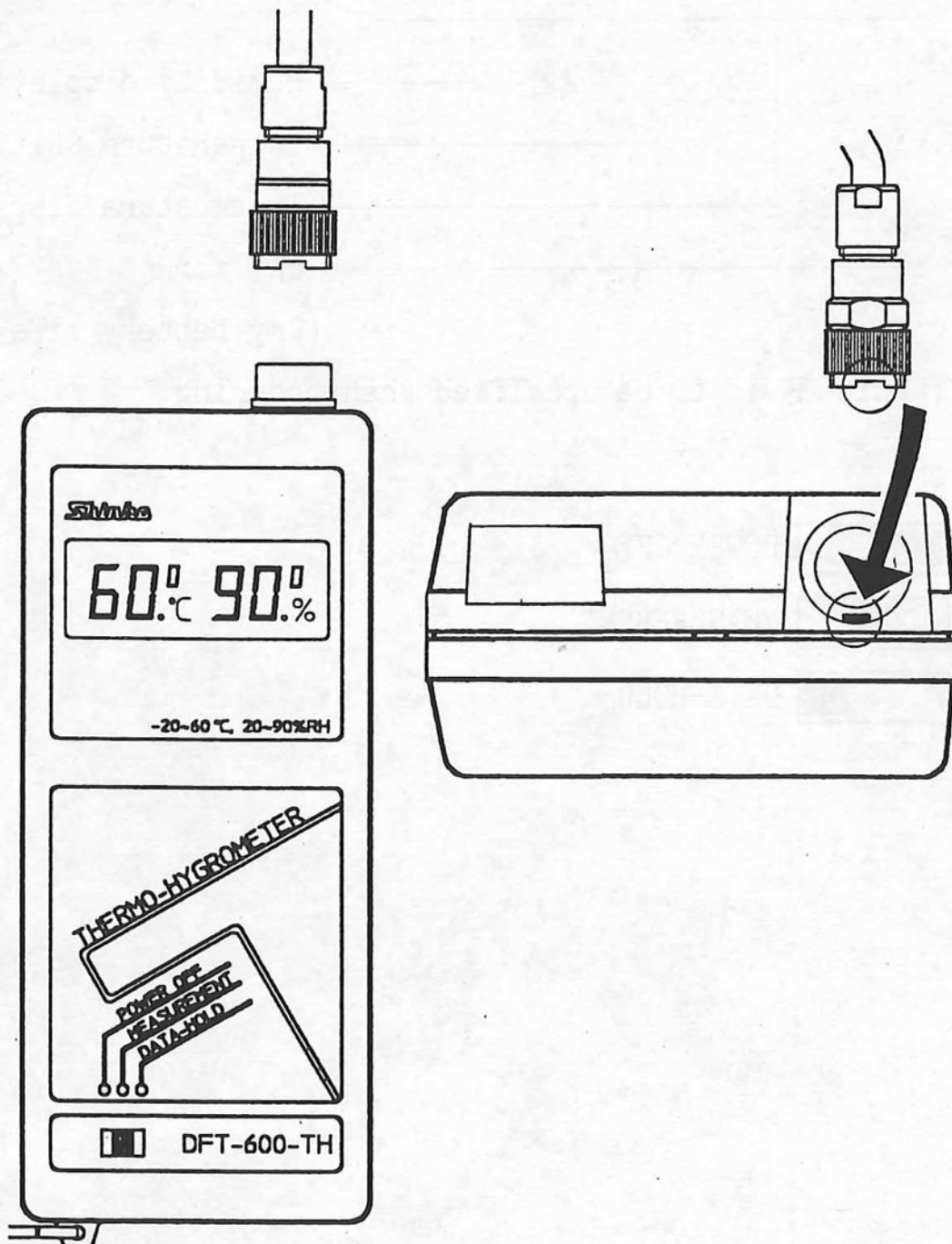

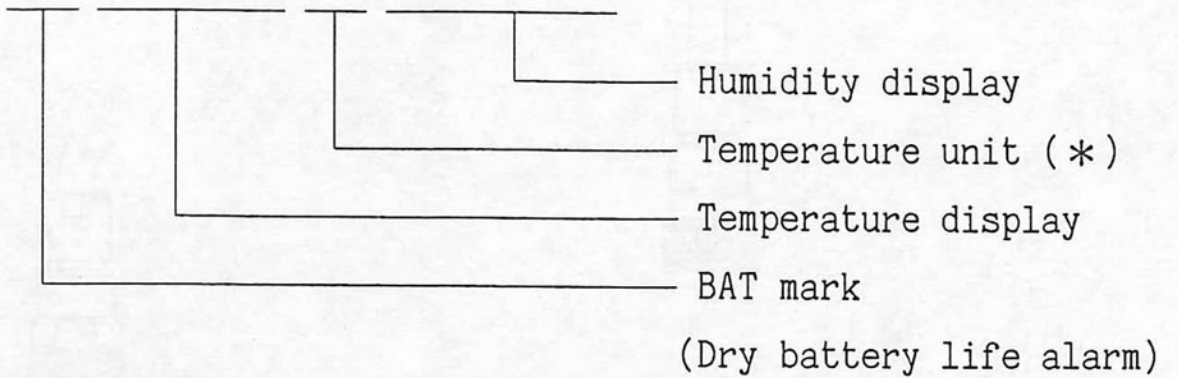
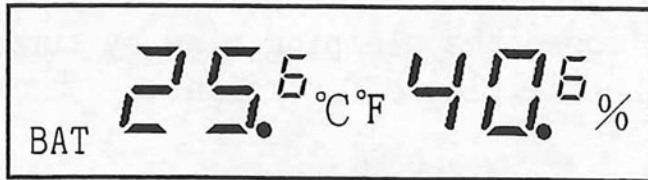

5. Measurement

5.1 Display



(*): Unit °F is to be specified when ordering.

5.2 Switch

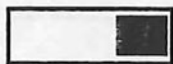
-  POWER OFF
-  MEASUREMENT
-  DATA-HOLD

5.3 Measurement

(1) Turn the switch to MEASUREMENT.



- Wait for approximately 5 seconds. No display is indicated at this time, however, it is not failure but the microcomputer is now warming up.

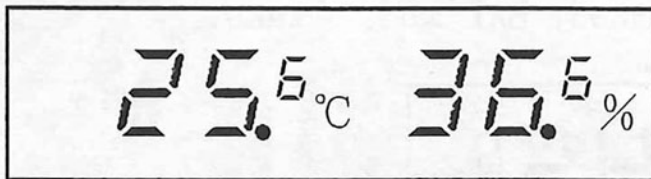

Measured temperature and humidity are displayed

- If the switch is turned off and turned on again at once, the time until starting display becomes a little shorter.
- After the display is indicated, it will fluctuate for several seconds until it stabilizes.

(2) When holding measured temperature and humidity value, turn the switch to DATA-HOLD (right end).



- To release the Hold function, return the switch to MEASUREMENT. The indicator continues the measurement during hold, therefore, sometimes the value changes greatly after released.
- When holding at the temperature 0°C or less, sometimes the marks [°C or °F] and [L] are displayed and sometimes they are not, however, it is not malfunction.

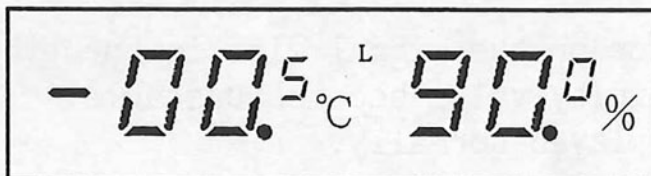

or

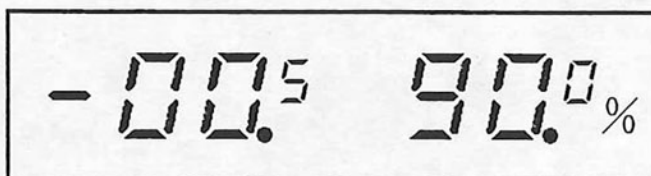

- (3) When the measurement is finished, always turn the switch to POWER OFF (left end) to prevent battery consumption.

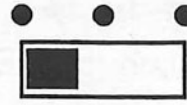

5.4 Other indications

- (1) When the battery is consumed, BAT mark blinks.

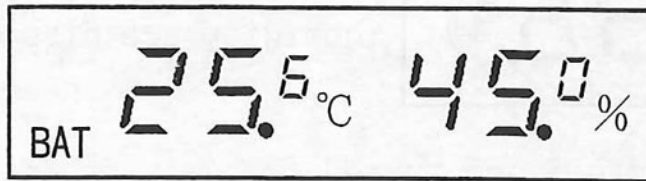

- If the indicator is left setting the switch to MEASUREMENT or DATA-HOLD for a long time, the battery will be exhausted, and the BAT mark will not blink.

When the BAT mark is found, exchange the battery to new one as soon as possible.

- (2) When the temperature sensor or the signal wire is burnt out, the temperature display is fixed at 60.0°C. The humidity is displayed normally.

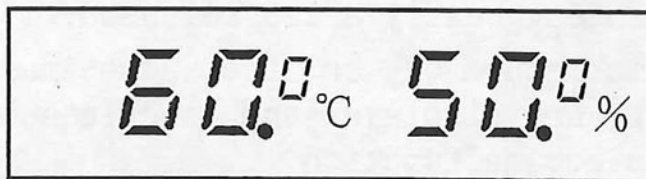

- (3) When the humidity sensor or the signal wire is burnt out, the display of the humidity value becomes unstable. The temperature is displayed normally.

- (4) When the measuring temperature falls -0.1°C or less, the displays [L] and [$^{\circ}\text{C}$ or $^{\circ}\text{F}$] blink on the temperature side, and [AL] is displayed on the humidity side, however, this [AL] has no meaning to this indicator.

When the ambient temperature rises more than 0°C , the display [L] will go out, however, [AL] will remain unless the power is turned off.

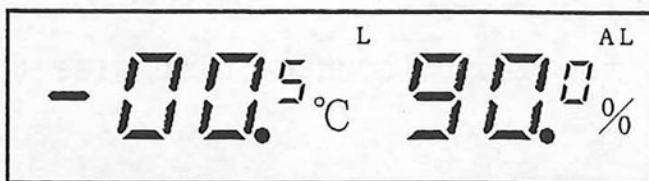

- (5) When the measuring temperature is less than -20°C or more than 60°C , the display will be fixed at -20.0°C or 60.0°C . Display underscale or overscale to show that the value is exceeding the range is not provided.
- (6) When measuring more than 95%RH, the humidity display will exceed 100, however, the digit 100 is not displayed.

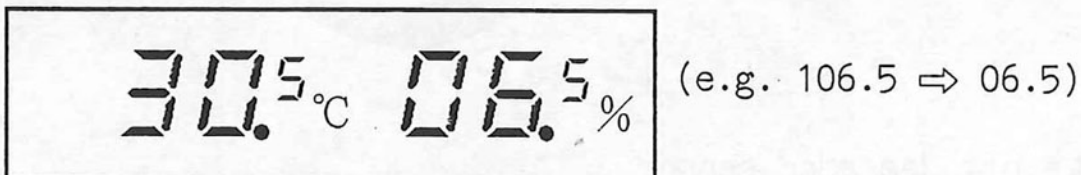

6. Sensor exchange

- The temperature sensor and the humidity sensor are interchangeable, and they need no calibration when exchanged. They can be used at once after exchange.
- Take care not to stain the socket and sensor terminal (leg). If stained, it causes disconnection.

(1) Take off the cap

Take the cap off turning the cap to counter clockwise (arrow direction).

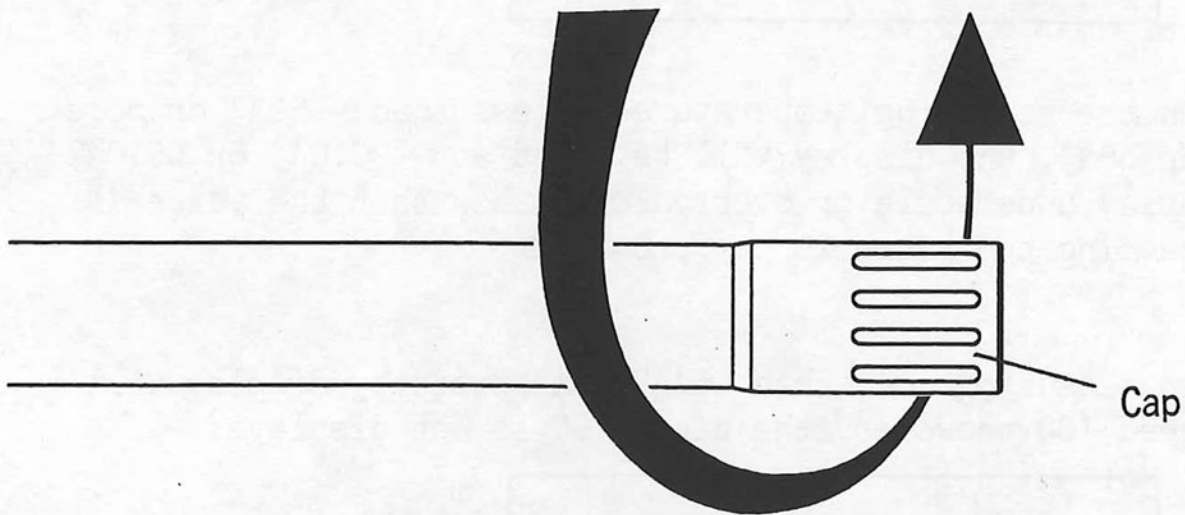

(2) Take off degraded sensor

Pull out the sensor vertically.

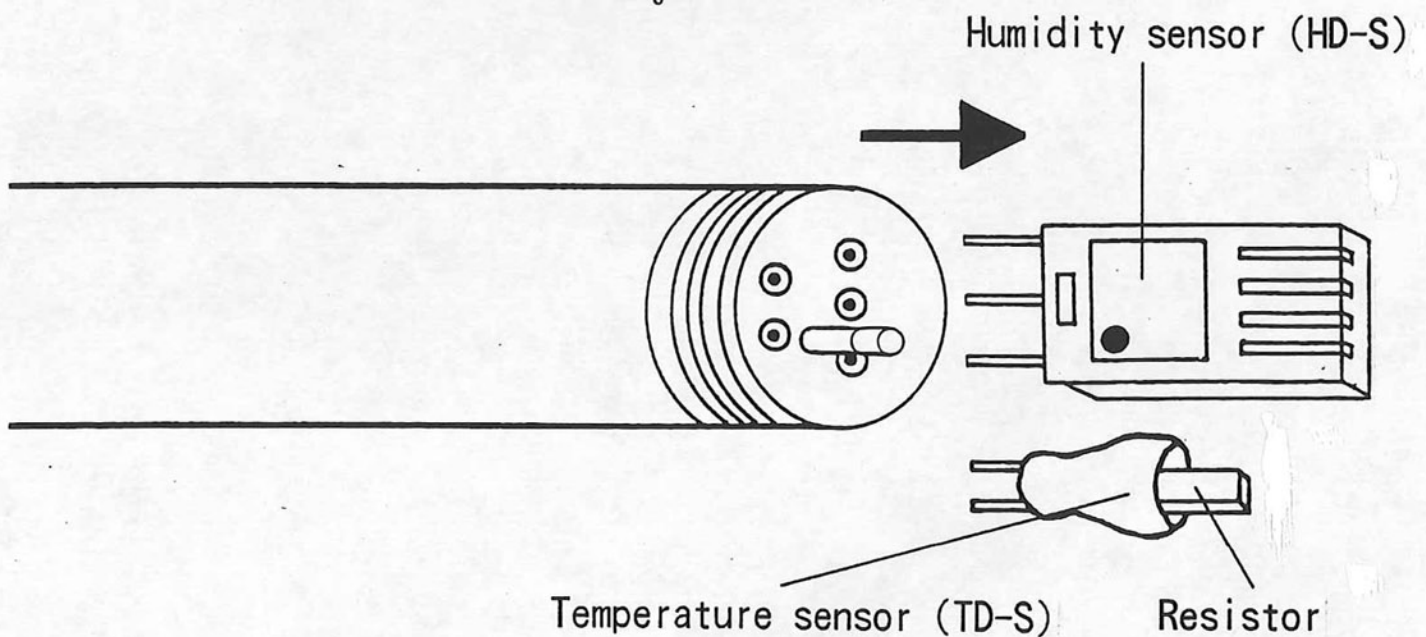

(3) Mount new temperature sensor

Temperature sensor has no polarity.

Insert the sensor to the pin socket for temperature vertically.

Do not touch the resistor parts, or it will cause error.

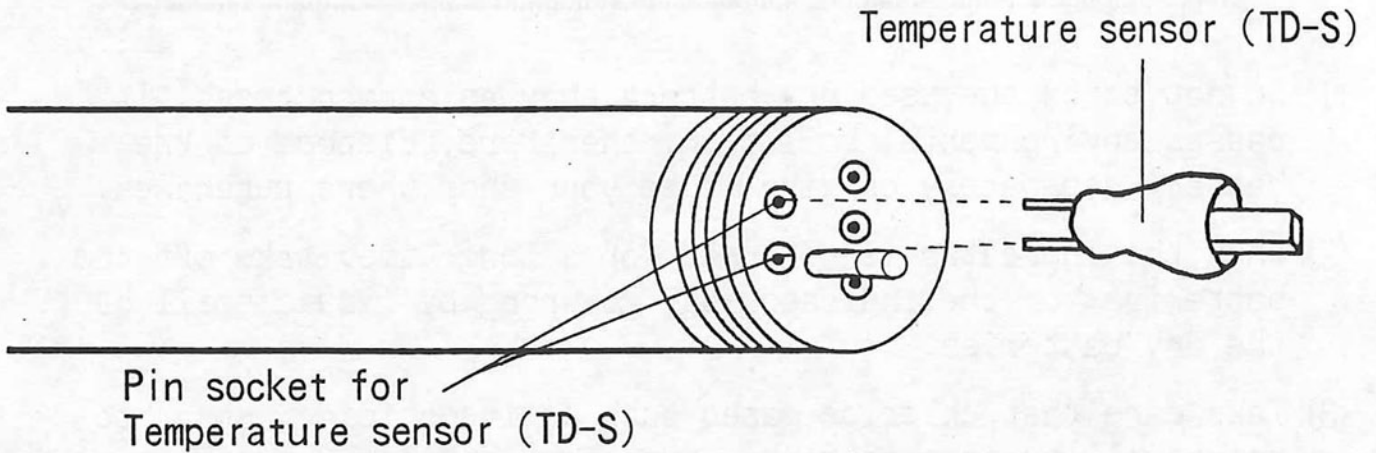

(4) Mount new humidity sensor

Humidity sensor has polarity.

Insert the sensor to the pin socket for humidity vertically.

The label (Positioning mark) side should face to the reverse insertion preventing pin.

When inserting reverse, the pin prevents the insertion.

If it is inserted by force, the sensor will be broken.

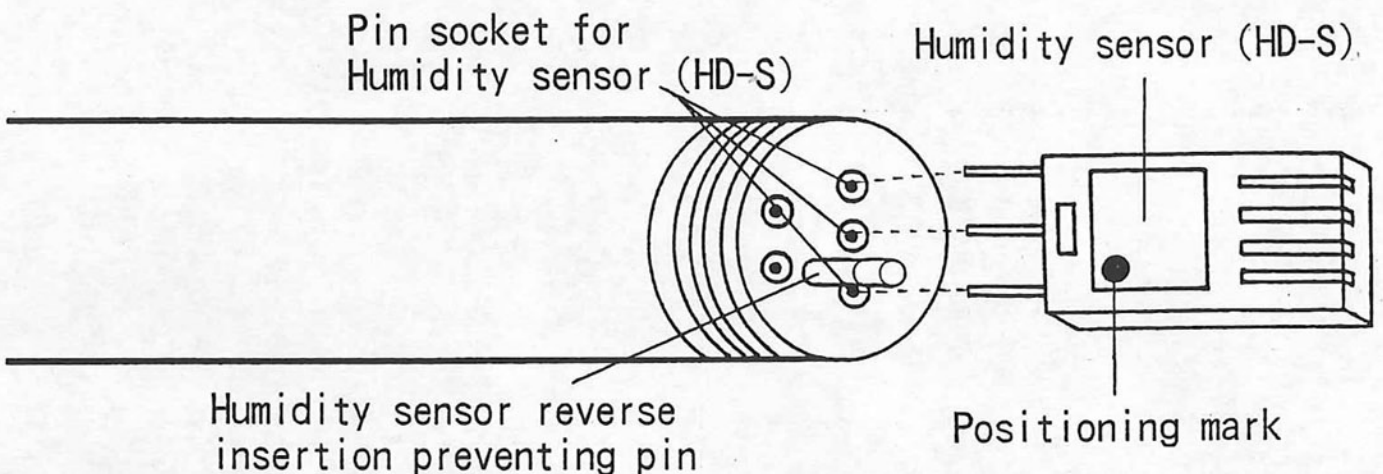

○ When ordering the exchanging sensor

We can sell only sensor or only sensor probe.

Designate the model names undermentioned.

Sensor probe : THD-600-P

Temperature sensor: TD-S

Humidity sensor : HD-S

7. Other notices

..... <Notice>

The dry battery (R6P or LR6) must not be charged,
or it may cause an accident.

- (1) Do not throw the used dry battery away as common trash. It causes environmental pollution, therefore, dispose of the battery separately or give it to your shop where purchased.
- (2) When the indicator is not used for a long time, take off the batteries, or the indicator may go wrong by liquid spill of the dry batteries.
- (3) Take care that chloride gases such as insecticide, spray to paint wall or some solvents cause degradation of humidity sensor.
- (4) The liquid crystal display of this indicator has the direction easy to see. It is ideal angle to see from this side 80 to 50° to the display face. (Raise the wrist strap side up.)
In dark place, the display is difficult to see, since back light is not provided to this display.

Life of humidity sensor

The humidity sensor is mounted in the case, however, the sensing face must be exposed to the air, therefore drip-proof treatment cannot be applied. For this reason, the life is greatly different from the environment of the measuring location or using condition. It is difficult to state the life time by numeral.

[Reference] Data for the humidity sensor in gas atmosphere.

HCl (Hydrogen chloride)	5ppm	40°C	80%RH	for approx. 100h, error -10%RH
SO ₂ (Sulfur dioxide)	5ppm	40°C	80%RH	for approx. 100h, error -10%RH
Cl (Chlorine)	5ppm	40°C	80%RH	for approx. 100h, error +10%RH
H ₂ S (Hydrogen sulfide)	50ppm	40°C	80%RH	for approx. 200h, error ±1%RH

8. External dimension

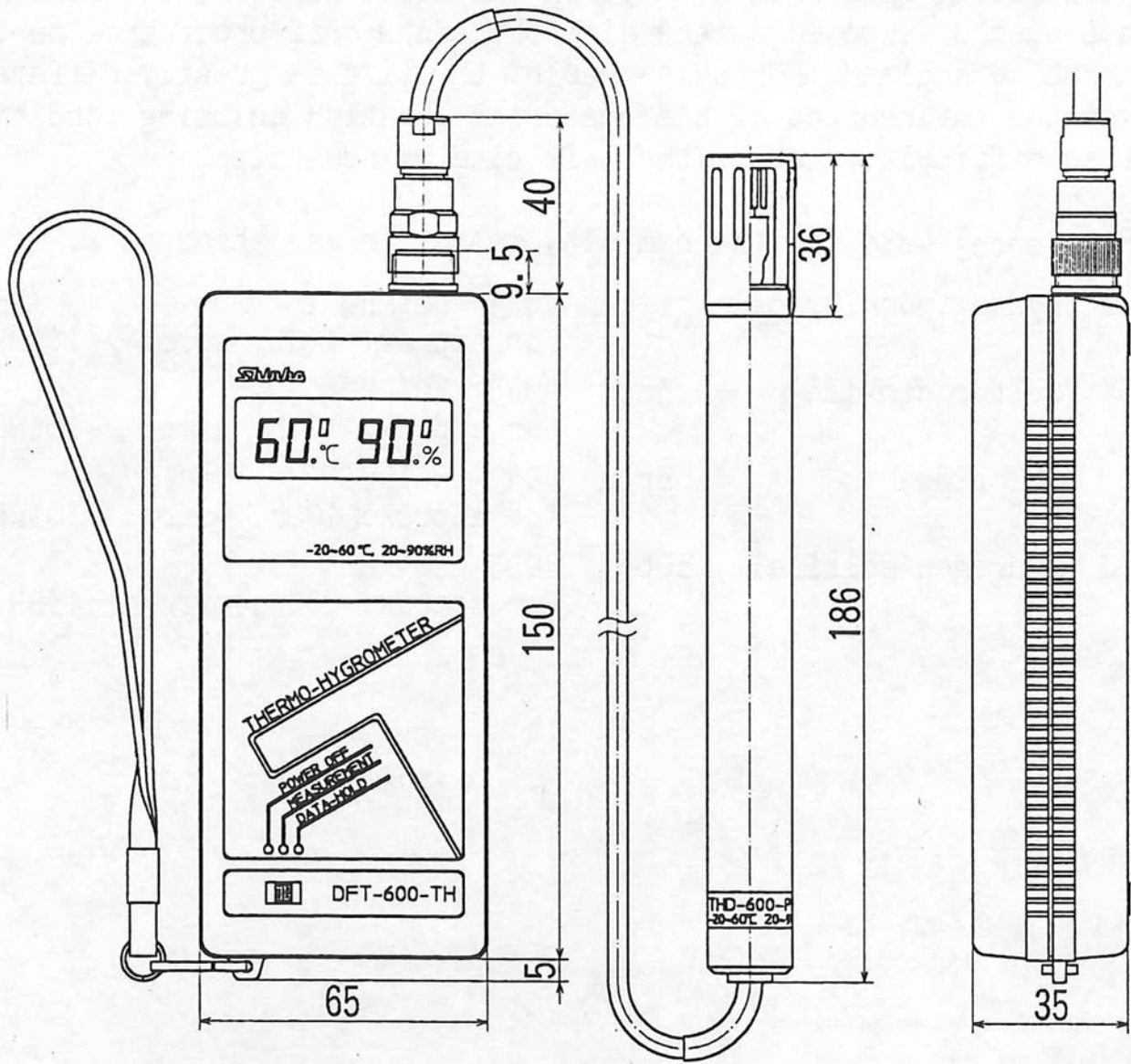

9. Specifications

9.1 DFT-600-TH

Name	: Hand held type Digital Hygrothermo Indicator
Model	: DFT-600-TH
Display	: Digital display using LCD LCD figure size, 10×5mm (H×W)
Indication	: Temperature and humidity simultaneous display
Unit display	: Temperature, °C or °F Humidity, % (°F is specified when ordering.)
Indicating accuracy	: Within ±1.0% ±1digit (at 25°C ±10°C)
Action system	: Dual slope (Sampling period: 0.5s)
Rated scale	: Temperature, -20.0 to 60.0°C (-4.0 to 99.9°F) Humidity, 0.0 to 99.9%RH
Resolution	: Temperature, 0.1°C (0.1°F) Humidity, 0.1%RH
Input	: Exclusive probe (Hygrothermo transmitter THD-600-P)
Supply voltage	: 6Vdc (R6P or LR6 ×4)
Battery life	: Approx. 2000h (Continuous indication at 25°C, 50%RH)
Ambient temperature	: 0 to 50°C (non-condensing)
Storage temperature	: -20 to 60°C (non-condensing)
Weight	: Approx. 250g
External dimension	: 63×152×35mm (W×H×D)
Case	: Material, ABS resin Color, Light gray

Action functions : Data hold

Setting the switch to DATA-HOLD, it holds the display value of temperature and humidity at that time. To cancel the hold, turn the switch to MEASUREMENT.

Battery alarm

When the battery voltage falls than the rated value, it blinks BAT mark on the display.

Accessories : Instruction manual 1 copy
Dry battery R6P 4 pieces

Applicable Hygro-thermo transmitter : THD-600-P (cord length, 1m)

9.2 THD-600-P

Name	: Hand grip type Hygrothermo Transmitter (Integral with Heat proof rubber cord with plug, cord length 1m)
Model	: THD-600-P
Measuring range	: Temperature, -20 to 60°C Humidity, 20 to 90%RH
Type of sensor	: Temperature, [TD-S] Platinum thin film RTD Humidity, [HD-S] Resistance change type
Accuracy	: Temperature, 0°C \pm 0.3°C 60°C \pm 0.6°C (JIS Pt100 B class) Humidity, Within \pm 5%RH (at 10 to 50°C)
Response characteristic	: Temperature, 35s Humidity, Within 2min (30 \leftrightarrow 80%RH)
Hysteresis	: Humidity, Within approx. 1%RH
Output	: Temperature, 3-wire system, 100 Ω at 0°C Humidity, 0 to 1Vdc (correspond to 0 to 100%RH)
Using temperature range	: Temperature, -20 to 60°C Humidity, 0 to 50°C
Storage environment	: -20 to 60°C, 5 to 90%RH (non-condensing, non-freezing)
Material	: Grip, Finished on Aluminum (Color, Black) Sensor cap, Polyacetal (Color, Black)
Weight	: Approx. 130g

. . . Inquiry . . .

For any inquiry of this indicator, after checking the following as to the indicator, please contact your shop where purchased, or our agency.

- | | |
|---------------------------|------------|
| | [Example] |
| • Model | DFT-600-TH |
| • Sensor probe | THD-600-P |
| • Temperature unit | °C |
| • Instrument number | No.□□□□□□ |

In addition to the above, let us know the details of malfunction, if any, and the operating conditions specifically on job site.

SHINKO TECHNOS CO., LTD.
OVERSEAS DIVISION

Reg Office : 2-48, 1-Chome, Ina, Minoo, Osaka, Japan
Mail Address: P.O.Box 17, Minoo, Osaka, Japan
Telephone : (0727)21-2781 & 2782

Telex: 5324127 (SHINKO J)
Cable: SHINKO MINOO JAPAN
FAX : (0727) 24-1760

No. D F T 6 3 E 1 45