

ON-SITE Type Conductivity Meter
FEB-102-ECH (High Concentration)
FEB-102-ECM (Low Concentration)
Instruction Manual

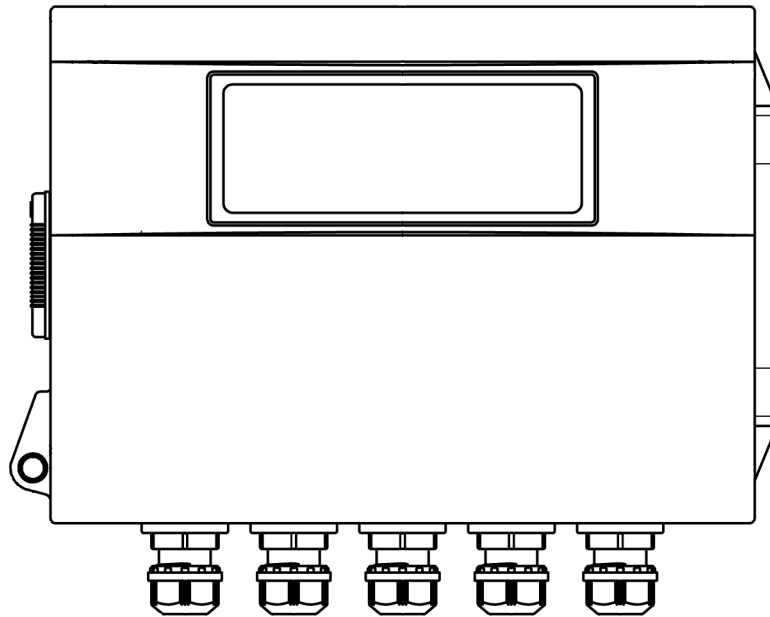

Shinko

Preface

Thank you for purchasing our FEB-102-ECH, ECM, ON-SITE Type Conductivity Meter.

This manual contains instructions for the mounting, functions, operations and notes when operating the FEB-102-ECH, ECM. To ensure safe and correct use, thoroughly read and understand this manual before using this instrument.

To prevent accidents arising from the misuse of this instrument, please ensure the operator receives this manual.

Caution

- This instrument should be used in accordance with the specifications described in the manual. If it is not used according to the specifications, it may malfunction or cause a fire.
- Be sure to follow all of the warnings, cautions and notices. If they are not observed, serious injury or malfunction may occur.
- The contents of this instruction manual are subject to change without notice.
- Care has been taken to ensure that the contents of this instruction manual are correct, but if there are any doubts, mistakes or questions, please inform our sales department.
- This instrument is designed to be wall-mounted. Measures must be taken to ensure that the operator cannot touch power terminals or other high voltage sections.
- Any unauthorized transfer or copying of this document, in part or in whole, is prohibited.
- Shinko Technos Co., Ltd. is not liable for any damage or secondary damage(s) incurred as a result of using this product, including any indirect damage.

Safety Precautions (Be sure to read these precautions before using our products.)

The safety precautions are classified into 2 categories: “Warning” and “Caution”.

Depending on the circumstances, procedures indicated by  Caution may result in serious consequences, so be sure to follow the directions for usage.

 **Warning** Procedures which may lead to dangerous conditions and cause death or serious injury, if not carried out properly.

 **Caution** Procedures which may lead to dangerous conditions and cause superficial to medium injury or physical damage or may degrade or damage the product, if not carried out properly.

Warning

- To prevent an electrical shock or fire, only Shinko or other qualified service personnel may handle the inner assembly.
- To prevent an electrical shock, fire or damage to the instrument, parts replacement may only be undertaken by Shinko or other qualified service personnel.

SAFETY PRECAUTIONS

- To ensure safe and correct use, thoroughly read and understand this manual before using this instrument.
- This instrument is intended to be used for industrial machinery, machine tools and measuring equipment. Verify correct usage after purpose-of-use consultation with our agency or main office. (Never use this instrument for medical purposes with which human lives are involved.)
- External protection devices such as protective equipment against excessive temperature rise, etc. must be installed, as malfunction of this product could result in serious damage to the system or injury to personnel. Also proper periodic maintenance is required.
- This instrument must be used under the conditions and environment described in this manual. Shinko Technos Co., Ltd. does not accept liability for any injury, loss of life or damage occurring due to the instrument being used under conditions not otherwise stated in this manual.

Caution with respect to Export Trade Control Ordinance

To avoid this instrument from being used as a component in, or as being utilized in the manufacture of weapons of mass destruction (i.e. military applications, military equipment, etc.), please investigate the end users and the final use of this instrument. In the case of resale, ensure that this instrument is not illegally exported.

PRECAUTIONS

1. Installation Precautions

Caution

This instrument is intended to be used under the following environmental conditions (IEC61010-1):

- Overvoltage category II, Pollution degree 2

Ensure the mounting location corresponds to the following conditions:

- A minimum of dust, and an absence of corrosive gases
- No flammable, explosive gases
- No mechanical vibrations or shocks
- No exposure to direct sunlight, an ambient temperature of -20 to 50°C (-4 to 122°F) that does not change rapidly, and no icing
- An ambient non-condensing humidity of 35 to 95 %RH
- No large capacity electromagnetic switches or cables through which large current is flowing.
- No water, oil or chemicals or where the vapors of these substances can come into direct contact with the unit
- The ambient temperature of the unit must be kept to under 50°C. Otherwise the life of electronic parts (especially electrolytic capacitors) of the unit will be shortened.

Note: Do not install this instrument on or near flammable material even though the case of this instrument is made of flame-resistant resin.

2. Wiring Precautions

Caution

- Use a ring-type solderless terminal with an insulation sleeve in which the M3 screw fits when wiring the FEB-102-ECH, ECM.
- Tighten the terminal screw using the specified torque. If excessive force is applied to the screw when tightening, the terminal screw may be damaged.
- This instrument does not have a built-in power switch, circuit breaker and fuse.
It is necessary to install a power switch, circuit breaker and fuse near the instrument.
(Recommended fuse: Time-lag fuse, rated voltage 250 V AC, rated current 2 A)
- Do not apply a commercial power source to the sensor which is connected to the input terminal nor allow the power source to come into contact with the sensor.
- Use the 4-electrode/2-electrode conductivity sensor in accordance with the sensor input specifications of the FEB-102- ECH, ECM.
- Keep the sensor cables and power cables separate, do not put them in the same cable clamp.

Note about the 4-electrode/2-electrode Conductivity Sensor Cable

The 4-electrode/2-electrode conductivity sensor cable is a highly-insulated (electrical) cable. Please handle it with utmost care as follows.

- Do not allow terminals and socket of the 4-electrode/2-electrode conductivity sensor cable to come in contact with moisture or oil of any kind. Likewise, ensure fingers are clean, otherwise the insulation will deteriorate, resulting in unstable indication.
Be sure to keep the cable dry and clean at all times.
If the cable is stained, clean it with alcohol, and dry it completely.
- For calibration or electrode checking/replacement, the 4-electrode/2-electrode conductivity sensor cable should be wired with sufficient length.
- Keep the 4-electrode/2-electrode conductivity sensor cable and junction cable away from electrical devices, such as motors or their power lines from which inductive interference emanates.

Connection

The 4-electrode conductivity sensor cable has the following terminals.

Symbol	Terminal
1	Conductivity sensor terminal
2	Conductivity sensor terminal
3	Conductivity sensor terminal
4	Conductivity sensor terminal
A, B, B	Temperature compensation electrode terminals (Pt100 or Pt1000)
E	Shield wire terminal

The 2-electrode conductivity sensor cable has the following terminals.

Symbol	Terminal
1	Conductivity sensor terminal
2	Conductivity sensor terminal
A, B, B	Temperature compensation electrode terminals (Pt100 or Pt1000)
E	Shield wire terminal

For the 4-electrode/2-electrode conductivity sensor with no temperature compensation, A, B, B cables are not available.

E cables are available depending on the sensor type.

3. Operation and Maintenance Precautions



Caution

- Do not touch live terminals. This may cause an electrical shock or problems in operation.
- Turn the power switch OFF when retightening the terminal or cleaning.
Working on or touching the terminal with the power switched ON may result in severe injury or death due to electrical shock.
- Use a soft, dry cloth when cleaning the instrument.
(Alcohol based substances may tarnish or deface the unit.)
- As the display section is vulnerable, do not strike or scratch it with a hard object or put pressure on it.

Contents

	Page
1. Model	
1.1 Model -----	8
1.2 How to Read the Model Label -----	8
2. Names and Functions of Sections	
2.1 Main Body -----	9
2.2 How to Open the Cover	
2.2.1 Open the Cover -----	9
2.2.2 Close the Cover -----	10
2.3 Display and Operation Panel -----	11
3. Mounting	
3.1 Site Selection -----	12
3.2 External Dimensions (Scale: mm) -----	12
3.3 Mounting -----	13
4. Wiring -----	14
4.1 Lead Wire Solderless Terminal -----	15
4.2 Terminal Arrangement	
4.2.1 FEB-102-ECH -----	16
4.2.2 FEB-102-ECM -----	16
5. Outline of Key Operation and Setting Groups	
5.1 Outline of Key Operation -----	17
5.2 Setting Groups -----	18
6. Setup	
6.1 Turn the Power Switch ON -----	19
6.2 Conductivity Input Group -----	20
6.3 Temperature Input Group -----	23
6.4 EVT1 Group -----	25
6.5 EVT2 Group -----	30
6.6 EVT3 Group -----	35
6.7 EVT4 Group -----	40
6.8 Communication Group -----	45
6.9 Transmission Output Group -----	46
6.10 Special Function Group -----	49
7. Calibration	
7.1 Conductivity Calibration Mode -----	50
7.2 Temperature Calibration Mode -----	52
7.3 Error Code during Temperature Calibration -----	52
7.4 Transmission Output 1 Adjustment Mode -----	53
7.5 Transmission Output 2 Adjustment Mode -----	54
8. Measurement	
8.1 Starting Measurement -----	55
8.2 Error Code during Measurement -----	55
8.3 Setting EVT1, EVT2, EVT3, EVT4 Values -----	56
8.4 EVT1, EVT2, EVT3, EVT4 Outputs -----	57
8.5 Error Output -----	58

8.6 Fail Output -----	58
8.7 Conductivity Input Error Alarm -----	58
8.8 Cycle Automatic Variable Function -----	59
8.9 Transmission Output -----	60
9. Specifications	
9.1 Standard Specifications -----	61
9.2 Optional Specifications -----	68
10. Troubleshooting	
10.1 Indication -----	69
10.2 Key Operation -----	70
11 Character Tables	
11.1 Setting Groups -----	71
11.2 Temperature Calibration Mode -----	71
11.3 Conductivity Calibration Mode -----	71
11.4 Transmission Output 1 Adjustment Mode -----	72
11.5 Transmission Output 2 Adjustment Mode -----	72
11.6 Simple Setting Mode -----	73
11.7 Conductivity Input Group -----	73
11.8 Temperature Input Group -----	75
11.9 EVT1 Group -----	76
11.10 EVT2 Group -----	77
11.11 EVT3 Group -----	79
11.12 EVT4 Group -----	80
11.13 Communication Group -----	82
11.14 Transmission Output Group -----	82
11.15 Special Function Group -----	83
12. Key Operation Flowchart -----	84

1. Model

1.1 Model

F E B - 1 0	2-	EC	<input type="checkbox"/>	, <input type="checkbox"/> <input type="checkbox"/> <input type="checkbox"/>	
Input Points	2				2 points
Input		EC			4-electrode conductivity sensor: (Temperature element: Pt100 or Pt1000) 2-electrode conductivity sensor: (Temperature element: Pt100 or Pt1000)
Concentration		H			High concentration
		M			Low concentration
Supply Voltage					100 to 240 V AC
Option		C5			Serial communication RS-485 (*1)
		EVT3			EVT3 output (Contact output 3) (*2)
		EVT4			EVT3, EVT4 output (Contact outputs 3, 4) (*1)

(*1) If C5 or EVT4 option is ordered, Transmission output 1 and 2 are not available.

(*2) If EVT3 is ordered, Transmission output 1 is not available.

1.2 How to Read the Model Label

The model label is attached on the inside of the cover.

Model label differs depending on the model.

FEB-102-ECH:

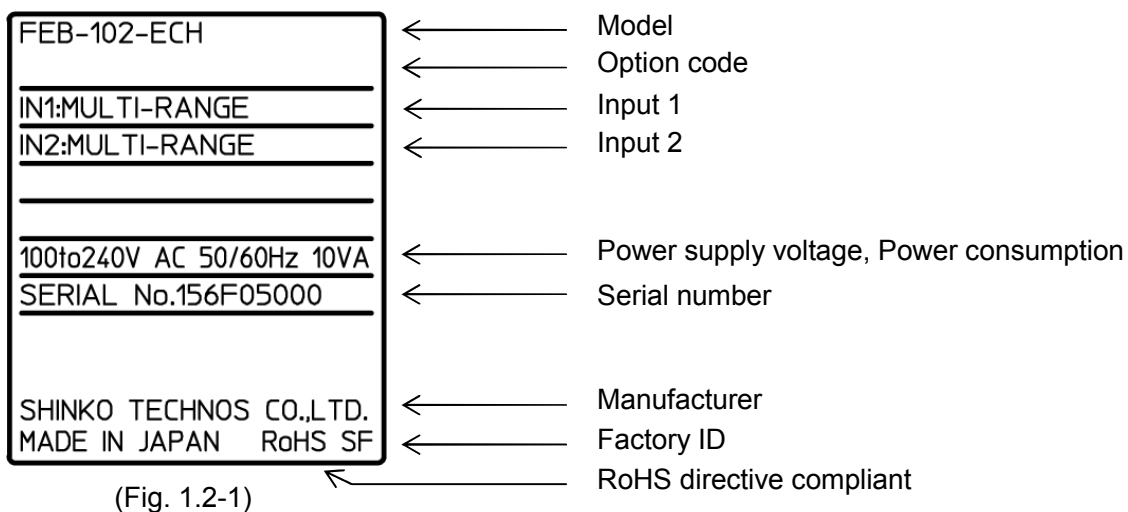

(Fig. 1.2-1)

FEB-102-ECM:

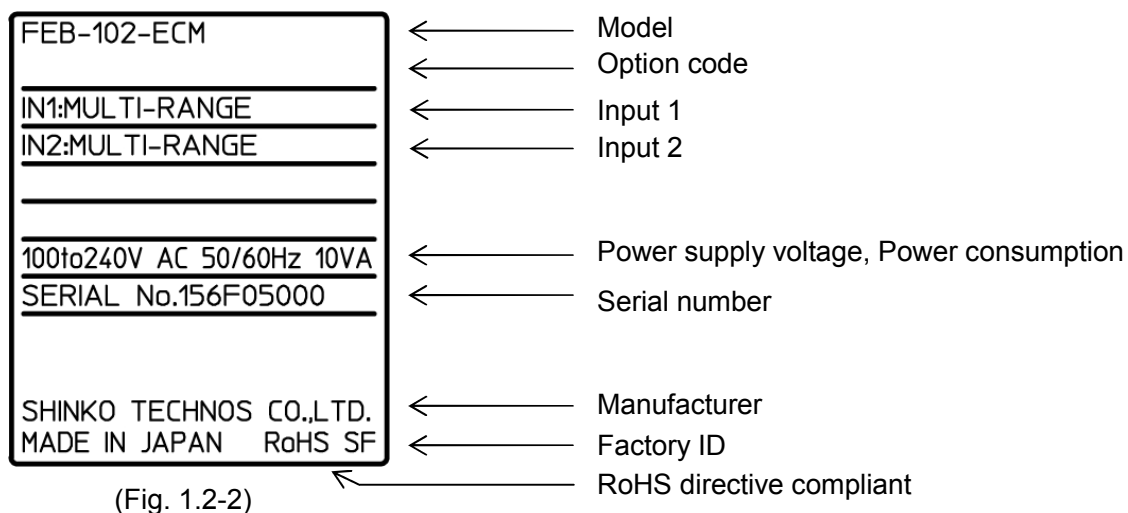

(Fig. 1.2-2)

2. Names and Functions of Sections

2.1 Main Body

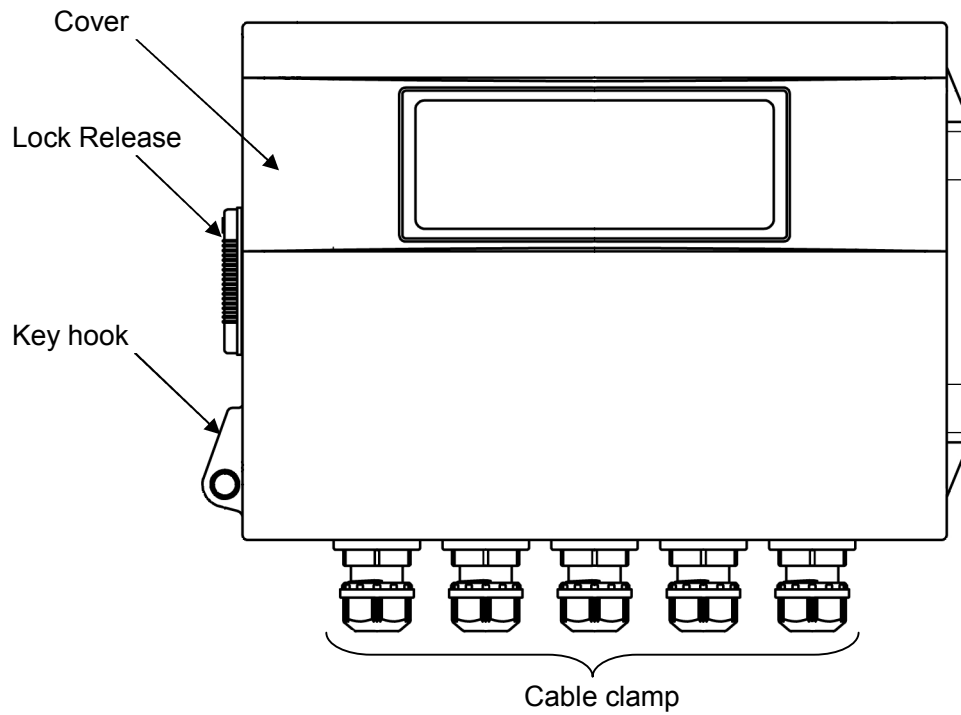

(Fig. 2.1-1)

2.2 How to Open/Close the Cover

2.2.1 Open the Cover

(1) Push the Lock Release up to unlock it.

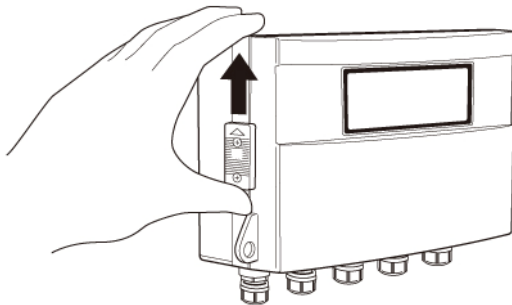

(Fig. 2.2.1-1)

(2) Pull the cover toward you to open it.

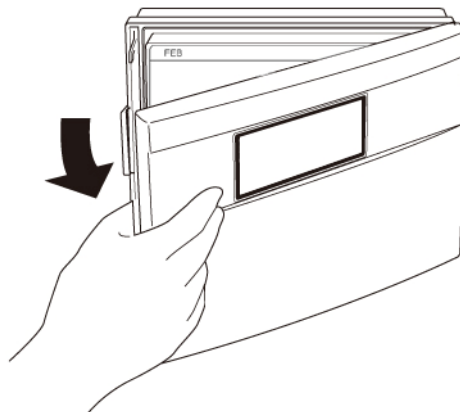

(Fig. 2.2.1-2)

2.2.2 Close the Cover.

(1) Close the cover tightly by pushing firmly until no gap remains between the body and cover.

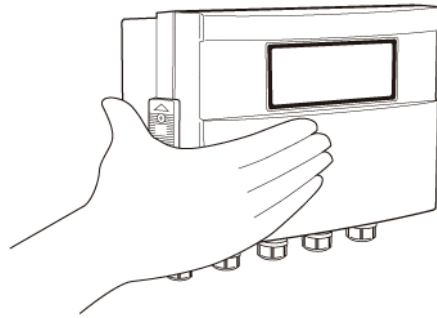

(Fig. 2.2.2-1)

(2) Lock the unit by pulling the Lock Release down completely.



Caution

- Confirm that the Lock Release is securely locked.
If it is not locked, Drip-proof/Dust-proof specification (IP65) may be compromised.

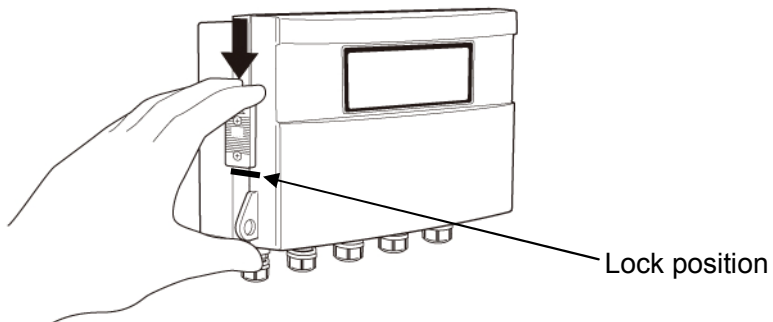

(Fig. 2.2.2-2)

2.3 Display and Operation Panel

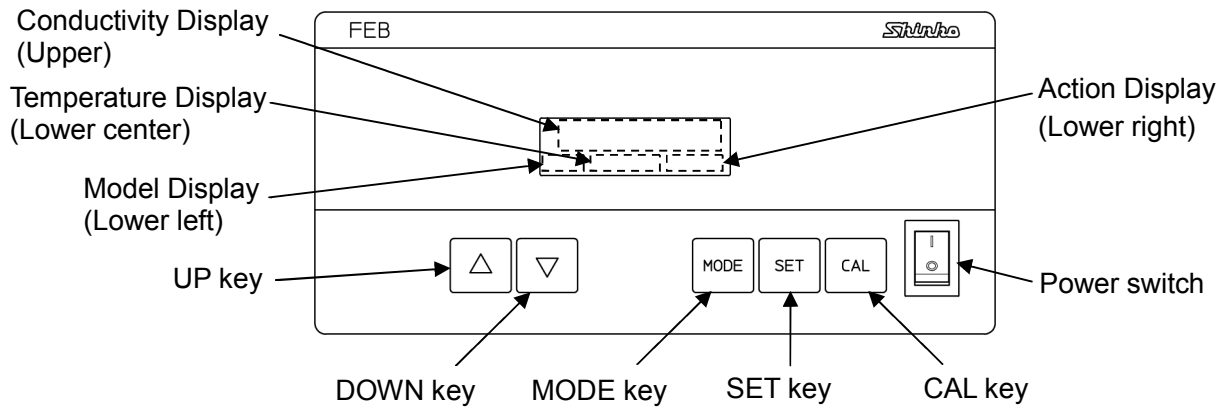

(Fig. 2.3-1)

Conductivity Display (Upper), Temperature Display (Lower center):

In Conductivity/Temperature Display Mode, the Conductivity Display indicates conductivity, and the Temperature Display indicates temperature.

In Setting mode or Calibration mode, the Conductivity Display indicates a setting item or calibration item, and the Temperature Display indicates a set value or calibration value.

Indication differs depending on the selection in [Display selection] or [Temperature Display when no temperature compensation (p.49)].

Model Display (Lower left)

Indicates the model:

[ECH]: Indicated for the FEB-102-ECH.

[ECM]: Indicated for the FEB-102-ECM.

Action Display (Lower right)

EV1: Indicated when EVT1 output (Contact output 1) is ON.

EV2: Indicated when EVT2 output (Contact output 2) is ON.

EV3: Indicated when EVT3 output (Contact output 3) is ON.

(When EVT3 option or EVT4 option is ordered)

EV4: Indicated when EVT4 output (Contact output 4) is ON (When EVT4 option is ordered).

T/R: Indicated while in Serial communication TX output (transmitting) (When C5 option is ordered).

Keys



 UP key: Increases the numeric value.

 DOWN key: Decreases the numeric value, or selects a group.

 MODE key: Moves to the group selection, or returns to Conductivity/Temperature Display Mode from a setting item.

 SET key: Switches the setting modes, and registers the set value.

 CAL key: Moves to the Conductivity Calibration Mode.

By pressing the  and  key together, the unit reverts to Temperature Calibration Mode.

Switch

Power switch: Turns the power to the instrument ON/OFF.

⏏ : Turns ON.

⏻ : Turns OFF.

3.3 Mounting

- (1) Fix the mounting bracket to the wall.

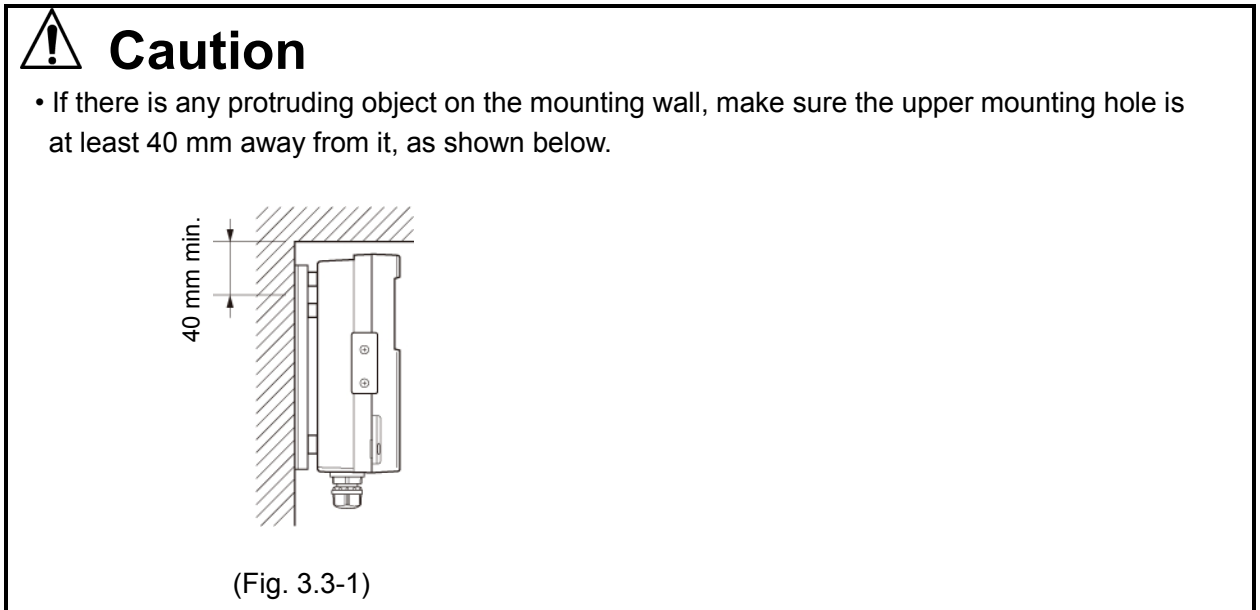

- (2) Hook this instrument on the stud of the mounting bracket.
- (3) Open the cover and the terminal cover, and mount the instrument with the provided screws.

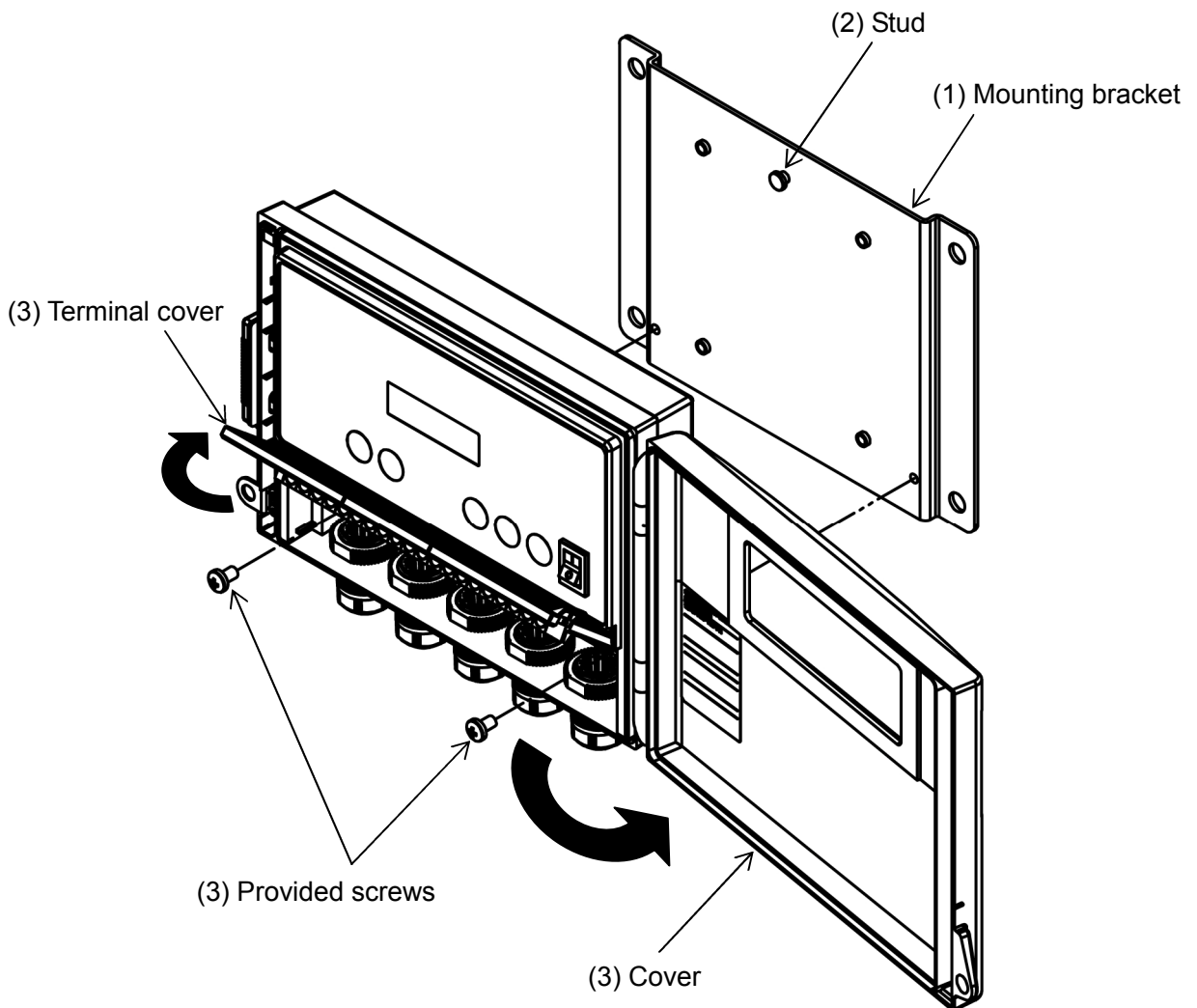

(Fig. 3.3-2)

4. Wiring



Warning

Turn the power supply to the instrument OFF before wiring or checking.

Working on or touching the terminal with the power switched on may result in severe injury or death due to electrical shock.



Caution

- Use a ring-type solderless terminal with an insulation sleeve in which the M3 screw fits when wiring the unit.
- Tighten the terminal screw using the specified torque. If excessive force is applied to the screw when tightening, the terminal screw may be damaged.
- This instrument does not have a built-in power switch, circuit breaker and fuse. It is necessary to install a power switch, circuit breaker and fuse near the instrument. (Recommended fuse: Time-lag fuse, rated voltage 250 V AC, rated current 2 A)
- Do not apply a commercial power source to the sensor which is connected to the input terminals nor allow the power source to come into contact with the sensor.
- Use the 4-electrode/2-electrode conductivity sensor in accordance with the sensor input specifications of this unit.
- Keep the sensor cables and power cables in separate groups, do not put them in the same cable clamp.

Note about the 4-Electrode/2-Electrode Conductivity Sensor Cable

The 4-electrode/2-electrode conductivity sensor cable is a highly-insulated (electrical) cable. Please handle it with utmost care as follows.

- Do not allow terminals and socket of the 4-electrode/2-electrode conductivity sensor cable to come in contact with moisture or oil of any kind. Likewise, ensure fingers are clean, otherwise the insulation will deteriorate, resulting in unstable indication. Be sure to keep the cable dry and clean at all times. If the cable is stained, clean it with alcohol, and dry it completely.
- For calibration or electrode checking/replacement, the 4-electrode/2-electrode conductivity sensor cable should be wired with sufficient length.
- Keep the 4-electrode/2-electrode conductivity sensor cable and junction cable away from electrical devices, such as motors or their power lines from which inductive interference emanates.

Connection

The 4-electrode conductivity sensor cable has the following terminals.

Symbol	Terminal
1	Conductivity sensor terminal
2	Conductivity sensor terminal
3	Conductivity sensor terminal
4	Conductivity sensor terminal
A, B, B	Temperature compensation electrode terminals (Pt100 or Pt1000)
E	Shield wire terminal

The 2-electrode conductivity sensor cable has the following terminals.

Symbol	Terminal
1	Conductivity sensor terminal
2	Conductivity sensor terminal
A, B, B	Temperature compensation electrode terminals (Pt100 or Pt1000)
E	Shield wire terminal

For the 4-electrode/2-electrode conductivity sensor with no temperature compensation, A, B, B cables are not available.

E cables are available depending on the sensor type.

4.1 Lead Wire Solderless Terminal

Use a ring-type solderless terminal with an insulation sleeve in which an M3 screw fits as follows.

The tightening torque should be 0.5 N·m.

Solderless Terminal	Manufacturer	Model
Ring-type	Nichifu Terminal Industries CO.,LTD.	TMEV1.25-3
	Japan Solderless Terminal MFG CO.,LTD.	V1.25-3

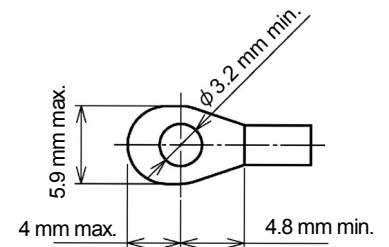

(Fig. 4.1-1)

4.2 Terminal Arrangement

Terminal arrangement differs depending on the model.

4.2.1 FEB-102-ECH

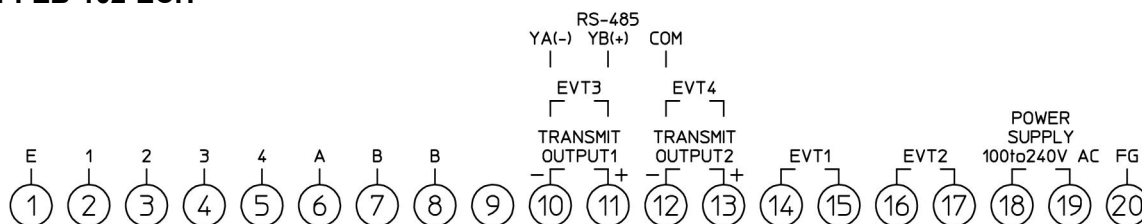

(Fig. 4.2.1-1)

- E: 4-electrode conductivity sensor, Shield wire terminal (①)
- 1, 2, 3, 4: 4-electrode conductivity sensor, Sensor terminals (② – ③ – ④ – ⑤)
- A, B: Temperature element: Pt100 (2-wire), Pt1000 (2-wire) Temperature compensation sensor terminals (⑥ – ⑦)
- A, B, B: Temperature element: Pt100 (3-wire) Temperature compensation sensor terminals (⑥ – ⑦ – ⑧)
- TRANSMIT OUTPUT1: Transmission output 1 terminals (⑩ – ⑪)
(Not available if C5, EVT3 or EVT4 option is ordered)
- TRANSMIT OUTPUT2: Transmission output 2 terminals (⑫ – ⑬)
(Not available if C5 or EVT4 option is ordered.)
- EVT1: EVT1 output (Contact output 1) terminals (⑭ – ⑮)
- EVT2: EVT2 output (Contact output 2) terminals (⑯ – ⑰)
- EVT3: EVT3 output (Contact output 3) terminals (⑩ – ⑪) (When EVT3 or EVT4 option is ordered)
- EVT4: EVT4 output (Contact output 4) terminals (⑩ – ⑪) (When EVT4 option is ordered)
- RS-485: Serial communication terminals (⑩ – ⑪ – ⑫) (When C5 option is ordered)
- POWER SUPPLY: Power terminals (⑱ – ⑲)
- FG: Ground terminals (⑳)

4.2.2 FEB-102-ECM

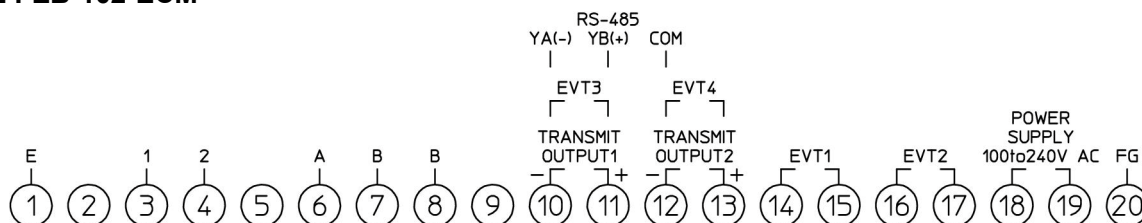

(Fig. 4.2.2-1)

- E: 2-electrode conductivity sensor Shield wire terminals (①)
- 1, 2: 2-electrode conductivity sensor Sensor terminals (③ – ④)
- A, B: Temperature element: Pt100 (2-wire), Pt1000 (2-wire) Temperature compensation sensor terminals (⑥ – ⑦)
- A, B, B: Temperature element: Pt100 (3-wire) Temperature compensation sensor terminals (⑥ – ⑦ – ⑧)
- TRANSMIT OUTPUT1: Transmission output 1 terminals (⑩ – ⑪)
(Not available if C5, EVT3 or EVT4 option is ordered)
- TRANSMIT OUTPUT2: Transmission output 2 terminals (⑫ – ⑬)
(Not available if C5 or EVT4 option is ordered.)
- EVT1: EVT1 output (Contact output 1) terminals (⑭ – ⑮)
- EVT2: EVT2 output (Contact output 2) terminals (⑯ – ⑰)
- EVT3: EVT3 output (Contact output 3) terminals (⑩ – ⑪) (When EVT3 or EVT4 option is ordered)
- EVT4: EVT4 output (Contact output 4) terminals (⑩ – ⑪) (When EVT4 option is ordered)
- RS-485: Serial communication terminals (⑩ – ⑪ – ⑫) (When C5 option is ordered)
- POWER SUPPLY: Power terminals (⑱ – ⑲)
- FG: Ground terminals (⑳)

5. Outline of Key Operation and Setting Groups

5.1 Outline of Key Operation

There are Simple Setting Mode, and Group Selection Mode into which setting items are divided.

To enter Simple Setting mode, press the  key in Conductivity/Temperature Display Mode.

To enter Group Selection mode, press the  key in Conductivity/Temperature Display Mode.

Select a group with the  key, then press the  key. The unit will move to the each setting item.

Make settings with the  key or  key, and register settings with the  key.

By pressing the  key in Simple Setting Mode, Group Selection Mode or at any setting item, the unit reverts to Conductivity/Temperature Display Mode.

5.2 Setting Groups

Abbreviations: Adjust: Adjustment
Temp.: Temperature

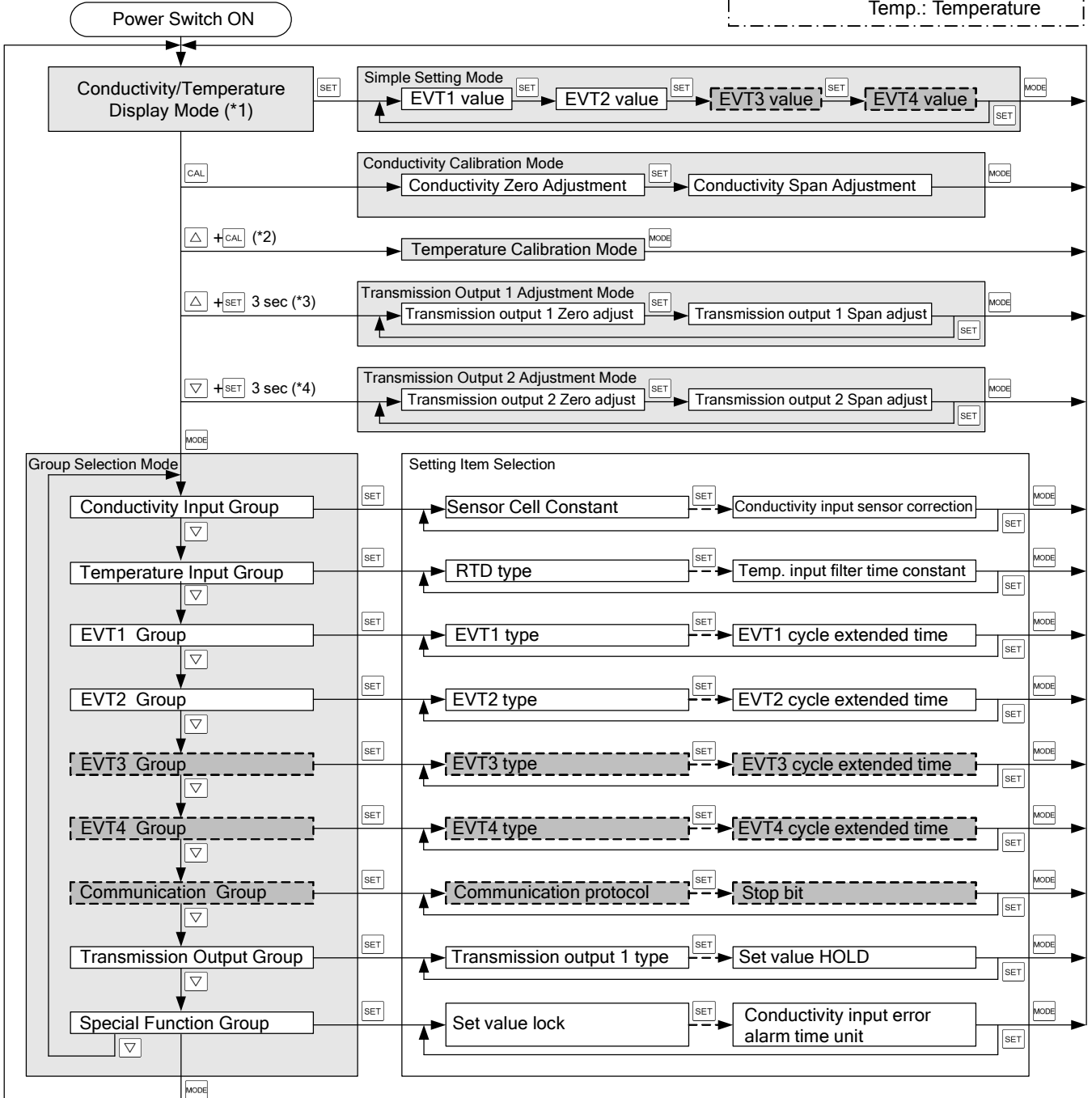

About Each Mode and Setting Items

(*1) In Conductivity/Temperature Display Mode, indicates items selected in [Display selection] and [Temperature display when no temperature compensation (p.49)].

(*2) If **OFF** (No temperature compensation) is selected in [Temperature compensation method (p.23)], the unit will not proceed to Temperature Calibration mode.

(*3) If C5, EVT3 or EVT4 option is ordered, the unit will not move to Transmission Output 1 Adjustment Mode.

(*4) If C5 or EVT4 option is ordered, the unit will not move to Transmission Output 2 Adjustment Mode.

[Dashed Box]: Available only when option is ordered.

Key Operation

- **[SET]**, **[CAL]**, **[MODE]**, **[▽]**: If **[SET]**, **[CAL]**, **[MODE]** or **[▽]** key is pressed, the unit will proceed to the next setting item, illustrated by an arrow.
- **[SET]**: Press the **[SET]** key until the desired setting mode appears.
- **[Δ] + [CAL]**: Press the **[Δ]** and **[CAL]** keys (in that order) together. The unit will enter Temperature Calibration Mode.
- **[Δ] + [SET] (3 sec)**: Press and hold the **[Δ]** and **[SET]** keys (in that order) together for 3 seconds. The unit will enter Transmission Output 1 Adjustment Mode.
- **[▽] + [SET] (3 sec)**: Press and hold the **[▽]** and **[SET]** keys (in that order) together for 3 seconds. The unit will enter Transmission Output 2 Adjustment Mode.
- If the **[MODE]** key is pressed at each setting item, the unit will revert to Conductivity/Temperature Display Mode.

6. Setup

Setup should be done before using this instrument according to the user's conditions:

Setting Conductivity input, Temperature input, EVT1 to EVT4 types, Communication, Transmission output, Display setting, etc.

Setup is performed in the following groups.

- (1) Conductivity input group
- (2) Temperature input group
- (3) EVT1 group
- (4) EVT2 group
- (5) EVT3 group (EVT3, EVT4 options)
- (6) EVT4 group (EVT4 option)
- (7) Communication group (C5 option)
- (8) Transmission output group
- (9) Special function group

If the user's specification is the same as the factory default value of this instrument, or if user's instrument has already been installed in a system after setup was complete, initial setup is not necessary.

Proceed to Section '7. Calibration' (p.50).

6.1 Turn the Power Switch ON.

For approx. 4 seconds after the power switch is turned ON, the input type is indicated in the Conductivity Display and Temperature Display.

FEB-102-ECH

Conductivity Display	Item Selected in [Measurement Unit (p.20)]	Temperature Display
CONV <input type="checkbox"/>	Conductivity (mS/cm)	PT100 <input type="checkbox"/> or PT1000
SI <input type="checkbox"/>	Conductivity (S/m, mS/m)	
SEA <input type="checkbox"/>	Seawater salinity (%)	
SALT <input type="checkbox"/>	NaCl salinity (%)	
TDS <input type="checkbox"/>	TDS conversion (g/L)	

FEB-102-ECM

Conductivity Display	Item Selected in [Measurement Unit (p.20)]	Temperature Display
CONV <input type="checkbox"/>	Conductivity (μ S/cm)	PT100 <input type="checkbox"/> or PT1000
SI <input type="checkbox"/>	Conductivity (mS/m)	
TDS <input type="checkbox"/>	TDS conversion (mg/L)	

After that, measurement starts, indicating items selected in [Display selection] and [Temperature Display when no temperature compensation (p.49)].

This status is called Conductivity/Temperature Display Mode.

6.2 Conductivity Input Group

To enter the Conductivity Input Group, follow the procedure below.

① **G.EC** Press the **MODE** key in Conductivity/Temperature Display Mode.

② **CELL** Press the **SET** key.

The unit will proceed to the Conductivity Input Group, and 'Sensor cell constant' will appear.

Character	Setting Item, Function, Setting Range	Factory Default
CELL 1.0	Sensor cell constant <ul style="list-style-type: none"> Selects sensor cell constant. If the cell constant is changed, the Conductivity Zero adjustment value, Span adjustment value, and Cell constant correction value are cleared. Set the Cell constant correction value again, and re-calibrate the Conductivity Zero adjustment and Span adjustment values. Selection items differ depending on the model. FEB-102-ECH: 1.0: 1.0/cm 10.0: 10.0/cm FEB-102-ECM: 0.01: 0.01/cm 0.1: 0.1/cm 1.0: 1.0/cm	FEB-102-ECH : 1.0/cm FEB-102-ECM : 0.01/cm
COEF 1.000	Cell constant correction value <ul style="list-style-type: none"> Sets sensor cell constant correction value. COEF and conductivity are displayed alternately. Setting range: 0.001 to 5.000 	1.000
UNIT CONV	Measurement unit <ul style="list-style-type: none"> Selects the conductivity unit. If the conductivity unit is changed, the Conductivity Zero adjustment value, Span adjustment value and Cell constant correction value will be cleared. Set the Cell constant correction value again, and re-calibrate the Conductivity Zero adjustment and Span adjustment values. If the following is changed, the Conductivity Span adjustment value and Cell constant correction value will not be cleared. Re-calibrate <i>only</i> the Conductivity Zero adjustment value. Changing from Conductivity (mS/cm, S/m) to Seawater salinity (%) or NaCl salinity (%). Changing from Seawater salinity (%) or NaCl salinity (%) to Conductivity (mS/cm, S/m). Changing from Seawater salinity (%) to NaCl salinity (%). Selection items differ depending on the model. FEB-102-ECH: CONV : Conductivity (mS/cm) SI : Conductivity (S/m, mS/m) SEA : Seawater salinity (%) SALT : NaCl salinity (%) TDS : TDS conversion (g/L) FEB-102-ECM: CONV : Conductivity (μ S/cm) SI : Conductivity (mS/m) TDS : TDS conversion (mg/L)	FEB-102-ECH: Conductivity (mS/cm) FEB-102-ECM: Conductivity (μ S/cm)

Character	Setting Item, Function, Setting Range	Factory Default																																																																																																				
MRNG 20.00	Measurement range <ul style="list-style-type: none"> Selects the measurement range of conductivity. If the measurement range is changed, the Conductivity Zero adjustment value, Span adjustment value and Cell constant correction value are cleared. Set the Cell constant correction value again, and re-calibrate the Conductivity Zero adjustment and Span adjustment values. <ul style="list-style-type: none"> Selection items differ depending on the model. FEB-102-ECH: Selection items differ depending on [Sensor cell constant] and [Measurement unit]. When sensor cell constant 1.0/cm is selected: <table border="1"> <thead> <tr> <th>Measurement Unit</th> <th>Selection Item</th> <th>Measurement Range</th> </tr> </thead> <tbody> <tr> <td rowspan="4">Conductivity (mS/cm)</td> <td>20.00</td> <td>0.00 to 20.00 mS/cm</td> </tr> <tr> <td>200.0</td> <td>0.0 to 200.0 mS/cm</td> </tr> <tr> <td>500.0</td> <td>0.0 to 500.0 mS/cm</td> </tr> <tr> <td>500</td> <td>0 to 500 mS/cm</td> </tr> <tr> <td rowspan="5">Conductivity (S/m, mS/m)</td> <td>2.000</td> <td>0.000 to 2.000 S/m</td> </tr> <tr> <td>20.00</td> <td>0.00 to 20.00 S/m</td> </tr> <tr> <td>50.00</td> <td>0.00 to 50.00 S/m</td> </tr> <tr> <td>50.0</td> <td>0.0 to 50.0 S/m</td> </tr> <tr> <td>2000</td> <td>0 to 2000 mS/m</td> </tr> <tr> <td>Seawater salinity (%)</td> <td>4.00</td> <td>0.00 to 4.00 %</td> </tr> <tr> <td>NaCl salinity (%)</td> <td>20.00</td> <td>0.00 to 20.00 %</td> </tr> <tr> <td rowspan="3">TDS conversion (g/L)</td> <td>20.0</td> <td>0.0 to 20.0 g/L</td> </tr> <tr> <td>200</td> <td>0 to 200 g/L</td> </tr> <tr> <td>500</td> <td>0 to 500 g/L</td> </tr> </tbody> </table> When sensor cell constant 10.0/cm is selected: <table border="1"> <thead> <tr> <th>Measurement Unit</th> <th>Selection Item</th> <th>Measurement Range</th> </tr> </thead> <tbody> <tr> <td rowspan="3">Conductivity (mS/cm)</td> <td>200.0</td> <td>0.0 to 200.0 mS/cm</td> </tr> <tr> <td>500.0</td> <td>0.0 to 500.0 mS/cm</td> </tr> <tr> <td>2000</td> <td>0 to 2000 mS/cm</td> </tr> <tr> <td rowspan="3">Conductivity (S/m)</td> <td>20.00</td> <td>0.00 to 20.00 S/m</td> </tr> <tr> <td>50.00</td> <td>0.00 to 50.00 S/m</td> </tr> <tr> <td>200.0</td> <td>0.0 to 200.0 S/m</td> </tr> <tr> <td>Seawater salinity (%)</td> <td>4.00</td> <td>0.00 to 4.00 %</td> </tr> <tr> <td>NaCl salinity (%)</td> <td>20.00</td> <td>0.00 to 20.00 %</td> </tr> <tr> <td rowspan="3">TDS conversion (g/L)</td> <td>200</td> <td>0 to 200 g/L</td> </tr> <tr> <td>500</td> <td>0 to 500 g/L</td> </tr> <tr> <td>2000</td> <td>0 to 2000 g/L</td> </tr> </tbody> </table> FEB-102-ECM: Measurement range is fixed by selecting Sensor cell constant and Measurement unit. <table border="1"> <thead> <tr> <th>Measurement Unit</th> <th>Sensor Cell Constant</th> <th>Item</th> <th>Measurement Range</th> </tr> </thead> <tbody> <tr> <td rowspan="3">Conductivity (μS/cm)</td> <td>0.01/cm</td> <td>20.00</td> <td>0.00 to 20.00 μS/cm</td> </tr> <tr> <td>0.1/cm</td> <td>200.0</td> <td>0.0 to 200.0 μS/cm</td> </tr> <tr> <td>1.0/cm</td> <td>2000</td> <td>0 to 2000 μS/cm</td> </tr> <tr> <td rowspan="3">Conductivity (mS/m)</td> <td>0.01/cm</td> <td>2.000</td> <td>0.000 to 2.000 mS/m</td> </tr> <tr> <td>0.1/cm</td> <td>20.00</td> <td>0.00 to 20.00 mS/m</td> </tr> <tr> <td>1.0/cm</td> <td>200.0</td> <td>0.0 to 200.0 mS/m</td> </tr> <tr> <td rowspan="3">TDS conversion (mg/L)</td> <td>0.01/cm</td> <td>20.0</td> <td>0.0 to 20.0 mg/L</td> </tr> <tr> <td>0.1/cm</td> <td>200</td> <td>0 to 200 mg/L</td> </tr> <tr> <td>1.0/cm</td> <td>2000</td> <td>0 to 2000 mg/L</td> </tr> </tbody> </table>	Measurement Unit	Selection Item	Measurement Range	Conductivity (mS/cm)	20.00	0.00 to 20.00 mS/cm	200.0	0.0 to 200.0 mS/cm	500.0	0.0 to 500.0 mS/cm	500	0 to 500 mS/cm	Conductivity (S/m, mS/m)	2.000	0.000 to 2.000 S/m	20.00	0.00 to 20.00 S/m	50.00	0.00 to 50.00 S/m	50.0	0.0 to 50.0 S/m	2000	0 to 2000 mS/m	Seawater salinity (%)	4.00	0.00 to 4.00 %	NaCl salinity (%)	20.00	0.00 to 20.00 %	TDS conversion (g/L)	20.0	0.0 to 20.0 g/L	200	0 to 200 g/L	500	0 to 500 g/L	Measurement Unit	Selection Item	Measurement Range	Conductivity (mS/cm)	200.0	0.0 to 200.0 mS/cm	500.0	0.0 to 500.0 mS/cm	2000	0 to 2000 mS/cm	Conductivity (S/m)	20.00	0.00 to 20.00 S/m	50.00	0.00 to 50.00 S/m	200.0	0.0 to 200.0 S/m	Seawater salinity (%)	4.00	0.00 to 4.00 %	NaCl salinity (%)	20.00	0.00 to 20.00 %	TDS conversion (g/L)	200	0 to 200 g/L	500	0 to 500 g/L	2000	0 to 2000 g/L	Measurement Unit	Sensor Cell Constant	Item	Measurement Range	Conductivity (μ S/cm)	0.01/cm	20.00	0.00 to 20.00 μ S/cm	0.1/cm	200.0	0.0 to 200.0 μ S/cm	1.0/cm	2000	0 to 2000 μ S/cm	Conductivity (mS/m)	0.01/cm	2.000	0.000 to 2.000 mS/m	0.1/cm	20.00	0.00 to 20.00 mS/m	1.0/cm	200.0	0.0 to 200.0 mS/m	TDS conversion (mg/L)	0.01/cm	20.0	0.0 to 20.0 mg/L	0.1/cm	200	0 to 200 mg/L	1.0/cm	2000	0 to 2000 mg/L	FEB-102-ECH: 0.00 to 20.00 mS/cm FEB-102-ECM: 0.00 to 20.00 μ S/cm (Fixed)
Measurement Unit	Selection Item	Measurement Range																																																																																																				
Conductivity (mS/cm)	20.00	0.00 to 20.00 mS/cm																																																																																																				
	200.0	0.0 to 200.0 mS/cm																																																																																																				
	500.0	0.0 to 500.0 mS/cm																																																																																																				
	500	0 to 500 mS/cm																																																																																																				
Conductivity (S/m, mS/m)	2.000	0.000 to 2.000 S/m																																																																																																				
	20.00	0.00 to 20.00 S/m																																																																																																				
	50.00	0.00 to 50.00 S/m																																																																																																				
	50.0	0.0 to 50.0 S/m																																																																																																				
	2000	0 to 2000 mS/m																																																																																																				
Seawater salinity (%)	4.00	0.00 to 4.00 %																																																																																																				
NaCl salinity (%)	20.00	0.00 to 20.00 %																																																																																																				
TDS conversion (g/L)	20.0	0.0 to 20.0 g/L																																																																																																				
	200	0 to 200 g/L																																																																																																				
	500	0 to 500 g/L																																																																																																				
Measurement Unit	Selection Item	Measurement Range																																																																																																				
Conductivity (mS/cm)	200.0	0.0 to 200.0 mS/cm																																																																																																				
	500.0	0.0 to 500.0 mS/cm																																																																																																				
	2000	0 to 2000 mS/cm																																																																																																				
Conductivity (S/m)	20.00	0.00 to 20.00 S/m																																																																																																				
	50.00	0.00 to 50.00 S/m																																																																																																				
	200.0	0.0 to 200.0 S/m																																																																																																				
Seawater salinity (%)	4.00	0.00 to 4.00 %																																																																																																				
NaCl salinity (%)	20.00	0.00 to 20.00 %																																																																																																				
TDS conversion (g/L)	200	0 to 200 g/L																																																																																																				
	500	0 to 500 g/L																																																																																																				
	2000	0 to 2000 g/L																																																																																																				
Measurement Unit	Sensor Cell Constant	Item	Measurement Range																																																																																																			
Conductivity (μ S/cm)	0.01/cm	20.00	0.00 to 20.00 μ S/cm																																																																																																			
	0.1/cm	200.0	0.0 to 200.0 μ S/cm																																																																																																			
	1.0/cm	2000	0 to 2000 μ S/cm																																																																																																			
Conductivity (mS/m)	0.01/cm	2.000	0.000 to 2.000 mS/m																																																																																																			
	0.1/cm	20.00	0.00 to 20.00 mS/m																																																																																																			
	1.0/cm	200.0	0.0 to 200.0 mS/m																																																																																																			
TDS conversion (mg/L)	0.01/cm	20.0	0.0 to 20.0 mg/L																																																																																																			
	0.1/cm	200	0 to 200 mg/L																																																																																																			
	1.0/cm	2000	0 to 2000 mg/L																																																																																																			

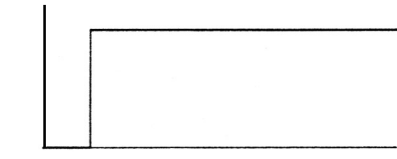
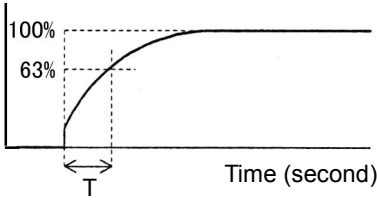
Character	Setting Item, Function, Setting Range	Factory Default
TDSK 0.50	TDS conversion factor • Sets TDS conversion factor. Available only when TDS [TDS conversion (g/L) or (mg/L)] is selected in [Measurement unit (p.20)]. • Setting range: 0.30 to 1.00	0.50
FIT1 0.0	Conductivity input filter time constant • Sets Conductivity input filter time constant. Even when the Conductivity measurement value changes as shown in (Fig. 6.2-1), if the filter time constant “T” is set, the Conductivity measurement value changes so that it can reach 63% of the Conductivity measurement value in T seconds as shown in (Fig. 6.2-2). If the value is set too large, it adversely affects EVT action due to the delay of response. (e.g.) If the lowest digit of the Conductivity measurement value before filtering process is fluctuating, the fluctuation can be suppressed by using the filter time constant. <div style="display: flex; justify-content: space-around;"> <div style="text-align: center;">  <p>Conductivity measurement value</p> <p>Time (second)</p> <p>(Fig. 6.2-1)</p> </div> <div style="text-align: center;">  <p>Conductivity measurement value</p> <p>100% 63%</p> <p>Time (second)</p> <p>T</p> <p>(Fig. 6.2-2)</p> </div> </div> • Setting range: 0.0 to 10.0 seconds	0.0 sec
ESO 0.00	Conductivity input sensor correction • Sets conductivity input sensor correction value. This corrects the input value from the conductivity sensor. When a sensor cannot be set at the exact location where measurement is desired, conductivity measured by the sensor may deviate from the conductivity in the measured location. In this case, desired conductivity can be obtained by adding a sensor correction value. However, it is effective within the measurement range regardless of the sensor correction value. Conductivity after sensor correction= Current conductivity + (Sensor correction value) • Setting range: ±10% of measurement span (*)	0.00

(*) Measurement unit and decimal point place follow the measurement range.

6.3 Temperature Input Group

To enter the Temperature Input group, follow the procedure below.

- ① **G_EC** Press the MODE key in Conductivity/Temperature Display Mode.
- ② **G_TMP** Press the ▽ key in the Conductivity Input Group.
- ③ **SENS** Press the SET key.

The unit will enter the Temperature Input Group, and 'RTD type' will appear.

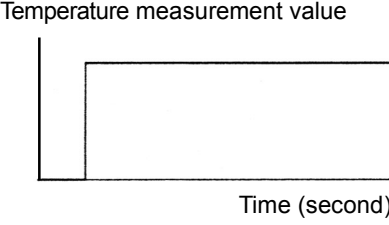
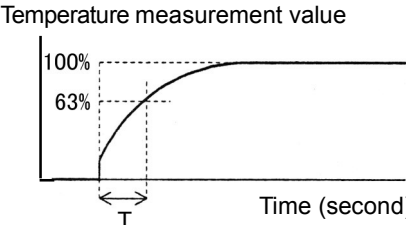

Character	Setting Item, Function, Setting Range	Factory Default
SENS PT100	RTD type • Selects RTD type of the Conductivity sensor. • PT100 : Pt100 PT1000 : Pt1000	Pt100
TCM NACL	Temperature compensation method • Selects Temperature compensation calculation method. • Selection items differ depending on the model. FEB-102-ECH: NACL : Temperature compensation is conducted using temperature characteristics of NaCl. Select when the main ingredient of salt included in a sample is NaCl. TCOE : Temperature compensation is conducted using temperature coefficient (%/°C) and randomly selected reference temperature. OFF : No temperature compensation FEB-102-ECM: NACL : Temperature compensation is conducted using temperature characteristics of NaCl. Select when the main ingredient of salt included in a sample is NaCl. TCOE : Temperature compensation is conducted using temperature coefficient (%/°C) and randomly selected reference temperature. PURE : Temperature compensation is conducted using temperature characteristics of pure (deionized) water. OFF : No temperature compensation	FEB-102-ECH: NaCl FEB-102-ECM: NaCl
KCOE 2.00	Temperature coefficient • Sets temperature coefficient. If Temperature coefficient is set to 2.00 %/°C, this value can be used for most aqueous solutions. If Temperature coefficient of an aqueous solution is known, set the value. If Temperature coefficient is set to 0.00 %/°C, conductivity without temperature compensation will be indicated. • Not available if NACL (NaCl) or OFF (No temperature compensation) is selected in [Temperature compensation method]. • Setting range: -5.00 to 5.00 %/°C	2.00 %/°C
STND 25.0	Reference temperature • Sets the reference temperature for temperature compensation. • Setting range: 5.0 to 95.0°C (*)	25.0°C
DP2 0.0	Decimal point place • Selects decimal point place. • 0 : No decimal point 0.0 : 1 digit after decimal point	1 digit after decimal point
CNECT 3WIRE	Pt100 input wire type • When PT100 (Pt100) is selected in [RTD type], selects the input wire type of Pt100. • Available only when PT100 (Pt100) is selected in [RTD type]. • 2WIRE : 2-wire type 3WIRE : 3-wire type	3-wire type

(*) The placement of the decimal point does not follow the selection. It is fixed.

Character	Setting Item, Function, Setting Range	Factory Default
CABLE 0.0	Cable length correction <ul style="list-style-type: none"> • Sets the cable length correction value. • Available only when 2WIRE (2-wire type) is selected in [Pt100 input wire type (p.23)]. • Setting range: 0.0 to 100.0 m 	0.0 m
CSEC 0.30	Cable cross-section area <ul style="list-style-type: none"> • Sets the cable cross-section area. • Available only when 2WIRE (2-wire type) is selected in [Pt100 input wire type (p.23)]. • Setting range: 0.10 to 2.00 mm² 	0.30 mm ²
FIT2 0.0	Temperature input filter time constant <ul style="list-style-type: none"> • Sets filter time constant of the temperature input. <p>Even when the Temperature measurement value changes as shown in (Fig. 6.3-1), if the filter time constant “T” is set, the Temperature measurement value changes so that it can reach 63% of the Temperature measurement value in T seconds as shown in (Fig. 6.3-2).</p> <p>If the value is set too large, it adversely affects EVT action due to the delay of response.</p> <p>(e.g.) If the lowest digit of the Temperature measurement value before filtering process is fluctuating, the fluctuation can be suppressed by using the filter time constant.</p> <div style="display: flex; justify-content: space-around; align-items: flex-end;"> <div style="text-align: center;">  <p>(Fig. 6.3-1)</p> </div> <div style="text-align: center;">  <p>(Fig. 6.3-2)</p> </div> </div> <ul style="list-style-type: none"> • Setting range: 0.0 to 10.0 seconds 	0.0 sec.

6.4 EVT1 Group

To enter EVT1 Group, follow the procedure below.

- ① **G_LEC** Press the  key in Conductivity/Temperature Display Mode.
- ② **G_E01** Press the  key twice in Conductivity Input Group.
- ③ **EVT1F** Press the  key.

The unit will enter EVT1 Group, and 'EVT1 type' will appear.

Character	Setting Item, Function, Setting Range	Factory Default															
EVT1F -----	EVT1 type <ul style="list-style-type: none"> • Selects an EVT1 output (Contact output 1) type. (Fig. 6.4-1) (p.29) Note: If EVT1 type is changed, EVT1 value will default to 0.00 or 0.0. • If OFF (No temperature compensation) is selected in [Temperature compensation method (p.23)], and if TEMPL (Temperature input low limit action) or TEMPH (Temperature input high limit action) is selected here, EVT1 action differs depending on the selection in [Temperature Display when no temperature compensation (p.49)]. If OFF (Unlit) or STD (Reference temperature) is selected, the unit operates based on the value set in [Reference temperature (p.23)]. If PV (Measurement value) is selected, the unit operates based on the Measurement value. • -----: No action EC-L: Conductivity input low limit action EC-H: Conductivity input high limit action TEMPL: Temperature input low limit action TEMPH: Temperature input high limit action EROUT: Error output [When the error type is "Error" (Table 6.4-1), the output is turned ON.] FAIL: Fail output [When the error type is "Fail" (Table 6.4-1), the output is turned ON.] EEUL: Conductivity input error alarm output • Error output, Fail output (Table 6.4-1) <table border="1" style="width: 100%; border-collapse: collapse;"> <thead> <tr> <th>Error Type</th> <th>Error Contents</th> <th>Description</th> </tr> </thead> <tbody> <tr> <td>Fail</td> <td>Temperature Sensor Burnout</td> <td>Temperature sensor lead wire is burnt out.</td> </tr> <tr> <td>Fail</td> <td>Temperature Sensor Short-circuited</td> <td>Temperature sensor lead wire is short-circuited.</td> </tr> <tr> <td>Error</td> <td>Outside Temperature Compensation Range</td> <td>Measured temperature has exceeded 110.0°C.</td> </tr> <tr> <td>Error</td> <td>Outside Temperature Compensation Range</td> <td>Measured temperature is less than 0.0°C.</td> </tr> </tbody> </table>	Error Type	Error Contents	Description	Fail	Temperature Sensor Burnout	Temperature sensor lead wire is burnt out.	Fail	Temperature Sensor Short-circuited	Temperature sensor lead wire is short-circuited.	Error	Outside Temperature Compensation Range	Measured temperature has exceeded 110.0°C.	Error	Outside Temperature Compensation Range	Measured temperature is less than 0.0°C.	No action
Error Type	Error Contents	Description															
Fail	Temperature Sensor Burnout	Temperature sensor lead wire is burnt out.															
Fail	Temperature Sensor Short-circuited	Temperature sensor lead wire is short-circuited.															
Error	Outside Temperature Compensation Range	Measured temperature has exceeded 110.0°C.															
Error	Outside Temperature Compensation Range	Measured temperature is less than 0.0°C.															
ESV1 0.00	EVT1 value <ul style="list-style-type: none"> • Selects an EVT1 value. • Available when EC-L (Conductivity input low limit action), EC-H (Conductivity input high limit action), TEMPL (Temperature input low limit action) or TEMPH (Temperature input high limit action) is selected in [EVT1 type]. • Setting range: Conductivity input: Measurement range low limit to Measurement range high limit (*1) Temperature input: 0.0 to 100.0°C (*2) 	Conductivity input: Measurement range low limit Temperature input: 0.0°C															
EP1 0.00	EVT1 proportional band <ul style="list-style-type: none"> • Sets EVT1 proportional band. ON/OFF control when set to 0.00 or 0.0. • Available when EC-L (Conductivity input low limit action), EC-H (Conductivity input high limit action), TEMPL (Temperature input low limit action) or TEMPH (Temperature input high limit action) is selected in [EVT1 type]. • Setting range: Conductivity input: 0 to Measurement span (*1) Temperature input: 0.0 to 100.0°C (*2) 	Conductivity input: Measurement range low limit Temperature input: 0.0°C															

(*1) Measurement unit and decimal point place follow the Measurement range.

(*2) The placement of the decimal point does not follow the selection. It is fixed.

Character	Setting Item, Function, Setting Range	Factory Default
E1RST □□□ 0.00	EVT1 reset <ul style="list-style-type: none"> • Sets the EVT1 reset value. • Available when EC-L□□ (Conductivity input low limit action), EC-H□□ (Conductivity input high limit action), TEMPL□ (Temperature input low limit action) or TEMPH□ (Temperature input high limit action) is selected in [EVT1 type]. • Not available for ON/OFF control. • Setting range: Conductivity input: ±10% of Measurement span (*1) Temperature input: ±100.0°C (*2) 	Conductivity input: 0 Temperature input: 0.0°C
E1DIF SDIF □□	EVT1 hysteresis type <ul style="list-style-type: none"> • Selects EVT1 output hysteresis type (Medium or Reference Value). (Fig. 6.4-1)(p.29) • Available when EC-L□□ (Conductivity input low limit action), EC-H□□ (Conductivity input high limit action), TEMPL□ (Temperature input low limit action) or TEMPH□ (Temperature input high limit action) is selected in [EVT1 type]. • Not available for P control. • CDIF□□: Medium Value Sets the same value for both ON and OFF sides in relation to EVT1 value. Only ON side needs to be set. • SDIF□□: Reference Value Sets individual values for ON and OFF sides in relation to EVT1 value. Both ON and OFF sides need to be set individually. 	Reference Value
E1DF0 □□□ 0.01	EVT1 ON side <ul style="list-style-type: none"> • Sets the span of EVT1 ON side. (Fig. 6.4-1)(p.29) If CDIF□□ (Medium Value) is selected in [EVT1 hysteresis type], the span of ON/OFF side will be the same value. • Available when EC-L□□ (Conductivity input low limit action), EC-H□□ (Conductivity input high limit action), TEMPL□ (Temperature input low limit action) or TEMPH□ (Temperature input high limit action) is selected in [EVT1 type]. • Not available for P control. • Setting range: Conductivity input: 0 to 20% of Measurement range high limit (*1) Temperature input: 0.0 to 10.0°C (*2) 	Conductivity input: 0.01 Temperature input: 1.0°C
E1DFU □□□ 0.01	EVT1 OFF side <ul style="list-style-type: none"> • Sets the span of EVT1 OFF side. (Fig. 6.4-1)(p.29) • Available when EC-L□□ (Conductivity input low limit action), EC-H□□ (Conductivity input high limit action), TEMPL□ (Temperature input low limit action) or TEMPH□ (Temperature input high limit action) is selected in [EVT1 type]. • Not available for P control. • Available when SDIF□□ (Reference Value) is selected in [EVT1 hysteresis type]. • Setting range: Conductivity input: 0 to 20% of Measurement range high limit (*1) Temperature input: 0.0 to 10.0°C (*2) 	Conductivity input: 0.01 Temperature input: 1.0°C
E1ONT □□□□ 0	EVT1 ON delay time <ul style="list-style-type: none"> • Sets EVT1 ON delay time. The EVT1 output does not turn ON (under the conditions of turning ON) until the time set in [EVT1 ON delay time] elapses. • Available when EC-L□□ (Conductivity input low limit action), EC-H□□ (Conductivity input high limit action), TEMPL□ (Temperature input low limit action) or TEMPH□ (Temperature input high limit action) is selected in [EVT1 type]. • Not available for P control. • Setting range: 0 to 10000 seconds 	0 sec.

(*1) Measurement unit and decimal point place follow the Measurement range.

(*2) The placement of the decimal point does not follow the selection. It is fixed.

Character	Setting Item, Function, Setting Range	Factory Default
E10FT □□□□□0	EVT1 OFF delay time • Sets EVT1 OFF delay time. The EVT1 output does not turn OFF (under the conditions of turning OFF) until the time set in [EVT1 OFF delay time] elapses. • Available when EC-L □□ (Conductivity input low limit action), EC-H □□ (Conductivity input high limit action), TEMPL □ (Temperature input low limit action) or TEMPH □ (Temperature input high limit action) is selected in [EVT1 type]. • Not available for P control. • Setting range: 0 to 10000 seconds	0 sec.
E1C□□ □□□30	EVT1 proportional cycle • Sets proportional cycle for EVT1. • Available when EC-L □□ (Conductivity input low limit action), EC-H □□ (Conductivity input high limit action), TEMPL □ (Temperature input low limit action) or TEMPH □ (Temperature input high limit action) is selected in [EVT1 type]. • Not available for ON/OFF control. • Setting range: 1 to 300 seconds	30 sec.
E10LH □□□100	EVT1 output high limit • Sets EVT1 output high limit value. • Available when EC-L □□ (Conductivity input low limit action), EC-H □□ (Conductivity input high limit action), TEMPL □ (Temperature input low limit action) or TEMPH □ (Temperature input high limit action) is selected in [EVT1 type]. • Not available for ON/OFF control. • Setting range: EVT1 output low limit value to 100%	100%
E10LL □□□□□0	EVT1 output low limit • Sets EVT1 output low limit value. • Available when EC-L □□ (Conductivity input low limit action), EC-H □□ (Conductivity input high limit action), TEMPL □ (Temperature input low limit action) or TEMPH □ (Temperature input high limit action) is selected in [EVT1 type]. • Not available for ON/OFF control. • Setting range: 0% to EVT1 output high limit value	0%
00NT1 □□□□□0	Output ON time when EVT1 output ON • Sets Output ON time when EVT1 output is ON. If ON time and OFF time are set, EVT1 output can be turned ON/OFF in a configured cycle when EVT1 output is ON. (Fig. 6.4-2)(p.29) • Available when EC-L □□ (Conductivity input low limit action), EC-H □□ (Conductivity input high limit action), TEMPL □ (Temperature input low limit action) or TEMPH □ (Temperature input high limit action) is selected in [EVT1 type]. • Not available for P control. • Setting range: 0 to 10000 seconds	0 sec.
00FT1 □□□□□0	Output OFF time when EVT1 output ON • Sets Output OFF time when EVT1 output is ON. If ON time and OFF time are set, EVT1 output can be turned ON/OFF in a configured cycle when EVT1 output is ON. (Fig. 6.4-2)(p.29) • Available when EC-L □□ (Conductivity input low limit action), EC-H □□ (Conductivity input high limit action), TEMPL □ (Temperature input low limit action) or TEMPH □ (Temperature input high limit action) is selected in [EVT1 type]. • Not available for P control. • Setting range: 0 to 10000 seconds	0 sec.
E1CS□ -----	EVT1 conductivity input error alarm EVT□ type • Selects an EVT□ type (except EVT1 type) in order to assess EVT1 conductivity input error alarm. • Available only when EEUL □□ (Conductivity input error alarm output) is selected in [EVT1 type] • ----- : No action EVT2 □□ : EVT2 type EVT3 □□ : EVT3 type (*1) EVT4 □□ : EVT4 type (*2)	No action

(*1) Available when EVT3 or EVT4 option is ordered.

(*2) Available when EVT4 option is ordered.

Character	Setting Item, Function, Setting Range	Factory Default
E1EO 0.00	EVT1 conductivity input error alarm span when EVT output ON <ul style="list-style-type: none"> Sets span to assess EVT1 conductivity input error alarm when EVT output is ON – which is selected in [EVT1 conductivity input error alarm EVT type]. Available only when EEUL (Conductivity input error alarm output) is selected in [EVT1 type] Setting range: Measurement range low limit to Measurement range high limit (*1) When set to 0.00, Conductivity input error alarm is disabled. 	Measurement range low limit
E1EOT 0	EVT1 conductivity input error alarm time when EVT output ON <ul style="list-style-type: none"> Sets time to assess EVT1 conductivity input error alarm when EVT output is ON – which is selected in [EVT1 conductivity input error alarm EVT type]. Available only when EEUL (Conductivity input error alarm output) is selected in [EVT1 type] Setting range: 0 to 10000 seconds or minutes Time unit follows the selection in [Conductivity input error alarm time unit]. When set to 0, Conductivity input error alarm is disabled. 	0 sec.
E1EC 0.00	EVT1 conductivity input error alarm span when EVT output OFF <ul style="list-style-type: none"> Sets span to assess EVT1 conductivity input error alarm when EVT output is OFF– which is selected in [EVT1 conductivity input error alarm EVT type]. Available only when EEUL (Conductivity input error alarm output) is selected in [EVT1 type] Setting range: Measurement range low limit to Measurement range high limit (*1) When set to 0.00, Conductivity input error alarm is disabled. 	Measurement range low limit
E1ECT 0	EVT1 conductivity input error alarm time when EVT output OFF <ul style="list-style-type: none"> Sets time to assess EVT1 conductivity input error alarm when EVT output is OFF– which is selected in [EVT1 conductivity input error alarm EVT type]. Available only when EEUL (Conductivity input error alarm output) is selected in [EVT1 type] Setting range: 0 to 10000 seconds or minutes (Time unit follows the selection in [Conductivity input error alarm time unit].) When set to 0, Conductivity input error alarm is disabled. 	0 sec.
MVZN1 50.0	EVT1 cycle variable range <ul style="list-style-type: none"> Sets EVT1 cycle range to be changed. Available when EC-L (Conductivity input low limit action), EC-H (Conductivity input high limit action), TEMP-L (Temperature input low limit action) or TEMP-H (Temperature input high limit action) is selected in [EVT1 type]. Not available for ON/OFF control. Setting range: 1.0 to 100.0% 	50.0%
CENT1 0	EVT1 cycle extended time <ul style="list-style-type: none"> Sets time to extend EVT1 cycle. Available when EC-L (Conductivity input low limit action), EC-H (Conductivity input high limit action), TEMP-L (Temperature input low limit action) or TEMP-H (Temperature input high limit action) is selected in [EVT1 type]. Not available for ON/OFF control. Setting range: 0 to 300 seconds 	0 sec.

(*1) Measurement unit and decimal point place follow the measurement range.

EVT1 Action

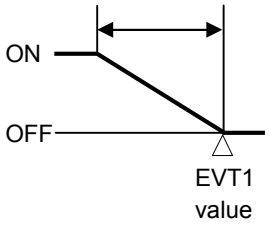
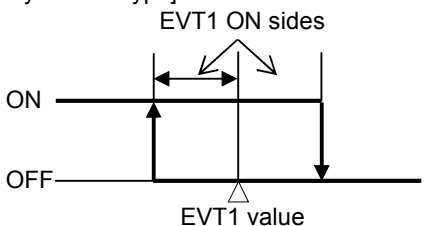
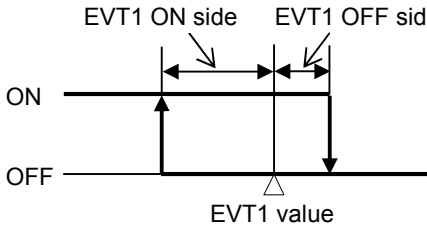
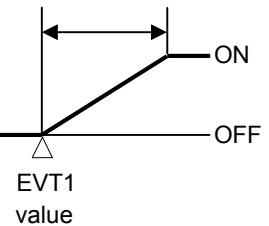
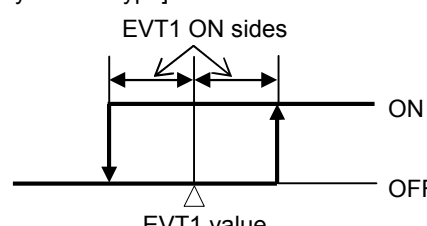
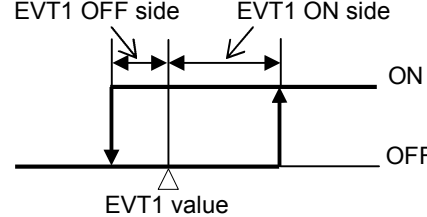
EVT1 Type	P Control Action	ON/OFF Control Action
Conductivity input low limit action, Temperature input low limit action	EVT1 proportional band 	If Medium Value is selected in [EVT1 hysteresis type]: 
		If Reference Value is selected in [EVT1 hysteresis type]: 
Conductivity input high limit action, Temperature input high limit action	EVT1 proportional band 	If Medium Value is selected in [EVT1 hysteresis type]: 
		If Reference Value is selected in [EVT1 hysteresis type]: 

(Fig. 6.4-1)

Timing chart of EVT1 output ON time and OFF time while in EVT1 output ON

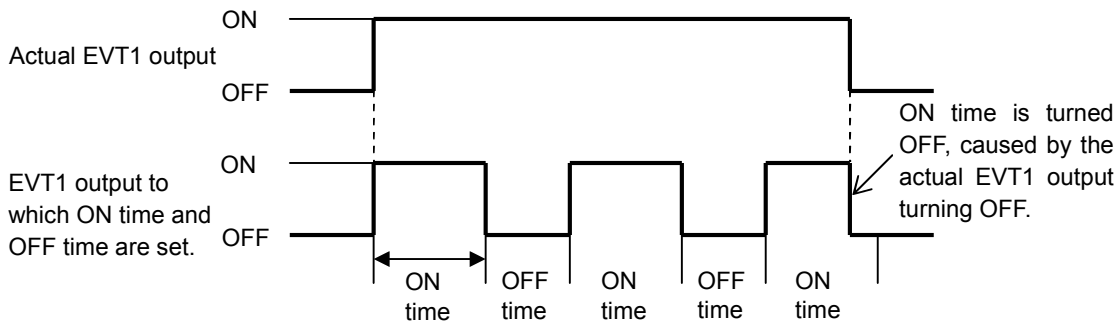

(Fig. 6.4-2)

6.5 EVT2 Group

To enter EVT2 Group, follow the procedure below.

- ① **G_EC** Press the MODE key in Conductivity/Temperature Display Mode.
- ② **G_E02** Press the key 3 times in Conductivity Input Group.
- ③ **EVT2F** Press the SET key.

The unit will enter EVT2 Group, and 'EVT2 type' will appear.

Character	Setting Item, Function, Setting Range	Factory Default															
EVT2F -----	<p>EVT2 type</p> <ul style="list-style-type: none"> Selects an EVT2 output (Contact output 2) type. (Fig. 6.5-1) (p.34) Note: If EVT2 type is changed, EVT2 value will default to 0.00 or 0.0. If OFF (No temperature compensation) is selected in [Temperature compensation method (p.23)], and if TEMPL (Temperature input low limit action) or TEMPH (Temperature input high limit action) is selected here, EVT2 action differs depending on the selection in [Temperature Display when no temperature compensation (p.49)]. <ul style="list-style-type: none"> If OFF (Unlit) or STD (Reference temperature) is selected, the unit operates based on the value set in [Reference temperature (p.23)]. If PV (Measurement value) is selected, the unit operates based on the Measurement value. -----: No action EC-L: Conductivity input low limit action EC-H: Conductivity input high limit action TEMPL: Temperature input low limit action TEMPH: Temperature input high limit action EROUT: Error output [When the error type is "Error" (Table 6.5-1), the output is turned ON.] FAIL: Fail output [When the error type is "Fail" (Table 6.5-1), the output is turned ON.] EEUL: Conductivity input error alarm output <p>• Error output, Fail output (Table 6.5-1)</p> <table border="1"> <thead> <tr> <th>Error Type</th> <th>Error Contents</th> <th>Description</th> </tr> </thead> <tbody> <tr> <td>Fail</td> <td>Temperature Sensor Burnout</td> <td>Temperature sensor lead wire is burnt out.</td> </tr> <tr> <td>Fail</td> <td>Temperature Sensor Short-circuited</td> <td>Temperature sensor lead wire is short-circuited.</td> </tr> <tr> <td>Error</td> <td>Outside Temperature Compensation Range</td> <td>Measured temperature has exceeded 110.0°C.</td> </tr> <tr> <td>Error</td> <td>Outside Temperature Compensation Range</td> <td>Measured temperature is less than 0.0°C.</td> </tr> </tbody> </table>	Error Type	Error Contents	Description	Fail	Temperature Sensor Burnout	Temperature sensor lead wire is burnt out.	Fail	Temperature Sensor Short-circuited	Temperature sensor lead wire is short-circuited.	Error	Outside Temperature Compensation Range	Measured temperature has exceeded 110.0°C.	Error	Outside Temperature Compensation Range	Measured temperature is less than 0.0°C.	No action
Error Type	Error Contents	Description															
Fail	Temperature Sensor Burnout	Temperature sensor lead wire is burnt out.															
Fail	Temperature Sensor Short-circuited	Temperature sensor lead wire is short-circuited.															
Error	Outside Temperature Compensation Range	Measured temperature has exceeded 110.0°C.															
Error	Outside Temperature Compensation Range	Measured temperature is less than 0.0°C.															
ESV2 <input type="checkbox"/> <input type="checkbox"/> <input type="checkbox"/> <input type="checkbox"/> 0.00	<p>EVT2 value</p> <ul style="list-style-type: none"> Selects an EVT2 value. Available when EC-L (Conductivity input low limit action), EC-H (Conductivity input high limit action), TEMPL (Temperature input low limit action) or TEMPH (Temperature input high limit action) is selected in [EVT2 type]. Setting range: Conductivity input: Measurement range low limit to Measurement range high limit (*1) Temperature input: 0.0 to 100.0°C (*2) 	Conductivity input: Measurement range low limit Temperature input: 0.0°C															
EP2 <input type="checkbox"/> <input type="checkbox"/> <input type="checkbox"/> <input type="checkbox"/> 0.00	<p>EVT2 proportional band</p> <ul style="list-style-type: none"> Sets EVT2 proportional band. ON/OFF control when set to 0.00 or 0.0. Available when EC-L (Conductivity input low limit action), EC-H (Conductivity input high limit action), TEMPL (Temperature input low limit action) or TEMPH (Temperature input high limit action) is selected in [EVT2 type]. Setting range: Conductivity input: 0 to Measurement span (*1) Temperature input: 0.0 to 100.0°C (*2) 	Conductivity input: Measurement range low limit Temperature input: 0.0°C															

(*1) Measurement unit and decimal point place follow the Measurement range.

(*2) The placement of the decimal point does not follow the selection. It is fixed.

Character	Setting Item, Function, Setting Range	Factory Default
E2RST □□□ 0.00	EVT2 reset <ul style="list-style-type: none"> • Sets the EVT2 reset value. • Available when EC-L□□ (Conductivity input low limit action), EC-H□□ (Conductivity input high limit action), TEMPL□ (Temperature input low limit action) or TEMPH□ (Temperature input high limit action) is selected in [EVT2 type]. • Not available for ON/OFF control. • Setting range: Conductivity input: ±10% of Measurement span (*1) Temperature input: ±100.0°C (*2) 	Conductivity input: 0 Temperature input: 0.0°C
E2DIF SDIF □□	EVT2 hysteresis type <ul style="list-style-type: none"> • Selects EVT2 output hysteresis type (Medium or Reference Value). (Fig. 6.5-1)(p.34) • Available when EC-L□□ (Conductivity input low limit action), EC-H□□ (Conductivity input high limit action), TEMPL□ (Temperature input low limit action) or TEMPH□ (Temperature input high limit action) is selected in [EVT2 type]. • Not available for P control. • CDIF□□: Medium Value Sets the same value for both ON and OFF sides in relation to EVT2 value. Only ON side needs to be set. • SDIF□□: Reference Value Sets individual values for ON and OFF sides in relation to EVT2 value. Both ON and OFF sides need to be set individually. 	Reference Value
E2DF0 □□□ 0.01	EVT2 ON side <ul style="list-style-type: none"> • Sets the span of EVT2 ON side. (Fig. 6.5-1)(p.34) If CDIF□□ (Medium Value) is selected in [EVT2 hysteresis type], the span of ON/OFF side will be the same value. • Available when EC-L□□ (Conductivity input low limit action), EC-H□□ (Conductivity input high limit action), TEMPL□ (Temperature input low limit action) or TEMPH□ (Temperature input high limit action) is selected in [EVT2 type]. • Not available for P control. • Setting range: Conductivity input: 0 to 20% of Measurement range high limit (*1) Temperature input: 0.0 to 10.0°C (*2) 	Conductivity input: 0.01 Temperature input: 1.0°C
E2DFU □□□ 0.01	EVT2 OFF side <ul style="list-style-type: none"> • Sets the span of EVT2 OFF side. (Fig. 6.5-1)(p.34) • Available when EC-L□□ (Conductivity input low limit action), EC-H□□ (Conductivity input high limit action), TEMPL□ (Temperature input low limit action) or TEMPH□ (Temperature input high limit action) is selected in [EVT2 type]. • Not available for P control. • Available when SDIF□□ (Reference Value) is selected in [EVT2 hysteresis type]. • Setting range: Conductivity input: 0 to 20% of Measurement range high limit (*1) Temperature input: 0.0 to 10.0°C (*2) 	Conductivity input: 0.01 Temperature input: 1.0°C
E2ONT □□□□ 0	EVT2 ON delay time <ul style="list-style-type: none"> • Sets EVT2 ON delay time. The EVT2 output does not turn ON (under the conditions of turning ON) until the time set in [EVT2 ON delay time] elapses. • Available when EC-L□□ (Conductivity input low limit action), EC-H□□ (Conductivity input high limit action), TEMPL□ (Temperature input low limit action) or TEMPH□ (Temperature input high limit action) is selected in [EVT2 type]. • Not available for P control. • Setting range: 0 to 10000 seconds 	0 sec.

(*1) Measurement unit and decimal point place follow the Measurement range.

(*2) The placement of the decimal point does not follow the selection. It is fixed.

Character	Setting Item, Function, Setting Range	Factory Default
E20FT □□□□0	EVT2 OFF delay time • Sets EVT2 OFF delay time. The EVT2 output does not turn OFF (under the conditions of turning OFF) until the time set in [EVT2 OFF delay time] elapses. • Available when EC-L □□ (Conductivity input low limit action), EC-H □□ (Conductivity input high limit action), TEMPL □ (Temperature input low limit action) or TEMPH □ (Temperature input high limit action) is selected in [EVT2 type]. • Not available for P control. • Setting range: 0 to 10000 seconds	0 sec.
E2C □ □□□30	EVT2 proportional cycle • Sets proportional cycle for EVT2. • Available when EC-L □□ (Conductivity input low limit action), EC-H □□ (Conductivity input high limit action), TEMPL □ (Temperature input low limit action) or TEMPH □ (Temperature input high limit action) is selected in [EVT2 type]. • Not available for ON/OFF control. • Setting range: 1 to 300 seconds	30 sec.
E20LH □□□100	EVT2 output high limit • Sets EVT2 output high limit value. • Available when EC-L □□ (Conductivity input low limit action), EC-H □□ (Conductivity input high limit action), TEMPL □ (Temperature input low limit action) or TEMPH □ (Temperature input high limit action) is selected in [EVT2 type]. • Not available for ON/OFF control. • Setting range: EVT2 output low limit value to 100%	100%
E20LL □□□□0	EVT2 output low limit • Sets EVT2 output low limit value. • Available when EC-L □□ (Conductivity input low limit action), EC-H □□ (Conductivity input high limit action), TEMPL □ (Temperature input low limit action) or TEMPH □ (Temperature input high limit action) is selected in [EVT2 type]. • Not available for ON/OFF control. • Setting range: 0% to EVT2 output high limit value	0%
00NT2 □□□□0	Output ON time when EVT2 output ON • Sets Output ON time when EVT2 output is ON. If ON time and OFF time are set, EVT2 output can be turned ON/OFF in a configured cycle when EVT2 output is ON. (Fig. 6.5-2)(p.34) • Available when EC-L □□ (Conductivity input low limit action), EC-H □□ (Conductivity input high limit action), TEMPL □ (Temperature input low limit action) or TEMPH □ (Temperature input high limit action) is selected in [EVT2 type]. • Not available for P control. • Setting range: 0 to 10000 seconds	0 sec.
00FT2 □□□□0	Output OFF time when EVT2 output ON • Sets Output OFF time when EVT2 output is ON. If ON time and OFF time are set, EVT2 output can be turned ON/OFF in a configured cycle when EVT2 output is ON. (Fig. 6.5-2)(p.34) • Available when EC-L □□ (Conductivity input low limit action), EC-H □□ (Conductivity input high limit action), TEMPL □ (Temperature input low limit action) or TEMPH □ (Temperature input high limit action) is selected in [EVT2 type]. • Not available for P control. • Setting range: 0 to 10000 seconds	0 sec.
E2CS □ -----	EVT2 conductivity input error alarm EVT□ type • Selects an EVT□ type (except EVT2 type) in order to assess EVT2 conductivity input error alarm. • Available only when EEUL □□ (Conductivity input error alarm output) is selected in [EVT2 type] • EVT1 □□ : EVT1 type ----- : No action EVT3 □□ : EVT3 type (*1) EVT4 □□ : EVT4 type (*2)	No action

(*1) Available when EVT3 or EVT4 option is ordered.

(*2) Available when EVT4 option is ordered.

Character	Setting Item, Function, Setting Range	Factory Default
E2E0 □□□□ 0.00	EVT2 conductivity input error alarm span when EVT□ output ON <ul style="list-style-type: none"> • Sets span to assess EVT2 conductivity input error alarm when EVT□ output is ON – which is selected in [EVT2 conductivity input error alarm EVT□ type]. • Available only when EEUL□□ (Conductivity input error alarm output) is selected in [EVT2 type] • Setting range: Measurement range low limit to Measurement range high limit (*1) When set to 0.00, Conductivity input error alarm is disabled. 	Measurement range low limit
E2E0T □□□□ 0	EVT2 conductivity input error alarm time when EVT□ output ON <ul style="list-style-type: none"> • Sets time to assess EVT2 conductivity input error alarm when EVT□ output is ON – which is selected in [EVT2 conductivity input error alarm EVT□ type]. • Available only when EEUL□□ (Conductivity input error alarm output) is selected in [EVT2 type] • Setting range: 0 to 10000 seconds or minutes Time unit follows the selection in [Conductivity input error alarm time unit]. When set to 0, Conductivity input error alarm is disabled. 	0 sec.
E2EC □□□□ 0.00	EVT2 conductivity input error alarm span when EVT□ output OFF <ul style="list-style-type: none"> • Sets span to assess EVT2 conductivity input error alarm when EVT□ output is OFF– which is selected in [EVT2 conductivity input error alarm EVT□ type]. • Available only when EEUL□□ (Conductivity input error alarm output) is selected in [EVT2 type] • Setting range: Measurement range low limit to Measurement range high limit (*1) When set to 0.00, Conductivity input error alarm is disabled. 	Measurement range low limit
E2ECT □□□□ 0	EVT2 conductivity input error alarm time when EVT□ output OFF <ul style="list-style-type: none"> • Sets time to assess EVT2 conductivity input error alarm when EVT□ output is OFF– which is selected in [EVT2 conductivity input error alarm EVT□ type]. • Available only when EEUL□□ (Conductivity input error alarm output) is selected in [EVT2 type] • Setting range: 0 to 10000 seconds or minutes (Time unit follows the selection in [Conductivity input error alarm time unit].) When set to 0, Conductivity input error alarm is disabled. 	0 sec.
MVZN2 □□□□ 50.0	EVT2 cycle variable range <ul style="list-style-type: none"> • Sets EVT2 cycle range to be changed. • Available when EC-L□□ (Conductivity input low limit action), EC-H□□ (Conductivity input high limit action), TEMP-L□ (Temperature input low limit action) or TEMP-H□ (Temperature input high limit action) is selected in [EVT2 type]. • Not available for ON/OFF control. • Setting range: 1.0 to 100.0% 	50.0%
CENT2 □□□□ 0	EVT2 cycle extended time <ul style="list-style-type: none"> • Sets time to extend EVT2 cycle. • Available when EC-L□□ (Conductivity input low limit action), EC-H□□ (Conductivity input high limit action), TEMP-L□ (Temperature input low limit action) or TEMP-H□ (Temperature input high limit action) is selected in [EVT2 type]. • Not available for ON/OFF control. • Setting range: 0 to 300 seconds 	0 sec.

(*1) Measurement unit and decimal point place follow the measurement range.

EVT2 Action

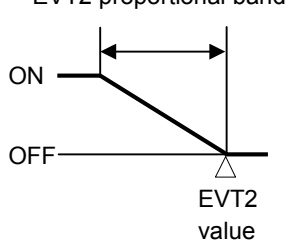
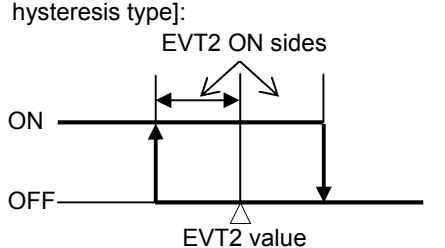
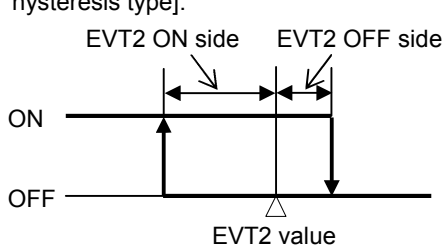
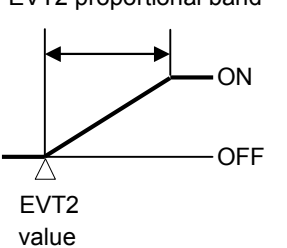
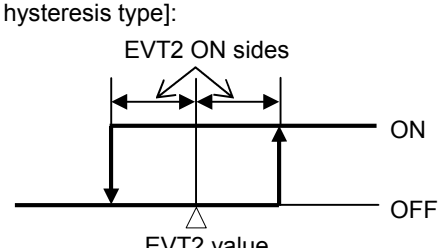
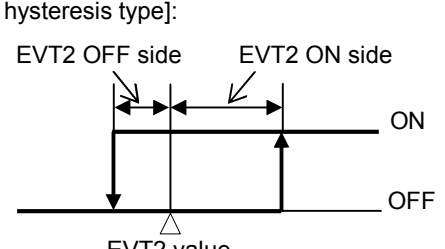
EVT2 Type	P Control Action	ON/OFF Control Action
Conductivity input low limit action, Temperature input low limit action	EVT2 proportional band 	If Medium Value is selected in [EVT2 hysteresis type]: 
		If Reference Value is selected in [EVT2 hysteresis type]: 
Conductivity input high limit action, Temperature input high limit action	EVT2 proportional band 	If Medium Value is selected in [EVT2 hysteresis type]: 
		If Reference Value is selected in [EVT2 hysteresis type]: 

(Fig. 6.5-1)

Timing chart of EVT2 output ON time and OFF time while in EVT2 output ON

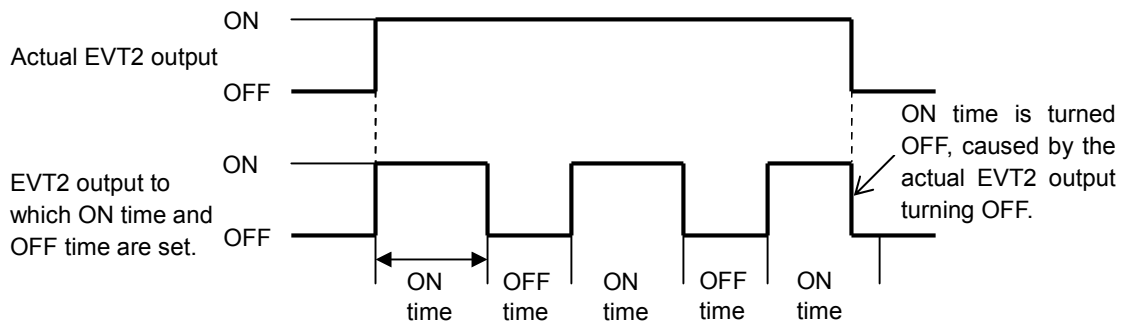

(Fig. 6.5-2)

6.6 EVT3 Group

Available when EVT3 or EVT4 option is ordered.

To enter EVT3 Group, follow the procedure below.

- ① **G_EC** Press the key in Conductivity/Temperature Display Mode.
- ② **G_E03** Press the key 4 times in Conductivity Input Group.
- ③ **EVT3F** Press the key.

The unit will enter EVT3 Group, and 'EVT3 type' will appear.

Character	Setting Item, Function, Setting Range	Factory Default															
EVT3F -----	EVT3 type <ul style="list-style-type: none"> • Selects an EVT3 output (Contact output 3) type. (Fig. 6.6-1) (p.39) Note: If EVT3 type is changed, EVT3 value will default to 0.00 or 0.0. • If OFF (No temperature compensation) is selected in [Temperature compensation method (p.23)], and if TEMPL (Temperature input low limit action) or TEMPH (Temperature input high limit action) is selected here, EVT3 action differs depending on the selection in [Temperature Display when no temperature compensation (p.49)]. <ul style="list-style-type: none"> If OFF (Unlit) or STD (Reference temperature) is selected, the unit operates based on the value set in [Reference temperature (p.23)]. If PV (Measurement value) is selected, the unit operates based on the Measurement value. • -----: No action EC-L: Conductivity input low limit action EC-H: Conductivity input high limit action TEMPL: Temperature input low limit action TEMPH: Temperature input high limit action EROUT: Error output [When the error type is "Error" (Table 6.6-1), the output is turned ON.] FAIL: Fail output [When the error type is "Fail" (Table 6.6-1), the output is turned ON.] EEUL: Conductivity input error alarm output 	No action															
	<ul style="list-style-type: none"> • Error output, Fail output (Table 6.6-1) <table border="1"> <thead> <tr> <th>Error Type</th> <th>Error Contents</th> <th>Description</th> </tr> </thead> <tbody> <tr> <td>Fail</td> <td>Temperature Sensor Burnout</td> <td>Temperature sensor lead wire is burnt out.</td> </tr> <tr> <td>Fail</td> <td>Temperature Sensor Short-circuited</td> <td>Temperature sensor lead wire is short-circuited.</td> </tr> <tr> <td>Error</td> <td>Outside Temperature Compensation Range</td> <td>Measured temperature has exceeded 110.0°C.</td> </tr> <tr> <td>Error</td> <td>Outside Temperature Compensation Range</td> <td>Measured temperature is less than 0.0°C.</td> </tr> </tbody> </table>	Error Type	Error Contents	Description	Fail	Temperature Sensor Burnout	Temperature sensor lead wire is burnt out.	Fail	Temperature Sensor Short-circuited	Temperature sensor lead wire is short-circuited.	Error	Outside Temperature Compensation Range	Measured temperature has exceeded 110.0°C.	Error	Outside Temperature Compensation Range	Measured temperature is less than 0.0°C.	
Error Type	Error Contents	Description															
Fail	Temperature Sensor Burnout	Temperature sensor lead wire is burnt out.															
Fail	Temperature Sensor Short-circuited	Temperature sensor lead wire is short-circuited.															
Error	Outside Temperature Compensation Range	Measured temperature has exceeded 110.0°C.															
Error	Outside Temperature Compensation Range	Measured temperature is less than 0.0°C.															
ESV3 <input type="text" value="0.00"/>	EVT3 value <ul style="list-style-type: none"> • Selects an EVT3 value. • Available when EC-L (Conductivity input low limit action), EC-H (Conductivity input high limit action), TEMPL (Temperature input low limit action) or TEMPH (Temperature input high limit action) is selected in [EVT3 type]. • Setting range: Conductivity input: Measurement range low limit to Measurement range high limit (*1) Temperature input: 0.0 to 100.0°C (*2) 	Conductivity input: Measurement range low limit Temperature input: 0.0°C															
EP3 <input type="text" value="0.00"/>	EVT3 proportional band <ul style="list-style-type: none"> • Sets EVT3 proportional band. ON/OFF control when set to 0.00 or 0.0. • Available when EC-L (Conductivity input low limit action), EC-H (Conductivity input high limit action), TEMPL (Temperature input low limit action) or TEMPH (Temperature input high limit action) is selected in [EVT3 type]. • Setting range: Conductivity input: 0 to Measurement span (*1) Temperature input: 0.0 to 100.0°C (*2) 	Conductivity input: Measurement range low limit Temperature input: 0.0°C															

(*1) Measurement unit and decimal point place follow the Measurement range.

(*2) The placement of the decimal point does not follow the selection. It is fixed.

Character	Setting Item, Function, Setting Range	Factory Default
E3RST □□□ 0.00	EVT3 reset <ul style="list-style-type: none"> • Sets the EVT3 reset value. • Available when EC-L□□ (Conductivity input low limit action), EC-H□□ (Conductivity input high limit action), TEMPL□ (Temperature input low limit action) or TEMPH□ (Temperature input high limit action) is selected in [EVT3 type]. • Not available for ON/OFF control. • Setting range: Conductivity input: ±10% of Measurement span (*1) Temperature input: ±100.0°C (*2) 	Conductivity input: 0 Temperature input: 0.0°C
E3DIF SDIF □□	EVT3 hysteresis type <ul style="list-style-type: none"> • Selects EVT3 output hysteresis type (Medium or Reference Value). (Fig. 6.6-1)(p.39) • Available when EC-L□□ (Conductivity input low limit action), EC-H□□ (Conductivity input high limit action), TEMPL□ (Temperature input low limit action) or TEMPH□ (Temperature input high limit action) is selected in [EVT3 type]. • Not available for P control. • CDIF□□: Medium Value Sets the same value for both ON and OFF sides in relation to EVT3 value. Only ON side needs to be set. • SDIF□□: Reference Value Sets individual values for ON and OFF sides in relation to EVT3 value. Both ON and OFF sides need to be set individually. 	Reference Value
E3DF0 □□□ 0.01	EVT3 ON side <ul style="list-style-type: none"> • Sets the span of EVT3 ON side. (Fig. 6.6-1)(p.39) If CDIF□□ (Medium Value) is selected in [EVT3 hysteresis type], the span of ON/OFF side will be the same value. • Available when EC-L□□ (Conductivity input low limit action), EC-H□□ (Conductivity input high limit action), TEMPL□ (Temperature input low limit action) or TEMPH□ (Temperature input high limit action) is selected in [EVT3 type]. • Not available for P control. • Setting range: Conductivity input: 0 to 20% of Measurement range high limit (*1) Temperature input: 0.0 to 10.0°C (*2) 	Conductivity input: 0.01 Temperature input: 1.0°C
E3DFU □□□ 0.01	EVT3 OFF side <ul style="list-style-type: none"> • Sets the span of EVT3 OFF side. (Fig. 6.6-1)(p.39) • Available when EC-L□□ (Conductivity input low limit action), EC-H□□ (Conductivity input high limit action), TEMPL□ (Temperature input low limit action) or TEMPH□ (Temperature input high limit action) is selected in [EVT3 type]. • Not available for P control. • Available when SDIF□□ (Reference Value) is selected in [EVT3 hysteresis type]. • Setting range: Conductivity input: 0 to 20% of Measurement range high limit (*1) Temperature input: 0.0 to 10.0°C (*2) 	Conductivity input: 0.01 Temperature input: 1.0°C
E3ONT □□□□ 0	EVT3 ON delay time <ul style="list-style-type: none"> • Sets EVT3 ON delay time. The EVT3 output does not turn ON (under the conditions of turning ON) until the time set in [EVT3 ON delay time] elapses. • Available when EC-L□□ (Conductivity input low limit action), EC-H□□ (Conductivity input high limit action), TEMPL□ (Temperature input low limit action) or TEMPH□ (Temperature input high limit action) is selected in [EVT3 type]. • Not available for P control. • Setting range: 0 to 10000 seconds 	0 sec.

(*1) Measurement unit and decimal point place follow the Measurement range.

(*2) The placement of the decimal point does not follow the selection. It is fixed.

Character	Setting Item, Function, Setting Range	Factory Default
E30FT □□□□□0	EVT3 OFF delay time • Sets EVT3 OFF delay time. The EVT3 output does not turn OFF (under the conditions of turning OFF) until the time set in [EVT3 OFF delay time] elapses. • Available when EC-L □□ (Conductivity input low limit action), EC-H □□ (Conductivity input high limit action), TEMPL □ (Temperature input low limit action) or TEMPH □ (Temperature input high limit action) is selected in [EVT3 type]. • Not available for P control. • Setting range: 0 to 10000 seconds	0 sec.
E3C□□ □□□30	EVT3 proportional cycle • Sets proportional cycle for EVT3. • Available when EC-L □□ (Conductivity input low limit action), EC-H □□ (Conductivity input high limit action), TEMPL □ (Temperature input low limit action) or TEMPH □ (Temperature input high limit action) is selected in [EVT3 type]. • Not available for ON/OFF control. • Setting range: 1 to 300 seconds	30 sec.
E30LH □□□100	EVT3 output high limit • Sets EVT3 output high limit value. • Available when EC-L □□ (Conductivity input low limit action), EC-H □□ (Conductivity input high limit action), TEMPL □ (Temperature input low limit action) or TEMPH □ (Temperature input high limit action) is selected in [EVT3 type]. • Not available for ON/OFF control. • Setting range: EVT3 output low limit value to 100%	100%
E30LL □□□□□0	EVT3 output low limit • Sets EVT3 output low limit value. • Available when EC-L □□ (Conductivity input low limit action), EC-H □□ (Conductivity input high limit action), TEMPL □ (Temperature input low limit action) or TEMPH □ (Temperature input high limit action) is selected in [EVT3 type]. • Not available for ON/OFF control. • Setting range: 0% to EVT3 output high limit value	0%
00NT3 □□□□□0	Output ON time when EVT3 output ON • Sets Output ON time when EVT3 output is ON. If ON time and OFF time are set, EVT3 output can be turned ON/OFF in a configured cycle when EVT3 output is ON. (Fig. 6.6-2)(p.39) • Available when EC-L □□ (Conductivity input low limit action), EC-H □□ (Conductivity input high limit action), TEMPL □ (Temperature input low limit action) or TEMPH □ (Temperature input high limit action) is selected in [EVT3 type]. • Not available for P control. • Setting range: 0 to 10000 seconds	0 sec.
00FT3 □□□□□0	Output OFF time when EVT3 output ON • Sets Output OFF time when EVT3 output is ON. If ON time and OFF time are set, EVT3 output can be turned ON/OFF in a configured cycle when EVT3 output is ON. (Fig. 6.6-2)(p.39) • Available when EC-L □□ (Conductivity input low limit action), EC-H □□ (Conductivity input high limit action), TEMPL □ (Temperature input low limit action) or TEMPH □ (Temperature input high limit action) is selected in [EVT3 type]. • Not available for P control. • Setting range: 0 to 10000 seconds	0 sec.
E3CS□ -----	EVT3 conductivity input error alarm EVT□ type • Selects an EVT□ type (except EVT3 type) in order to assess EVT3 conductivity input error alarm. • Available only when EEUL □□ (Conductivity input error alarm output) is selected in [EVT3 type] • EVT1 □□ : EVT1 type EVT2 □□ : EVT2 type ----- : No action EVT4 □□ : EVT4 type (*1)	No action

(*1) Available when EVT4 option is ordered.

Character	Setting Item, Function, Setting Range	Factory Default
E3E0 □□□□ 0.00	EVT3 conductivity input error alarm span when EVT□ output ON <ul style="list-style-type: none"> • Sets span to assess EVT3 conductivity input error alarm when EVT□ output is ON – which is selected in [EVT3 conductivity input error alarm EVT□ type]. • Available only when EEUL□□ (Conductivity input error alarm output) is selected in [EVT3 type] • Setting range: Measurement range low limit to Measurement range high limit (*1) When set to 0.00, Conductivity input error alarm is disabled. 	Measurement range low limit
E3E0T □□□□ 0	EVT3 conductivity input error alarm time when EVT□ output ON <ul style="list-style-type: none"> • Sets time to assess EVT3 conductivity input error alarm when EVT□ output is ON – which is selected in [EVT3 conductivity input error alarm EVT□ type]. • Available only when EEUL□□ (Conductivity input error alarm output) is selected in [EVT3 type] • Setting range: 0 to 10000 seconds or minutes Time unit follows the selection in [Conductivity input error alarm time unit]. When set to 0, Conductivity input error alarm is disabled. 	0 sec.
E3EC □□□□ 0.00	EVT3 conductivity input error alarm span when EVT□ output OFF <ul style="list-style-type: none"> • Sets span to assess EVT3 conductivity input error alarm when EVT□ output is OFF– which is selected in [EVT3 conductivity input error alarm EVT□ type]. • Available only when EEUL□□ (Conductivity input error alarm output) is selected in [EVT3 type] • Setting range: Measurement range low limit to Measurement range high limit (*1) When set to 0.00, Conductivity input error alarm is disabled. 	Measurement range low limit
E3ECT □□□□ 0	EVT3 conductivity input error alarm time when EVT□ output OFF <ul style="list-style-type: none"> • Sets time to assess EVT3 conductivity input error alarm when EVT□ output is OFF– which is selected in [EVT3 conductivity input error alarm EVT□ type]. • Available only when EEUL□□ (Conductivity input error alarm output) is selected in [EVT3 type] • Setting range: 0 to 10000 seconds or minutes Time unit follows the selection in [Conductivity input error alarm time unit]. When set to 0, Conductivity input error alarm is disabled. 	0 sec.
MVZN3 □□□□ 50.0	EVT3 cycle variable range <ul style="list-style-type: none"> • Sets EVT3 cycle range to be changed. • Available when EC-L□□ (Conductivity input low limit action), EC-H□□ (Conductivity input high limit action), TEMP-L□ (Temperature input low limit action) or TEMP-H□ (Temperature input high limit action) is selected in [EVT3 type]. • Not available for ON/OFF control. • Setting range: 1.0 to 100.0% 	50.0%
CENT3 □□□□ 0	EVT3 cycle extended time <ul style="list-style-type: none"> • Sets time to extend EVT3 cycle. • Available when EC-L□□ (Conductivity input low limit action), EC-H□□ (Conductivity input high limit action), TEMP-L□ (Temperature input low limit action) or TEMP-H□ (Temperature input high limit action) is selected in [EVT3 type]. • Not available for ON/OFF control. • Setting range: 0 to 300 seconds 	0 sec.

(*1) Measurement unit and decimal point place follow the measurement range.

EVT3 Action

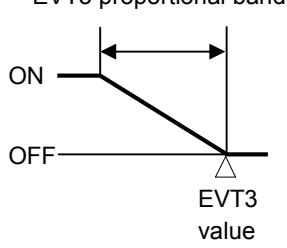
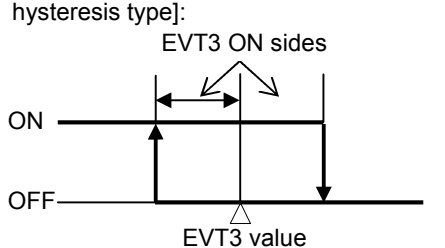
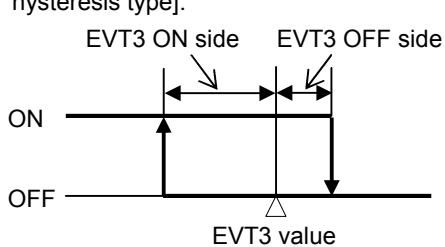
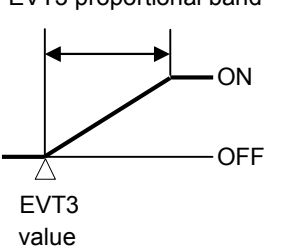
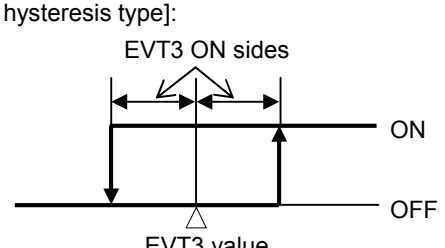
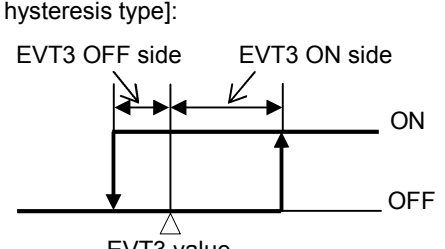
EVT3 Type	P Control Action	ON/OFF Control Action
Conductivity input low limit action, Temperature input low limit action	EVT3 proportional band 	If Medium Value is selected in [EVT3 hysteresis type]: 
		If Reference Value is selected in [EVT3 hysteresis type]: 
Conductivity input high limit action, Temperature input high limit action	EVT3 proportional band 	If Medium Value is selected in [EVT3 hysteresis type]: 
		If Reference Value is selected in [EVT3 hysteresis type]: 

(Fig. 6.6-1)

Timing chart of EVT3 output ON time and OFF time while in EVT3 output ON

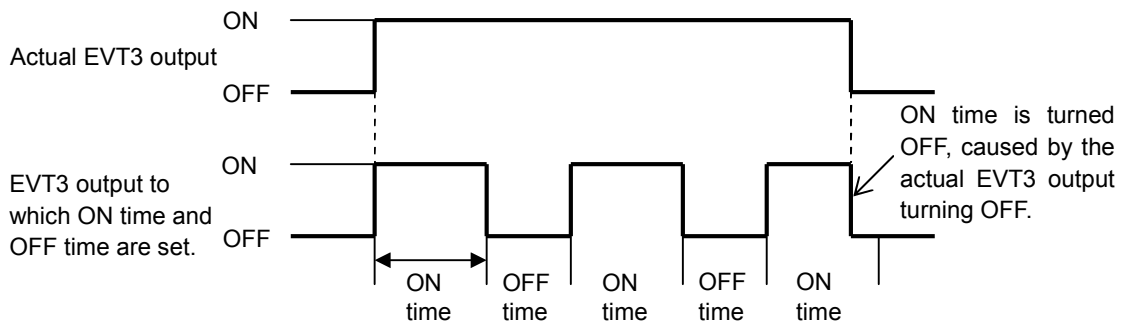

(Fig. 6.6-2)

6.7 EVT4 Group

Available when EVT4 option is ordered.

To enter EVT4 Group, follow the procedure below.

- ① **G_EC** Press the **MODE** key in Conductivity/Temperature Display Mode.
- ② **G_E04** Press the **▽** key 5 times in Conductivity Input Group.
- ③ **EVT4F** Press the **SET** key.

The unit will enter EVT4 Group, and 'EVT4 type' will appear.

Character	Setting Item, Function, Setting Range	Factory Default															
EVT4F -----	EVT4 type <ul style="list-style-type: none"> • Selects an EVT4 output (Contact output 4) type. (Fig. 6.7-1) (p.44) Note: If EVT4 type is changed, EVT4 value will default to 0.00 or 0.0. • If OFF (No temperature compensation) is selected in [Temperature compensation method (p.23)], and if TEMPL (Temperature input low limit action) or TEMPH (Temperature input high limit action) is selected here, EVT4 action differs depending on the selection in [Temperature Display when no temperature compensation (p.49)]. <ul style="list-style-type: none"> If OFF (Unlit) or STD (Reference temperature) is selected, the unit operates based on the value set in [Reference temperature (p.23)]. If PV (Measurement value) is selected, the unit operates based on the Measurement value. • -----: No action EC-L: Conductivity input low limit action EC-H: Conductivity input high limit action TEMPL: Temperature input low limit action TEMPH: Temperature input high limit action EROUT: Error output [When the error type is "Error" (Table 6.7-1), the output is turned ON.] FAIL: Fail output [When the error type is "Fail" (Table 6.7-1), the output is turned ON.] EEUL: Conductivity input error alarm output <ul style="list-style-type: none"> • Error output, Fail output (Table 6.7-1) <table border="1" style="width: 100%; border-collapse: collapse;"> <thead> <tr> <th>Error Type</th> <th>Error Contents</th> <th>Description</th> </tr> </thead> <tbody> <tr> <td>Fail</td> <td>Temperature Sensor Burnout</td> <td>Temperature sensor lead wire is burnt out.</td> </tr> <tr> <td>Fail</td> <td>Temperature Sensor Short-circuited</td> <td>Temperature sensor lead wire is short-circuited.</td> </tr> <tr> <td>Error</td> <td>Outside Temperature Compensation Range</td> <td>Measured temperature has exceeded 110.0°C.</td> </tr> <tr> <td>Error</td> <td>Outside Temperature Compensation Range</td> <td>Measured temperature is less than 0.0°C.</td> </tr> </tbody> </table>	Error Type	Error Contents	Description	Fail	Temperature Sensor Burnout	Temperature sensor lead wire is burnt out.	Fail	Temperature Sensor Short-circuited	Temperature sensor lead wire is short-circuited.	Error	Outside Temperature Compensation Range	Measured temperature has exceeded 110.0°C.	Error	Outside Temperature Compensation Range	Measured temperature is less than 0.0°C.	No action
Error Type	Error Contents	Description															
Fail	Temperature Sensor Burnout	Temperature sensor lead wire is burnt out.															
Fail	Temperature Sensor Short-circuited	Temperature sensor lead wire is short-circuited.															
Error	Outside Temperature Compensation Range	Measured temperature has exceeded 110.0°C.															
Error	Outside Temperature Compensation Range	Measured temperature is less than 0.0°C.															
ESV4 0.00	EVT4 value <ul style="list-style-type: none"> • Selects an EVT4 value. • Available when EC-L (Conductivity input low limit action), EC-H (Conductivity input high limit action), TEMPL (Temperature input low limit action) or TEMPH (Temperature input high limit action) is selected in [EVT4 type]. • Setting range: Conductivity input: Measurement range low limit to Measurement range high limit (*1) Temperature input: 0.0 to 100.0°C (*2) 	Conductivity input: Measurement range low limit Temperature input: 0.0°C															
EP4 0.00	EVT4 proportional band <ul style="list-style-type: none"> • Sets EVT4 proportional band. ON/OFF control when set to 0.00 or 0.0. • Available when EC-L (Conductivity input low limit action), EC-H (Conductivity input high limit action), TEMPL (Temperature input low limit action) or TEMPH (Temperature input high limit action) is selected in [EVT4 type]. • Setting range: Conductivity input: 0 to Measurement span (*1) Temperature input: 0.0 to 100.0°C (*2) 	Conductivity input: Measurement range low limit Temperature input: 0.0°C															

(*1) Measurement unit and decimal point place follow the Measurement range.

(*2) The placement of the decimal point does not follow the selection. It is fixed.

Character	Setting Item, Function, Setting Range	Factory Default
E4RST □□□ 0.00	EVT4 reset <ul style="list-style-type: none"> • Sets the EVT4 reset value. • Available when EC-L□□ (Conductivity input low limit action), EC-H□□ (Conductivity input high limit action), TEMPL□ (Temperature input low limit action) or TEMPH□ (Temperature input high limit action) is selected in [EVT4 type]. • Not available for ON/OFF control. • Setting range: Conductivity input: ±10% of Measurement span (*1) Temperature input: ±100.0°C (*2) 	Conductivity input: 0 Temperature input: 0.0°C
E4DIF SDIF □□	EVT4 hysteresis type <ul style="list-style-type: none"> • Selects EVT4 output hysteresis type (Medium or Reference Value). (Fig. 6.7-1)(p.44) • Available when EC-L□□ (Conductivity input low limit action), EC-H□□ (Conductivity input high limit action), TEMPL□ (Temperature input low limit action) or TEMPH□ (Temperature input high limit action) is selected in [EVT4 type]. • Not available for P control. • CDIF□□: Medium Value Sets the same value for both ON and OFF sides in relation to EVT4 value. Only ON side needs to be set. • SDIF□□: Reference Value Sets individual values for ON and OFF sides in relation to EVT4 value. Both ON and OFF sides need to be set individually. 	Reference Value
E4DF0 □□□ 0.01	EVT4 ON side <ul style="list-style-type: none"> • Sets the span of EVT4 ON side. (Fig. 6.7-1)(p.44) If CDIF□□ (Medium Value) is selected in [EVT4 hysteresis type], the span of ON/OFF side will be the same value. • Available when EC-L□□ (Conductivity input low limit action), EC-H□□ (Conductivity input high limit action), TEMPL□ (Temperature input low limit action) or TEMPH□ (Temperature input high limit action) is selected in [EVT4 type]. • Not available for P control. • Setting range: Conductivity input: 0 to 20% of Measurement range high limit (*1) Temperature input: 0.0 to 10.0°C (*2) 	Conductivity input: 0.01 Temperature input: 1.0°C
E4DFU □□□ 0.01	EVT4 OFF side <ul style="list-style-type: none"> • Sets the span of EVT4 OFF side. (Fig. 6.7-1)(p.44) • Available when EC-L□□ (Conductivity input low limit action), EC-H□□ (Conductivity input high limit action), TEMPL□ (Temperature input low limit action) or TEMPH□ (Temperature input high limit action) is selected in [EVT4 type]. • Not available for P control. • Available when SDIF□□ (Reference Value) is selected in [EVT4 hysteresis type]. • Setting range: Conductivity input: 0 to 20% of Measurement range high limit (*1) Temperature input: 0.0 to 10.0°C (*2) 	Conductivity input: 0.01 Temperature input: 1.0°C
E4ONT □□□□ 0	EVT4 ON delay time <ul style="list-style-type: none"> • Sets EVT4 ON delay time. The EVT4 output does not turn ON (under the conditions of turning ON) until the time set in [EVT4 ON delay time] elapses. • Available when EC-L□□ (Conductivity input low limit action), EC-H□□ (Conductivity input high limit action), TEMPL□ (Temperature input low limit action) or TEMPH□ (Temperature input high limit action) is selected in [EVT4 type]. • Not available for P control. • Setting range: 0 to 10000 seconds 	0 sec.

(*1) Measurement unit and decimal point place follow the Measurement range.

(*2) The placement of the decimal point does not follow the selection. It is fixed.

Character	Setting Item, Function, Setting Range	Factory Default
E40FT □□□□□0	EVT4 OFF delay time • Sets EVT4 OFF delay time. The EVT4 output does not turn OFF (under the conditions of turning OFF) until the time set in [EVT4 OFF delay time] elapses. • Available when EC-L □□ (Conductivity input low limit action), EC-H □□ (Conductivity input high limit action), TEMPL □ (Temperature input low limit action) or TEMPH □ (Temperature input high limit action) is selected in [EVT4 type]. • Not available for P control. • Setting range: 0 to 10000 seconds	0 sec.
E4C □□ □□□□30	EVT4 proportional cycle • Sets proportional cycle for EVT4. • Available when EC-L □□ (Conductivity input low limit action), EC-H □□ (Conductivity input high limit action), TEMPL □ (Temperature input low limit action) or TEMPH □ (Temperature input high limit action) is selected in [EVT4 type]. • Not available for ON/OFF control. • Setting range: 1 to 300 seconds	30 sec.
E40LH □□□□100	EVT4 output high limit • Sets EVT4 output high limit value. • Available when EC-L □□ (Conductivity input low limit action), EC-H □□ (Conductivity input high limit action), TEMPL □ (Temperature input low limit action) or TEMPH □ (Temperature input high limit action) is selected in [EVT4 type]. • Not available for ON/OFF control. • Setting range: EVT4 output low limit value to 100%	100%
E40LL □□□□□0	EVT4 output low limit • Sets EVT4 output low limit value. • Available when EC-L □□ (Conductivity input low limit action), EC-H □□ (Conductivity input high limit action), TEMPL □ (Temperature input low limit action) or TEMPH □ (Temperature input high limit action) is selected in [EVT4 type]. • Not available for ON/OFF control. • Setting range: 0% to EVT4 output high limit value	0%
00NT4 □□□□□0	Output ON time when EVT4 output ON • Sets Output ON time when EVT4 output is ON. If ON time and OFF time are set, EVT4 output can be turned ON/OFF in a configured cycle when EVT4 output is ON. (Fig. 6.7-2)(p.44) • Available when EC-L □□ (Conductivity input low limit action), EC-H □□ (Conductivity input high limit action), TEMPL □ (Temperature input low limit action) or TEMPH □ (Temperature input high limit action) is selected in [EVT4 type]. • Not available for P control. • Setting range: 0 to 10000 seconds	0 sec.
00FT1 □□□□□0	Output OFF time when EVT4 output ON • Sets Output OFF time when EVT4 output is ON. If ON time and OFF time are set, EVT4 output can be turned ON/OFF in a configured cycle when EVT4 output is ON. (Fig. 6.7-2)(p.44) • Available when EC-L □□ (Conductivity input low limit action), EC-H □□ (Conductivity input high limit action), TEMPL □ (Temperature input low limit action) or TEMPH □ (Temperature input high limit action) is selected in [EVT4 type]. • Not available for P control. • Setting range: 0 to 10000 seconds	0 sec.
E4CS □□ -----	EVT4 conductivity input error alarm EVT □ type • Selects an EVT□ type (except EVT4 type) in order to assess EVT4 conductivity input error alarm. • Available only when EEUL □□ (Conductivity input error alarm output) is selected in [EVT4 type] • EVT1 □□ : EVT1 type EVT2 □□ : EVT2 type EVT3 □□ : EVT3 type ----- : No action	No action

Character	Setting Item, Function, Setting Range	Factory Default
E4E0 □□□□ 0.00	EVT4 conductivity input error alarm span when EVT□ output ON <ul style="list-style-type: none"> • Sets span to assess EVT4 conductivity input error alarm when EVT□ output is ON – which is selected in [EVT4 conductivity input error alarm EVT□ type]. • Available only when EEUL□□ (Conductivity input error alarm output) is selected in [EVT4 type] • Setting range: Measurement range low limit to Measurement range high limit (*1) When set to 0.00, Conductivity input error alarm is disabled. 	Measurement range low limit
E4E0T □□□□ 0	EVT4 conductivity input error alarm time when EVT□ output ON <ul style="list-style-type: none"> • Sets time to assess EVT4 conductivity input error alarm when EVT□ output is ON – which is selected in [EVT4 conductivity input error alarm EVT□ type]. • Available only when EEUL□□ (Conductivity input error alarm output) is selected in [EVT4 type] • Setting range: 0 to 10000 seconds or minutes Time unit follows the selection in [Conductivity input error alarm time unit]. When set to 0, Conductivity input error alarm is disabled. 	0 sec.
E4EC □□□□ 0.00	EVT4 conductivity input error alarm span when EVT□ output OFF <ul style="list-style-type: none"> • Sets span to assess EVT4 conductivity input error alarm when EVT□ output is OFF– which is selected in [EVT4 conductivity input error alarm EVT□ type]. • Available only when EEUL□□ (Conductivity input error alarm output) is selected in [EVT4 type] • Setting range: Measurement range low limit to Measurement range high limit (*1) When set to 0.00, Conductivity input error alarm is disabled. 	Measurement range low limit
E4ECT □□□□ 0	EVT4 conductivity input error alarm time when EVT□ output OFF <ul style="list-style-type: none"> • Sets time to assess EVT4 conductivity input error alarm when EVT□ output is OFF– which is selected in [EVT4 conductivity input error alarm EVT□ type]. • Available only when EEUL□□ (Conductivity input error alarm output) is selected in [EVT4 type] • Setting range: 0 to 10000 seconds or minutes (Time unit follows the selection in [Conductivity input error alarm time unit].) When set to 0, Conductivity input error alarm is disabled. 	0 sec.
MVZN4 □□□□ 50.0	EVT4 cycle variable range <ul style="list-style-type: none"> • Sets EVT4 cycle range to be changed. • Available when EC-L□□ (Conductivity input low limit action), EC-H□□ (Conductivity input high limit action), TEMPL□ (Temperature input low limit action) or TEMPH□ (Temperature input high limit action) is selected in [EVT4 type]. • Not available for ON/OFF control. • Setting range: 1.0 to 100.0% 	50.0%
CENT4 □□□□ 0	EVT4 cycle extended time <ul style="list-style-type: none"> • Sets time to extend EVT4 cycle. • Available when EC-L□□ (Conductivity input low limit action), EC-H□□ (Conductivity input high limit action), TEMPL□ (Temperature input low limit action) or TEMPH□ (Temperature input high limit action) is selected in [EVT4 type]. • Not available for ON/OFF control. • Setting range: 0 to 300 seconds 	0 sec.

(*1) Measurement unit and decimal point place follow the measurement range.

EVT4 Action

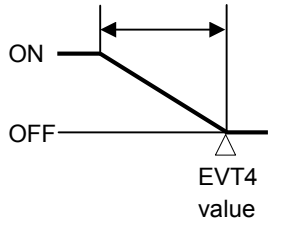
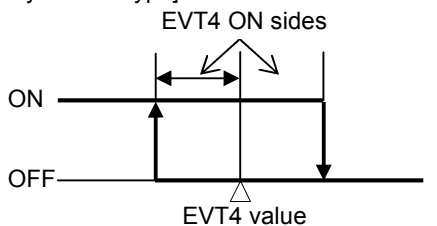
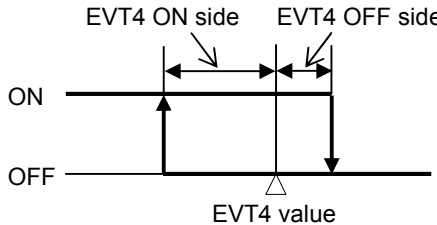
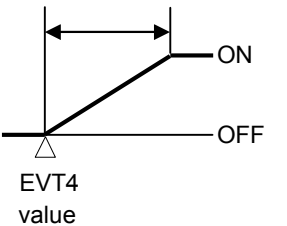
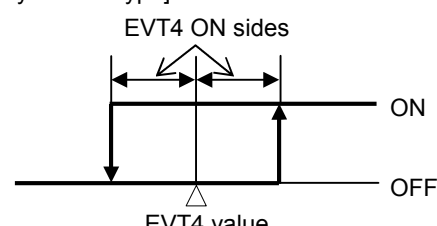
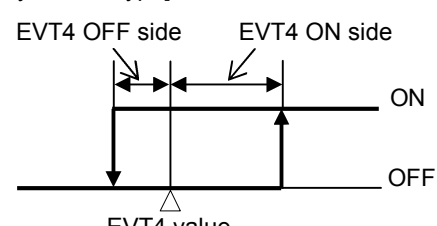
EVT4 Type	P Control Action	ON/OFF Control Action
Conductivity input low limit action, Temperature input low limit action	EVT4 proportional band 	If Medium Value is selected in [EVT4 hysteresis type]: 
		If Reference Value is selected in [EVT4 hysteresis type]: 
Conductivity input high limit action, Temperature input high limit action	EVT4 proportional band 	If Medium Value is selected in [EVT4 hysteresis type]: 
		If Reference Value is selected in [EVT4 hysteresis type]: 

(Fig. 6.7-1)

Timing chart of EVT4 output ON time and OFF time while in EVT4 output ON

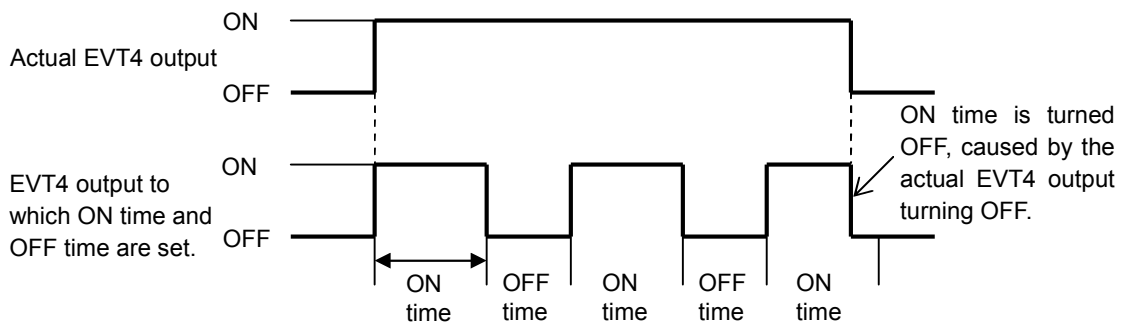

(Fig. 6.7-2)

6.8 Communication Group

Available only when C5 option is ordered.

To enter the Communication Group, follow the procedure below.

- ① **G_EC** Press the MODE key in Conductivity/Temperature Display Mode.
- ② **G_COM** Press the ▽ key as many times as necessary until the left characters appear.
- ③ **CMSL** Press the SET key.

The unit will enter the Communication Group, and the 'Communication protocol' will appear.

Character	Setting Item, Function, Setting Range	Factory Default
CMSL NOML	Communication protocol • Selects communication protocol. • NOML : Shinko protocol MODA : Modbus ASCII mode MODR : Modbus RTU mode	Shinko protocol
CMNO 00000	Instrument number • Sets the instrument number. (The instrument numbers should be set one by one when multiple instruments are connected.) • Setting range: 0 to 95	0
CMSP 9600	Communication speed • Selects a communication speed equal to that of the host computer. • 9600 : 9600 bps 19200 : 19200 bps 38400 : 38400 bps	9600 bps
CMFT 7EVN	Data bit/Parity • Selects data bit and parity. • 8NON : 8 bits/No parity 7NON : 7 bits/No parity 8EVN : 8 bits/Even 7EVN : 7 bits/Even 8ODD : 8 bits/Odd 7ODD : 7 bits/Odd	7 bits/Even
CMST 00001	Stop bit • Selects the stop bit. • 00001 : 1 bit 00002 : 2 bits	1 bit

6.9 Transmission Output Group

To enter the Transmission Output Group, follow the procedure below.

- ① **G_EC** Press the MODE key in Conductivity/Temperature Display Mode.
- ② **G_TRA** Press the key as many times as necessary until the left characters appear.
- ③ **TROS1** Press the SET key.

The unit will enter Transmission Output Group, and 'Transmission output 1 type' will appear.

Character	Setting Item, Function, Setting Range	Factory Default
TROS1 EC <input type="checkbox"/>	Transmission output 1 type <ul style="list-style-type: none"> • Selects the Transmission output 1 type. If OFF <input type="checkbox"/> (No temperature compensation) is selected in [Temperature compensation method (p.23)], and if TEMP <input type="checkbox"/> (Temperature transmission) is selected here, transmission output value differs depending on the selection in [Temperature Display when no temperature compensation (p.49)]. If OFF <input type="checkbox"/> (Unlit) or STD <input type="checkbox"/> (Reference temperature) is selected, the transmission output value will become the value set in [Reference temperature (p.23)]. If PV <input type="checkbox"/> (Measurement value) is selected, the transmission output value will be the Measurement value. • EC <input type="checkbox"/> : Conductivity transmission • TEMP <input type="checkbox"/> : Temperature transmission • MV1 <input type="checkbox"/> : EVT1 MV transmission • MV2 <input type="checkbox"/> : EVT2 MV transmission 	Conductivity transmission
TRLH1 <input type="checkbox"/> 20.00	Transmission output 1 high limit <ul style="list-style-type: none"> • Sets the Transmission output 1 high limit value. (This value corresponds to 20 mA DC output.) If Transmission output 1 high limit and low limit are set to the same value, Transmission output 1 will be fixed at 4 mA DC. • Conductivity transmission: Transmission output 1 low limit to Measurement range high limit (*1) • Temperature transmission: Transmission output 1 low limit to 100.0°C (*2) • MV transmission: Transmission output 1 low limit to 100.0% 	Conductivity transmission: 20.00 Temperature transmission: 100.0°C MV transmission: 100.0%
TRLL1 <input type="checkbox"/> 0.00	Transmission output 1 low limit <ul style="list-style-type: none"> • Sets the Transmission output 1 low limit value. (This value corresponds to 4 mA DC output.) If Transmission output 1 high limit and low limit are set to the same value, Transmission output 1 will be fixed at 4 mA DC. • Conductivity transmission: Measurement range low limit to Transmission output 1 high limit (*1) • Temperature transmission: 0.0°C to Transmission output 1 high limit (*2) • MV transmission: 0.0% to Transmission output 1 high limit 	Conductivity transmission: 0.00 Temperature transmission: 0.0°C MV transmission: 0.0%
TRCS1 BEFH <input type="checkbox"/>	Transmission output 1 status when calibrating <ul style="list-style-type: none"> • Sets the Transmission output 1 status when calibrating. • BEFH <input type="checkbox"/> : Last value HOLD (Retains and outputs the last value before conductivity calibration.) • SETH <input type="checkbox"/> : Set value HOLD (Outputs the value set in [Transmission output 1 Set value HOLD].) • PVH <input type="checkbox"/> : Measurement value (Outputs the measurement value when conductivity is calibrated.) 	Last value HOLD

(*1) Measurement unit and decimal point place follow the Measurement range.

(*2) The placement of the decimal point does not follow the selection. It is fixed.

Character	Setting Item, Function, Setting Range	Factory Default
TRSE1 [] [] [] 0.00	Transmission output 1 Set value HOLD <ul style="list-style-type: none"> Sets the Transmission output 1 Set value HOLD. Available only when SETH [] [] (Set value HOLD) is selected in [Transmission output 1 status when calibrating] Conductivity transmission: Measurement range low limit to Measurement range high limit (*1) Temperature transmission: 0.0 to 100.0°C (*2) MV transmission: 0.0 to 100.0% 	Conductivity transmission: Measurement range low limit Temperature transmission: 0.0°C MV transmission: 0.0%
TROS2 EC [] [] [] []	Transmission output 2 type <ul style="list-style-type: none"> Selects the Transmission output 2 type. If OFF [] [] [] (No temperature compensation) is selected in [Temperature compensation method (p.23)], and if TEMP [] [] (Temperature transmission) is selected here, transmission output value differs depending on the selection in [Temperature Display when no temperature compensation (p.49)]. If OFF [] [] (Unlit) or STD [] [] (Reference temperature) is selected, the unit operates based on the value set in [Reference temperature (p.23)]. If PV [] [] [] (Measurement value) is selected, the unit operates based on the Measurement value. EC [] [] [] : Conductivity transmission TEMP [] [] : Temperature transmission MV1 [] [] [] : EVT1 MV transmission MV2 [] [] [] : EVT2 MV transmission MV3 [] [] [] : EVT3 MV transmission 	Conductivity transmission
TRLH2 [] [] 20.00	Transmission output 2 high limit <ul style="list-style-type: none"> Sets the Transmission output 2 high limit value. (This value corresponds to 20 mA DC output.) If Transmission output 2 high limit and low limit are set to the same value, Transmission output 2 will be fixed at 4 mA DC. Conductivity transmission: Transmission output 2 low limit to Measurement range high limit (*1) Temperature transmission: Transmission output 2 low limit to 100.0°C (*2) MV transmission: Transmission output 2 low limit to 100.0% 	Conductivity transmission: 20.00 Temperature transmission: 100.0°C MV transmission: 100.0%
TRLL2 [] [] [] 0.00	Transmission output 2 low limit <ul style="list-style-type: none"> Sets the Transmission output 2 low limit value. (This value corresponds to 4 mA DC output.) If Transmission output 2 high limit and low limit are set to the same value, Transmission output 2 will be fixed at 4 mA DC. Conductivity transmission: Measurement range low limit to Transmission output 2 high limit (*1) Temperature transmission: 0.0°C to Transmission output 2 high limit (*2) MV transmission: 0.0% to Transmission output 2 high limit 	Conductivity transmission: 0.00 Temperature transmission: 0.0°C MV transmission: 0.0%
TRCS2 BEFH [] []	Transmission output 2 status when calibrating <ul style="list-style-type: none"> Sets the Transmission output 2 status when calibrating. BEFH [] [] [] : Last value HOLD (Retains and outputs the last value before conductivity calibration.) SETH [] [] [] : Set value HOLD (Outputs the value set in [Transmission output 2 Set value HOLD].) PVH [] [] [] : Measurement value (Outputs the measurement value when conductivity is calibrated.) 	Last value HOLD

(*1) Measurement unit and decimal point place follow the Measurement range.

(*2) The placement of the decimal point does not follow the selection. It is fixed.

Character	Setting Item, Function, Setting Range	Factory Default
TRSE2 	Transmission output 2 Set value HOLD <ul style="list-style-type: none"> • Sets the Transmission output 2 Set value HOLD. Available only when SETH (Set value HOLD) is selected in [Transmission output 2 status when calibrating] • Conductivity transmission: Measurement range low limit to Measurement range high limit (*1) Temperature transmission: 0.0 to 100.0°C (*2) MV transmission: 0.0 to 100.0% 	Conductivity transmission: Measurement range low limit Temperature transmission: 0.0°C MV transmission: 0.0%

(*1) Measurement unit and decimal point place follow the Measurement range.

(*2) The placement of the decimal point does not follow the selection. It is fixed.

6.10 Special Function Group

To enter the Special Function Group, follow the procedure below.

- ① **G_EC** Press the **MODE** key in Conductivity/Temperature Display Mode.
- ② **G_OTH** Press the **▽** key as many times as necessary until the left characters appear.
- ③ **LOCK** Press the **SET** key.

The unit will enter the Special Function Group, and the 'Set value lock' will appear.

Character	Setting Item, Function, Setting Range	Factory Default
LOCK -----	Set value lock <ul style="list-style-type: none"> • Locks the set values to prevent setting errors. • ----- (Unlock): All set values can be changed. • LOCK1 (Lock 1): None of the set values can be changed. • LOCK2 (Lock 2): Only EVT1, EVT2, EVT4, EVT4 values can be changed. • LOCK3 (Lock 3): All set values – except Sensor cell constant, Measurement unit, Measurement range, RTD type, Conductivity Zero adjustment value, Conductivity Span adjustment value, Temperature calibration value, Transmission output 1 Zero adjustment value, Transmission output 1 Span adjustment value, Transmission output 2 Zero adjustment value, Transmission output 2 Span adjustment value – can be temporarily changed. <p>However, they revert to their previous value after the power is turned off because they are not saved in the non-volatile IC memory. Do not change setting items (EVT1, EVT2, EVT4, EVT4 types). If they are changed, they will affect other setting items. Be sure to select Lock 3 when changing the set value frequently via software communication. (If a value set via software communication is the same as the value before the setting, the value will not be written in non-volatile IC memory.)</p>	Unlock
DISP DUAL	Display selection <ul style="list-style-type: none"> • Selects items to be indicated in the Conductivity Display and Temperature Display. • DUAL : Input value (Conductivity, Temperature) • EC : Conductivity • TEMP : Temperature 	Input value (Conductivity, Temperature)
INERR OFF	EVT output when input errors occur <ul style="list-style-type: none"> • If input errors occur, such as conductivity sensor is disconnected or short-circuited, EVT output can be Enabled or Disabled. • If “Enabled” is selected, EVT output will be maintained when input errors occur. • If “Disabled” is selected, EVT output will be turned OFF when input errors occur. • ON : Enabled • OFF : Disabled 	Disabled
OFDP OFF	Temperature Display when no temperature compensation <ul style="list-style-type: none"> • If OFF (No temperature compensation) is selected in [Temperature compensation method (p.23)], selects an item to be indicated in the Temperature Display. • Available when OFF (No temperature compensation) is selected in [Temperature compensation method (p.23)]. • OFF : Unlit • STD : Reference temperature • PV : Measurement value 	Unlit
M_LS SEC	Conductivity input error alarm time unit <ul style="list-style-type: none"> • Selects conductivity input error alarm time unit. • SEC : Second(s) • MIN : Minute(s) 	Second(s)

7. Calibration

Conductivity Calibration Mode, Temperature Calibration Mode and Transmission Output Adjustment Mode are described below.

7.1 Conductivity Calibration Mode

Deterioration of the 4-electrode/2-electrode conductivity sensor may cause the cell constant to change. To correct the changed cell constant, calibration is performed.

Perform Conductivity Zero adjustment first, followed by Span adjustment.

However, if **LOCK1** (Lock 1), **LOCK2** (Lock 2) or **LOCK3** (Lock 3) is selected in [Set value lock (p.49)], the instrument cannot move to Conductivity Calibration Mode.

The following outlines the procedure for conductivity calibration.

① When selecting **BEFH** (Last value HOLD) in [Transmission output 1 status when calibrating (p.46)] or in [Transmission output 2 status when calibrating (p.47)], select it while the 4-electrode/2-electrode conductivity sensor is being immersed in the solution currently calibrated.

② Do not immerse the 4-electrode/2-electrode conductivity sensor in the standard solution.

③ Press the **CAL** key in Conductivity/Temperature Display Mode.

The unit will enter Conductivity Zero adjustment in Conductivity Calibration Mode, and will indicate the following.

Display	Indication
Conductivity Display	ADJZ and conductivity are indicated alternately.
Temperature Display	Conductivity Zero adjustment value is indicated.

④ Set the Conductivity Zero adjustment value with the **▲** or **▼** key so that the conductivity becomes 0. If conductivity is 0 (zero), this adjustment is not necessary.

Setting range of the Conductivity Zero adjustment value differs depending on the measurement range. (See Table 7.1-1.)

However, it is effective within the measurement range regardless of the Conductivity Zero adjustment value.

(Table 7.1-1)

FEB-102-ECH:

Measurement Range	Conductivity Zero Adjustment Value Setting Range
0.00 to 20.00 mS/cm	-2.00 to 2.00
0.0 to 200.0 mS/cm	-20.0 to 20.0
0.0 to 500.0 mS/cm	-50.0 to 50.0
0 to 500 mS/cm	-50 to 50
0.000 to 2.000 S/m	-0.200 to 0.200
0.00 to 20.00 S/m	-2.00 to 2.00
0.00 to 50.00 S/m	-5.00 to 5.00
0.0 to 50.0 S/m	-5.0 to 5.0
0 to 2000 mS/m	-200 to 200
0.0 to 20.0 g/L	-2.0 to 2.0
0 to 200 g/L	-20 to 20
0 to 500 g/L	-50 to 50

Measurement Range		Conductivity Zero Adjustment Value Setting Range
Cell constant 10.0/cm	0.0 to 200.0 mS/cm	-20.0 to 20.0
	0.0 to 500.0 mS/cm	-50.0 to 50.0
	0 to 2000 mS/cm	-200 to 200
	0.00 to 20.00 S/m	-2.00 to 2.00
	0.00 to 50.00 S/m	-5.00 to 5.00
	0.0 to 200.0 S/m	-20.0 to 20.0
	0 to 200 g/L	-20 to 20
	0 to 500 g/L	-50 to 50
	0 to 2000 g/L	-200 to 200
Seawater salinity	0.00 to 4.00%	-0.40 to 0.40
NaCl salinity	0.00 to 20.00%	-2.00 to 2.00

FEB-102-ECM:

Cell Constant	Measurement Range	Conductivity Zero Adjustment Value Setting Range
0.01/cm	0.00 to 20.00 μ S/cm	-2.00 to 2.00
0.1/cm	0.0 to 200.0 μ S/cm	-20.0 to 20.0
1.0/cm	0 to 2000 μ S/cm	-200 to 200
0.01/cm	0.000 to 2.000 mS/m	-0.200 to 0.200
0.1/cm	0.00 to 20.00 mS/m	-2.00 to 2.00
1.0/cm	0.0 to 200.0 mS/m	-20.0 to 20.0
0.01/cm	0.0 to 20.0 mg/L	-2.0 to 2.0
0.1/cm	0 to 200 mg/L	-20 to 20
1.0/cm	0 to 2000 mg/L	-200 to 200

- ⑤ Press the **SET** key.

Conductivity Zero adjustment value will be registered, and the unit moves to in Conductivity calibration Span adjustment mode.

The following is indicated in Conductivity calibration Span adjustment mode.

Display	Indication
Conductivity Display	ADJS and conductivity are indicated alternately.
Temperature Display	Conductivity Span adjustment value is indicated.

- ⑥ Immerse the 4-electrode/2-electrode conductivity sensor in the standard solution.
- ⑦ Set the Conductivity Span adjustment value with the **▲** or **▼** key, checking the conductivity.
Conductivity Span adjustment value: 0.700 to 1.300
- ⑧ Press the **MODE** key.

Conductivity Span adjustment value will be registered, and the unit reverts to Conductivity/ Temperature Display Mode.

7.2 Temperature Calibration Mode

Temperature calibration is performed by setting the temperature calibration value.

If **OFF** (No temperature compensation) is selected in [Temperature compensation method (p.23)], Temperature Calibration Mode is not available.

The unit cannot enter Temperature Calibration Mode in the following cases:

- If **LOCK1** (Lock 1), **LOCK2** (Lock 2) or **LOCK3** (Lock 3) is selected in [Set value lock (p.49)].

When a sensor cannot be set at the exact location where measurement is desired, the resulting measured temperature may deviate from the temperature in the desired location. In this case, the desired temperature can be set for the desired location by setting a temperature calibration value. However, it is effective within the input rated range regardless of the temperature calibration value.

Temperature after calibration = Current temperature + (Temperature calibration value)

(e.g.) When current temperature is 23.5°C,

If temperature calibration value is set to 1.5°C: $23.5 + (1.5) = 25.0^{\circ}\text{C}$

If temperature calibration value is set to -1.5°C: $23.5 + (-1.5) = 22.0^{\circ}\text{C}$

Temperature calibration procedure is shown below.

- ① Press the Δ key and **CAL** key (in that order) together in Conductivity/Temperature Display Mode. The unit proceeds to Temperature Calibration Mode, and indicates the following.

Display	Indication
Conductivity Display	SO and temperature are indicated alternately.
Temperature Display	Temperature calibration value

- ② Set a temperature calibration value with the Δ or ∇ key while checking temperature. Setting range: -10.0 to 10.0°C (The placement of the decimal point does not follow the selection. It is fixed.)
- ③ Press the **MODE** key. Temperature calibration is complete, and the unit reverts to Conductivity/Temperature Display Mode.

7.3 Error Code during Temperature Calibration

For temperature sensor error or outside temperature compensation range during calibration, their corresponding error codes flash in the Temperature Display as shown below in (Table 7.3-1).

(Table 7.3-1)

Error Code	Error Type	Error Contents	Description
ERR01	Fail	Temperature Sensor Burnout	Temperature sensor lead wire is burnt out.
ERR02	Fail	Temperature Sensor Short-circuited	Temperature sensor lead wire is short-circuited.
ERR03	Error	Outside Temperature Compensation Range	Measured temperature has exceeded 110.0°C.
ERR04	Error	Outside Temperature Compensation Range	Measured temperature is less than 0.0°C.

7.4 Transmission Output 1 Adjustment Mode

Fine adjustment of Transmission output 1 is performed.

This Conductivity Meter is adjusted at the factory, however, differences may occur between the indication value of the connected equipment (recorders, etc.) and output value of this instrument. In this case, perform Transmission output 1 Zero adjustment and Span adjustment.

The unit cannot enter Transmission Output 1 Adjustment Mode in the following cases:

- During Conductivity Calibration Mode or Temperature Calibration Mode
- When **LOCK1** (Lock 1), **LOCK2** (Lock 2) or **LOCK3** (Lock 3) is selected in [Set value lock (p.49)]

The following outlines the procedure for adjustment.

- ① Press and hold the Δ key and **SET** key (in that order) together for 3 seconds in Conductivity/ Temperature Display Mode.

The unit will enter Transmission Output 1 Zero Adjustment Mode, and will indicate the following.

Display	Indication
Conductivity Display	AJZ1
Temperature Display	Transmission output 1 Zero adjustment value

- ② Set a Transmission output 1 Zero adjustment value with the Δ or ∇ key, while viewing the value indicated on the connected equipment (recorders, etc.).
Setting range: $\pm 5.00\%$ of Transmission output span

- ③ Press the **SET** key.

The unit will enter Transmission Output 1 Span Adjustment Mode, and will indicate the following.

Display	Indication
Conductivity Display	AJS1
Temperature Display	Transmission output 1 Span adjustment value

- ④ Set a Transmission output 1 Span adjustment value with the Δ or ∇ key, while viewing the value indicated on the connected equipment (recorders, etc.).
Setting range: $\pm 5.00\%$ of Transmission output span

- ⑤ Press the **MODE** key.

The unit reverts to Transmission Output 1 Zero Adjustment Mode.

Repeat steps ② to ⑤ if necessary.

- ⑥ To finish Transmission output 1 adjustment, press the **SET** key in Transmission Output 1 Span Adjustment Mode.

The unit reverts to Conductivity/Temperature Display Mode.

7.5 Transmission Output 2 Adjustment Mode

Fine adjustment of Transmission output 2 is performed.

This Conductivity Meter is adjusted at the factory, however, differences may occur between the indication value of the connected equipment (recorders, etc.) and output value of this instrument. In this case, perform Transmission output 2 Zero adjustment and Span adjustment.

The unit cannot enter Transmission Output 2 Adjustment Mode in the following cases:

- During Conductivity Calibration Mode or Temperature Calibration Mode
- When **LOCK1** (Lock 1), **LOCK2** (Lock 2) or **LOCK3** (Lock 3) is selected in [Set value lock (p.49)]

The following outlines the procedure for adjustment.

- ① Press and hold the ∇ key and **SET** key (in that order) together for 3 seconds in Conductivity/ Temperature Display Mode.

The unit will enter Transmission Output 2 Zero Adjustment Mode, and will indicate the following.

Display	Indication
Conductivity Display	AJZ2
Temperature Display	Transmission output 2 Zero adjustment value

- ② Set a Transmission output 2 Zero adjustment value with the Δ or ∇ key, while viewing the value indicated on the connected equipment (recorders, etc.).
Setting range: $\pm 5.00\%$ of Transmission output span

- ③ Press the **SET** key.

The unit will enter Transmission Output 2 Span Adjustment Mode, and will indicate the following.

Display	Indication
Conductivity Display	AJS2
Temperature Display	Transmission output 2 Span adjustment value

- ④ Set a Transmission output 2 Span adjustment value with the Δ or ∇ key, while viewing the value indicated on the connected equipment (recorders, etc.).
Setting range: $\pm 5.00\%$ of Transmission output span

- ⑤ Press the **MODE** key.

The unit reverts to Transmission Output 2 Zero Adjustment Mode.

Repeat steps ② to ⑤ if necessary.

- ⑥ To finish Transmission Output 2 Adjustment, press the **SET** key in Transmission Output 2 Span Adjustment Mode.

The unit reverts to Conductivity/Temperature Display Mode.

8. Measurement

8.1 Starting Measurement

After mounting to the control panel, wiring, setup and calibration are complete, turn the power switch ON. For approx. 4 seconds after the power switch is turned ON, the input types are indicated in the Conductivity Display and Temperature Display.

Indication differs depending on the model as follows.

FEB-102-ECH:

Conductivity Display	Item Selected in [Measurement Unit (p.20)]	Temperature Display
CONV <input type="checkbox"/>	Conductivity (mS/cm)	PT100 <input type="checkbox"/> or PT1000
SI <input type="checkbox"/>	Conductivity (S/m, mS/m)	
SEA <input type="checkbox"/>	Seawater salinity (%)	
SALT <input type="checkbox"/>	NaCl salinity (%)	
TDS <input type="checkbox"/>	TDS conversion (g/L)	

FEB-102-ECM:

Conductivity Display	Item Selected in [Measurement Unit (p.20)]	Temperature Display
CONV <input type="checkbox"/>	Conductivity (μ S/cm)	PT100 <input type="checkbox"/> or PT1000
SI <input type="checkbox"/>	Conductivity (mS/m)	
TDS <input type="checkbox"/>	TDS conversion (mg/L)	

After that, measurement starts, indicating the item selected in [Display selection] or [Temperature Display when no temperature compensation (p.49)].

8.2 Error Code during Measurement

For temperature sensor error or outside temperature compensation range during measurement, their corresponding error codes flash in the Temperature Display as shown below in (Table 8.2-1).

(Table 8.2-1)

Error Code	Error Type	Error Contents	Description
ERR01 <input type="checkbox"/>	Fail	Temperature Sensor Burnout	Temperature sensor lead wire is burnt out.
ERR02 <input type="checkbox"/>	Fail	Temperature Sensor Short-circuited	Temperature sensor lead wire is short-circuited.
ERR03 <input type="checkbox"/>	Error	Outside Temperature Compensation Range	Measured temperature has exceeded 110.0°C.
ERR04 <input type="checkbox"/>	Error	Outside Temperature Compensation Range	Measured temperature is less than 0.0°C.

8.3 Setting EVT1, EVT2, EVT3, EVT4 Values

EVT1 to EVT4 values are set in Simple Setting Mode.

These EVT1 to EVT4 values correspond to those in EVT1 to EVT4 Groups.

To enter Simple Setting Mode, follow the procedure below.

- ① **ESV1** Press the **SET** key in Conductivity/Temperature Display Mode.
“EVT1 value” will be indicated.
- ② Set each setting item with the **▲** or **▼** key, and register the value with the **SET** key.

Character	Setting Item, Function, Setting Range	Factory Default
ESV1 <input type="checkbox"/> <input type="checkbox"/> 0.00	EVT1 value <ul style="list-style-type: none"> • Sets EVT1 value. • Available when EC-L <input type="checkbox"/> (Conductivity input low limit action), EC-H <input type="checkbox"/> (Conductivity input high limit action), TEMPL <input type="checkbox"/> (Temperature input low limit action) or TEMPH <input type="checkbox"/> (Temperature input high limit action) is selected in [EVT1 type]. • Setting range: Conductivity input: Measurement range low limit to Measurement range high limit (*1) Temperature input: 0.0 to 100.0°C (*2) 	Conductivity input: Measurement range low limit Temperature input: 0.0°C
ESV2 <input type="checkbox"/> <input type="checkbox"/> 0.00	EVT2 value <ul style="list-style-type: none"> • Sets EVT2 value. • Available when EC-L <input type="checkbox"/> (Conductivity input low limit action), EC-H <input type="checkbox"/> (Conductivity input high limit action), TEMPL <input type="checkbox"/> (Temperature input low limit action) or TEMPH <input type="checkbox"/> (Temperature input high limit action) is selected in [EVT1 type]. • Setting range: Conductivity input: Measurement range low limit to Measurement range high limit (*1) Temperature input: 0.0 to 100.0°C (*2) 	Conductivity input: Measurement range low limit Temperature input: 0.0°C
ESV3 <input type="checkbox"/> <input type="checkbox"/> 0.00	EVT3 value <ul style="list-style-type: none"> • Sets EVT3 value. Available only when EVT3 or EVT4 is ordered. Available when EC-L <input type="checkbox"/> (Conductivity input low limit action), EC-H <input type="checkbox"/> (Conductivity input high limit action), TEMPL <input type="checkbox"/> (Temperature input low limit action) or TEMPH <input type="checkbox"/> (Temperature input high limit action) is selected in [EVT1 type]. • Setting range: Conductivity input: Measurement range low limit to Measurement range high limit (*1) Temperature input: 0.0 to 100.0°C (*2) 	Conductivity input: Measurement range low limit Temperature input: 0.0°C
ESV4 <input type="checkbox"/> <input type="checkbox"/> 0.00	EVT4 value <ul style="list-style-type: none"> • Sets EVT4 value. Available only when EVT4 is ordered. Available when EC-L <input type="checkbox"/> (Conductivity input low limit action), EC-H <input type="checkbox"/> (Conductivity input high limit action), TEMPL <input type="checkbox"/> (Temperature input low limit action) or TEMPH <input type="checkbox"/> (Temperature input high limit action) is selected in [EVT1 type]. • Setting range: Conductivity input: Measurement range low limit to Measurement range high limit (*1) Temperature input: 0.0 to 100.0°C (*2) 	Conductivity input: Measurement range low limit Temperature input: 0.0°C

(*1) Measurement unit and decimal point place follow the Measurement range.

(*2) The placement of the decimal point does not follow the selection. It is fixed.

- ③ Press the **MODE** key. The unit reverts to Conductivity/Temperature Display Mode.

8.4 EVT1, EVT2, EVT3, EVT4 Outputs

When **EC-L** (Conductivity input low limit action), **EC-H** (Conductivity input high limit action), **TEMP-L** (Temperature input low limit action) or **TEMP-H** (Temperature input high limit action) is selected in [EVT1 type (p.25)], EVT1 action will be activated as follows.

The same applies to EVT2, EVT3 and EVT4 output.

• EVT1 Action

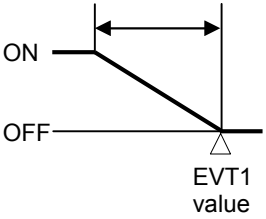
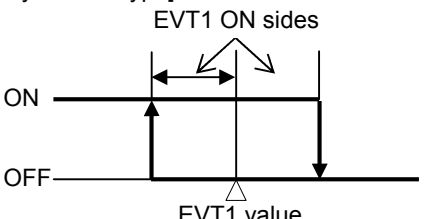
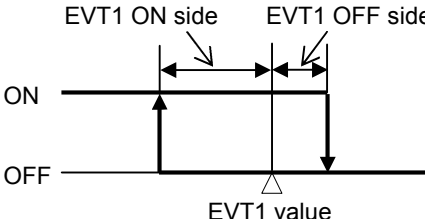
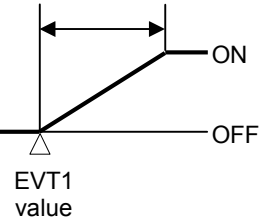
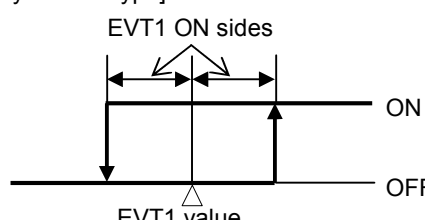
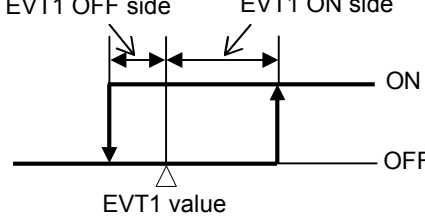
EVT1 Type	P Control Action	ON/OFF Control Action
Conductivity input low limit action, Temperature input low limit action	EVT1 proportional band 	If Medium Value is selected in [EVT1 hysteresis type]: 
		If Reference Value is selected in [EVT1 hysteresis type]: 
Conductivity input high limit action, Temperature input high limit action	EVT1 proportional band 	If Medium Value is selected in [EVT1 hysteresis type]: 
		If Reference Value is selected in [EVT1 hysteresis type]: 

(Fig. 8.4-1)

• P Control Action

Within the proportional band, the manipulated variable is output in proportion to the deviation between the EVT1 value and measurement value.

EVT1 Type	Description
Conductivity input low limit action, Temperature input low limit action	If measurement value is lower than [EVT1 value – EVT1 proportional band], EVT1 output is turned ON. If measurement value enters within the proportional band, EVT1 output is turned ON/OFF in EVT1 proportional cycles. If measurement value exceeds EVT1 value, EVT1 output is turned OFF.
Conductivity input high limit action, Temperature input high limit action	If measurement value is higher than [EVT1 value + EVT1 proportional band], EVT1 output is turned ON. If measurement value enters within the proportional band, EVT1 output is turned ON/OFF in EVT1 proportional cycles. If measurement value drops below EVT1 value, EVT1 output is turned OFF.

• **ON/OFF Control Action**

EVT1 Type	Description
Conductivity input low limit action, Temperature input low limit action	If measurement value is lower than EVT1 value, EVT1 output is turned ON. If measurement value exceeds the EVT1 value, EVT1 output is turned OFF.
Conductivity input high limit action, Temperature input high limit action	If measurement value is higher than EVT1 value, EVT1 output is turned ON. If measurement value drops below the EVT1 value, EVT1 output is turned OFF.

If ON and OFF time are set in [Output ON/OFF Time when EVT1 Output ON (p.27)], and when EVT1 output is turned ON, EVT1 output is turned ON/OFF in EVT1 proportional cycles.

Timing chart of Output ON time and OFF time while in EVT1 output ON

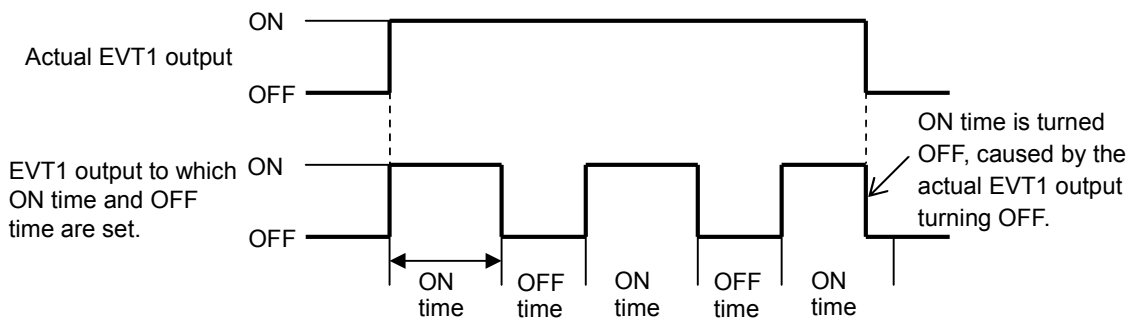

(Fig. 8.4-2)

EVT output status, when input errors occur, differs depending on the selection in [EVT output when input errors occur (p.49)].

- If **ON** (Enabled) is selected, EVT output will be maintained when input errors occur.
- If **OFF** (Disabled) is selected, EVT output will be turned OFF when input errors occur.

8.5 Error Output

If **EROUT** (Error output) is selected in [EVT1 type (p.25)], and if the error type is Error in (Table 8.5-1), EVT1 output will be turned ON.

The same applies to EVT2, EVT3 and EVT4.

(Table 8.5-1)

Error Code	Error Type	Error Contents	Description
ERR01	Fail	Temperature Sensor Burnout	Temperature sensor lead wire is burnt out.
ERR02	Fail	Temperature Sensor Short-circuited	Temperature sensor lead wire is short-circuited.
ERR03	Error	Outside Temperature Compensation Range	Measured temperature has exceeded 110.0°C.
ERR04	Error	Outside Temperature Compensation Range	Measured temperature is less than 0.0°C.

8.6 Fail Output

If **FAIL** (Fail output) is selected in [EVT1 type (p.25)], and if the error type is Fail in (Table 8.5-1), EVT1 output will be turned ON.

The same applies to EVT2, EVT3 and EVT4.

8.7 Conductivity Input Error Alarm

Conductivity input error alarm is used for detecting actuator trouble.

Even if conductivity input error alarm time has elapsed, and if conductivity input does not become higher than conductivity input error alarm span, the unit assumes that actuator trouble has occurred, and writes Status flag 2.

In Serial communication, status can be read by reading Status flag 2 (EVT1, EVT2, EVT3, EVT4 output flags).

EVT1 output is turned ON when **EEUL** (Conductivity input error alarm output) is selected in [EVT1 type (p25)].

The same applies to EVT2, EVT3 and EVT4.

Conductivity input error alarm is disabled in the following cases.

- During Conductivity Calibration Mode or Temperature Calibration Mode
- When Conductivity input error alarm time is set to 0 seconds (minutes), or Conductivity input error alarm span is set to 0.00.

8.8 Cycle Automatic Variable Function

If deviation between EVT value and measured value enters EVT cycle variable range, the proportional cycle will be automatically extended in accordance with the deviation.

Proportional action OFF time will be extended, and ON / OFF ratio will be adjusted.

However, if EVT cycle extended time is set to 0 (zero) seconds, this function will be disabled.

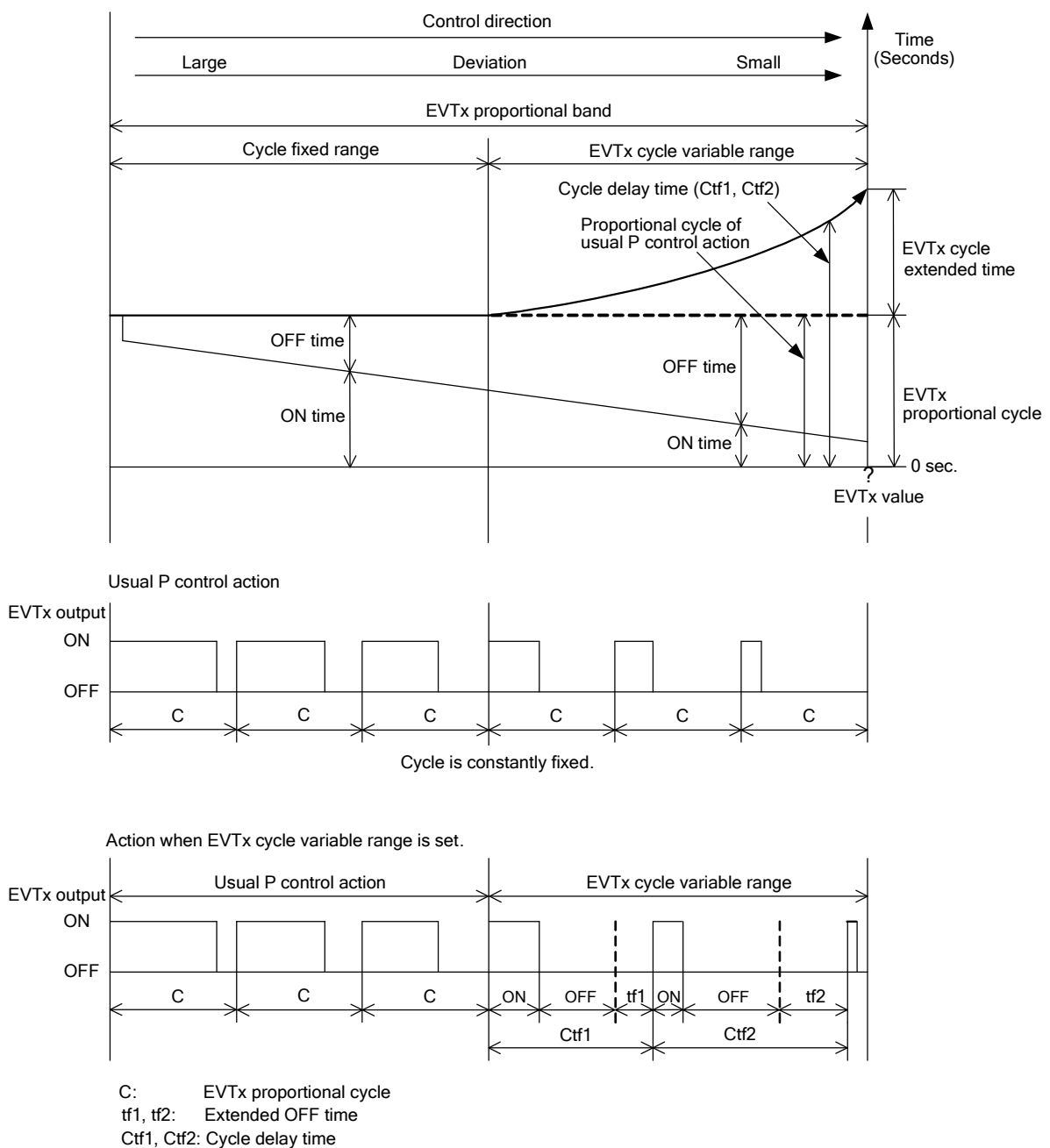

EVTx: EVT1, EVT2, EVT3, EVT4

(Fig. 8.8-1)

8.9 Transmission Output

Converting conductivity, temperature or MV to analog signal every input sampling period, outputs in current.

If **OFF** (No temperature compensation) is selected in [Temperature compensation method (p.23)], and if **TEMP** (Temperature transmission) is selected in [Transmission output 1 type (p.46)], Transmission output 1 value differs depending on the selection in [Temperature Display when no temperature compensation (p.49)].

If **OFF** (Unlit) or **STD** (Reference temperature) is selected, the value set in [Reference temperature (p.23)] will be output.

If **PV** (Measurement value) is selected, the Measurement value will be output.

If Transmission output 1 high limit and low limit are set to the same value, Transmission output 1 will be fixed at 4 mA DC.

The same applies to Transmission output 2.

Resolution	12000
Current	4 to 20 mA DC (Load resistance: Max 550 Ω)
Output accuracy	Within ±0.3% of Transmission output span

9. Specifications

9.1 Standard Specifications

Rating

Rated Scale	FEB-102-ECH				
	Input		Scale Range	Resolution	
	Conductivity	Cell constant 1.0/cm	0.00 to 20.00 mS/cm	0.01 mS/cm	
			0.0 to 200.0 mS/cm	0.1 mS/cm	
			0.0 to 500.0 mS/cm	0.1 mS/cm	
			0 to 500 mS/cm	1 mS/cm	
			0.000 to 2.000 S/m	0.001 S/m	
			0.00 to 20.00 S/m	0.01 S/m	
			0.00 to 50.00 S/m	0.01 S/m	
			0.0 to 50.0 S/m	0.1 S/m	
			0 to 2000 mS/m	1 mS/m	
			0.0 to 20.0 g/L	0.1 g/L	
			0 to 200 g/L	1 g/L	
			0 to 500 g/L	1 g/L	
			Cell constant 10.0/cm	0.0 to 200.0 mS/cm	0.1 mS/cm
				0.0 to 500.0 mS/cm	0.1 mS/cm
	0 to 2000 mS/cm	1 mS/cm			
	0.00 to 20.00 S/m	0.01 S/m			
	0.00 to 50.00 S/m	0.01 S/m			
	0.0 to 200.0 S/m	0.1 S/m			
	0 to 200 g/L	1 g/L			
	0 to 500 g/L	1 g/L			
	0 to 2000 g/L	1 g/L			
	Seawater salinity		0.00 to 4.00 %	0.01 %	
	NaCl salinity		0.00 to 20.00 %	0.01 %	
	Temperature Compensation (*)	Pt100	0.0 to 100.0 °C	0.1 °C	
		Pt1000			
(*) Temperature compensation: Decimal point place is selectable					
FEB-102-ECM					
Input		Cell Constant	Scale Range	Resolution	
Conductivity		0.01/cm	0.00 to 20.00 μS/cm	0.01 μS/cm	
		0.1/cm	0.0 to 200.0 μS/cm	0.1 μS/cm	
		1.0/cm	0 to 2000 μS/cm	0.1 μS/cm	
		0.01/cm	0.000 to 2.000 mS/m	0.001 mS/m	
		0.1/cm	0.00 to 20.00 mS/m	0.01 mS/m	
		1.0/cm	0.0 to 200.0 mS/m	0.1 mS/m	
		0.01/cm	0.0 to 20.0 mg/L	0.1 mg/L	
		0.1/cm	0 to 200 mg/L	1 mg/L	
		1.0/cm	0 to 2000 mg/L	1 mg/L	
Temperature Compensation (*)	Pt100	0.0 to 100.0 °C	0.1 °C		
	Pt1000				
(*) Temperature compensation: Decimal point place is selectable					
Input	FEB-102-ECH 4-electrode conductivity sensor (Temperature element: Pt100 or Pt1000)				
	FEB-102-ECM 2-electrode conductivity sensor (Temperature element: Pt100 or Pt1000)				
Supply Voltage	100 to 240 V AC 50/60Hz Allowable voltage fluctuation range: 85 to 264 V AC				

General Structure

External Dimensions	239.5 x 190 x 75 mm(W x H x D)		
Mounting	Wall mounted		
Case	Material: Polycarbonate, Color: Metallic gray		
Panel	Membrane sheet		
Drip-proof/Dust-proof	IP65		
Indication Structure	LCD Display		
	Conductivity Display	Indicates conductivity. Indicates the setting item or calibration item in setting mode or calibration mode.	
	Temperature Display	Indicates temperature. Indicates the set value or calibration value in setting mode or calibration mode.	
	Model display	Indicates the model.	
	Action indicator	EV1	Indicated when EVT1 output (Contact output 1) is ON.
		EV2	Indicated when EVT2 output (Contact output 2) is ON.
		EV3	Indicated when EVT3 output (Contact output 3) is ON. (When EVT3 or EVT4 option is ordered)
EV4		Indicated when EVT4 output (Contact output 4) is ON. (When EVT4 option is ordered)	
T/R		Indicated while in Serial communication TX output (transmitting) (When C5 option is ordered)	
Setting Structure	Setting method: Input system using membrane sheet key		

Indication Performance

Repeatability	FEB-102-ECH Conductivity: $\pm 0.5\%$ of Measurement span Salinity: $\pm 1\%$ of Measurement span TDS conversion: $\pm 1.5\%$ of Measurement span
	FEB-102-ECM Conductivity: $\pm 0.5\%$ of Measurement span TDS conversion: $\pm 1.5\%$ of Measurement span
Linearity	FEB-102-ECH Conductivity: $\pm 0.5\%$ of Measurement span Salinity: $\pm 1\%$ of Measurement span TDS conversion: $\pm 1.5\%$ of Measurement span
	FEB-102-ECM Conductivity: $\pm 0.5\%$ of Measurement span TDS conversion: $\pm 1.5\%$ of Measurement span
Temperature Indication Accuracy	$\pm 1^\circ\text{C}$
Input Sampling Period	250 ms (2 inputs)
Time Accuracy	Within $\pm 1\%$ of setting time

Standard Functions

<p>Conductivity Calibration</p>	<p>Perform Conductivity Zero adjustment first, followed by Span adjustment. If LOCK1 (Lock 1), LOCK2 (Lock 2) or LOCK3 (Lock 3) is selected in [Set value lock (p.49)], the unit cannot enter Conductivity Calibration Mode. In Conductivity Zero adjustment, adjustment is performed so that conductivity becomes 0, without immersing the 4-electrode/2-electrode conductivity sensor in the standard solution. In Conductivity Span adjustment, the 4-electrode/2-electrode conductivity sensor is immersed and adjustment is performed while checking conductivity. However, it is effective within the measurement range regardless of the adjustment value.</p>
<p>Temperature Calibration</p>	<p>When a sensor cannot be set at the exact location where measurement is desired, the resulting measured temperature may deviate from the temperature in the desired location. In this case, the desired temperature can be set for the desired location by setting a temperature calibration value. However, it is effective within the input rated range regardless of the temperature calibration value.</p>
<p>TDS Conversion</p>	<p>TDS stands for Total Dissolved Solids. Conductivity of a solution results from the amount of salt, minerals or dissolved gas. Conductivity is an index indicating total amount of substance in a solution, and TDS indicates only the amount of all dissolved solid substances. TDS can be used correctly to compare the two solutions in which one ingredient, such as NaCl, is included. However, for comparison between a solution in which one ingredient such as NaCl is included and the other solution in which more than one ingredient is included, TDS error will occur. TDS and conductivity are expressed with the following formula.</p> <p>FEB-102-ECH:</p> <p>For Conductivity of SI unit (S/m): $\text{TDS (g/L)} = \text{L (S/m)} \times \text{K} \times 10$ $\text{TDS (g/L)} = \text{L (mS/m)} \times \text{K}/100$ For Conductivity of older unit (mS/cm): $\text{TDS (g/L)} = \text{L (mS/cm)} \times \text{K}$ K: TDS conversion factor L: Conductivity</p> <p>FEB-102-ECM:</p> <p>For Conductivity of SI unit (mS/m): $\text{TDS (mg/L)} = \text{L (mS/m)} \times \text{K} \times 10$ For Conductivity of older unit ($\mu\text{S/cm}$): $\text{TDS (mg/L)} = \text{L } (\mu\text{S/cm}) \times \text{K}$ K: TDS conversion factor L: Conductivity</p>

EVT□ output		
Setting accuracy	Same as Indication Accuracy	
Output action	P control: When proportional band is set to any value, except 0 (zero). ON/OFF control: When proportional band is set to 0 (zero).	
	EVT□ proportional band	Conductivity input 0 to Measurement span (*1)
		Temperature input 0.0 to 100.0°C (*2)
	EVT□ proportional cycle	1 to 300 seconds
	EVT□ ON side, EVT□ OFF side	Conductivity input 0 to 20% of Measurement range high limit (*1)
		Temperature input 0.0 to 10.0°C (*2)
	Output high limit, low limit	0 to 100 %
(*1) Measurement unit and decimal point place follow the Measurement range. (*2) The placement of the decimal point does not follow the selection. It is fixed.		
Type	One type can be selected from the following with the keypad. <ul style="list-style-type: none"> • No action • Conductivity input low limit action • Conductivity input high limit action • Temperature input low limit action • Temperature input high limit action • Error output • Fail output • Conductivity input error alarm output 	
Output	Relay contact 1a	
	Control capacity	3A 250 V AC (Resistive load) 1A 250 V AC (Inductive load $\cos\phi=0.4$)
	Electrical life	100,000 cycles
EVT□ ON delay time	0 to 10000 seconds	
EVT□ OFF delay time	0 to 10000 seconds	
Output ON time/ OFF time when EVT□ output ON	If Output ON time and OFF time are set, EVT output can be turned ON/OFF in a configured cycle when EVT output is ON.	
Cycle Automatic Variable Function	If deviation between EVT□ value and measured value enters EVT□ cycle variable range, the proportional cycle will be automatically extended in accordance with the deviation. Proportional action OFF time will be extended, and ON / OFF ratio will be adjusted. However, if EVT□ cycle extended time is set to 0 (zero) seconds, this function will be disabled.	
Conductivity input error alarm	Detects actuator trouble. Even if conductivity input error alarm time has elapsed, and if conductivity input does not become higher than conductivity input error alarm span, the unit assumes that actuator trouble has occurred, and writes Status flag 2. In Serial communication, status can be read by reading Status flag 2 (EVT1, EVT2, EVT3, EVT4 output flags). EVT1 output is turned ON when EEUL□□ (Conductivity input error alarm output) is selected in [EVT1 type (p. 25)]. The same applies to EVT2, EVT3 and EVT4. Conductivity input error alarm is disabled in the following cases. <ul style="list-style-type: none"> • During Conductivity Calibration Mode or Temperature Calibration Mode • When Conductivity input error alarm time is set to 0 seconds (minutes), or Conductivity input error alarm span is set to 0.00. 	

Transmission Output 1, 2	<p>Converting conductivity, temperature or MV to analog signal every input sampling period, and outputs the value in current.</p> <p>If OFF (No temperature compensation) is selected in [Temperature compensation method (p.23)], and if TEMP (Temperature transmission) is selected in [Transmission output 1 type (p.46)], transmission output 1 value differs depending on the selection in [Temperature Display when no temperature compensation (p.49)].</p> <p>If OFF (Unlit) or STD (Reference temperature) is selected, the unit operates based on the value set in [Reference temperature (p.23)].</p> <p>If PV (Measurement value) is selected, the unit operates based on the measurement value.</p> <p>If Transmission output 1 high limit and low limit are set to the same value, Transmission output 1 will be fixed at 4 mA DC.</p> <p>The same applies to Transmission output 2.</p>	
	Resolution	12000
	Current	4 to 20 mA DC (Load resistance: Max 550 Ω)
	Output accuracy	Within ±0.3% of Transmission output span
Transmission output adjustment	For Transmission output 1 and 2, fine adjustment of Transmission output can be performed via Transmission output Zero and Span adjustment.	
Transmission output status when calibrating	For Transmission output 1 and 2, Transmission output status when calibrating conductivity can be selected.	
	Last value HOLD	Retains and outputs the last value before conductivity calibration.
	Set value HOLD	Outputs the value set in [Transmission output 1, 2 Set value HOLD].
	Measurement value	Outputs the measurement value when calibrating conductivity.

Insulation/Dielectric Strength

Circuit Insulation Configuration	<p style="text-align: center;">Electrically insulated</p> <p style="text-align: center;">: When option is ordered.</p> <p>Insulation resistance: 10 MΩ or more, at 500 V DC</p>
Dielectric Strength	<p>Between power terminal - ground (GND): 1.5 kV AC for 1 minute</p> <p>Between input terminal - ground (GND): 1.5 kV AC for 1 minute</p> <p>Between input terminal - power terminal: 1.5 kV AC for 1 minute</p>

Attached Functions

Set Value Lock	<p>Lock 1: None of the set values can be changed. Lock 2: Only EVT1, EVT2, EVT3, EVT4 values can be changed. Lock 3: All set values – except Sensor cell constant, Measurement unit, Measurement range, RTD type, Conductivity Zero adjustment value, Conductivity Span adjustment value, Temperature calibration value, Transmission output 1 Zero adjustment value, Transmission output 1 Span adjustment value, Transmission output 2 Zero adjustment value, Transmission output 2 Span adjustment value – can be temporarily changed. However, they revert to their previous value after the power is turned off because they are not saved in the non-volatile IC memory.</p>						
Conductivity Input Sensor Correction	<p>Conductivity measured by the conductivity sensor may deviate from the conductivity in the measured location. In this case, desired conductivity can be obtained by adding a sensor correction value. However, it is effective within the measurement range regardless of the sensor correction value.</p>						
Outside Measurement Range	<p>FEB-102-ECH</p> <ul style="list-style-type: none"> When Conductivity measured value, Salinity or TDS conversion factor is outside the measurement range, indicates the following. 						
	<table border="1" style="width: 100%; border-collapse: collapse;"> <thead> <tr> <th style="width: 50%; text-align: center;">Conductivity Display</th> <th style="width: 50%; text-align: center;">Temperature Display</th> </tr> </thead> <tbody> <tr> <td>Conductivity high limit, Salinity high limit or TDS conversion high limit is flashing.</td> <td>Temperature measured value</td> </tr> </tbody> </table>	Conductivity Display	Temperature Display	Conductivity high limit, Salinity high limit or TDS conversion high limit is flashing.	Temperature measured value		
	Conductivity Display	Temperature Display					
	Conductivity high limit, Salinity high limit or TDS conversion high limit is flashing.	Temperature measured value					
	<p>• When temperature measured value is outside the measurement range, indicates the following.</p>						
	<table border="1" style="width: 100%; border-collapse: collapse;"> <thead> <tr> <th style="width: 50%; text-align: center;">Conductivity Display</th> <th style="width: 50%; text-align: center;">Temperature Display</th> </tr> </thead> <tbody> <tr> <td>Conductivity measured value</td> <td>Exceeding 110.0°C: ERR03 □</td> </tr> <tr> <td>Conductivity measured value</td> <td>Less than 0.0°C: ERR04 □</td> </tr> </tbody> </table>	Conductivity Display	Temperature Display	Conductivity measured value	Exceeding 110.0°C: ERR03 □	Conductivity measured value	Less than 0.0°C: ERR04 □
	Conductivity Display	Temperature Display					
	Conductivity measured value	Exceeding 110.0°C: ERR03 □					
	Conductivity measured value	Less than 0.0°C: ERR04 □					
	<p>FEB-102-ECM</p> <ul style="list-style-type: none"> When Conductivity measured value or TDS conversion factor is outside the measurement range, indicates the following. 						
	<table border="1" style="width: 100%; border-collapse: collapse;"> <thead> <tr> <th style="width: 50%; text-align: center;">Conductivity Display</th> <th style="width: 50%; text-align: center;">Temperature Display</th> </tr> </thead> <tbody> <tr> <td>Conductivity or TDS conversion high limit is flashing.</td> <td>Temperature measured value</td> </tr> </tbody> </table>	Conductivity Display	Temperature Display	Conductivity or TDS conversion high limit is flashing.	Temperature measured value		
	Conductivity Display	Temperature Display					
	Conductivity or TDS conversion high limit is flashing.	Temperature measured value					
	<p>• When temperature measured value is outside the measurement range</p>						
<table border="1" style="width: 100%; border-collapse: collapse;"> <thead> <tr> <th style="width: 50%; text-align: center;">Conductivity Display</th> <th style="width: 50%; text-align: center;">Temperature Display</th> </tr> </thead> <tbody> <tr> <td>Conductivity measured value</td> <td>Exceeding 110.0°C: ERR03 □</td> </tr> <tr> <td>Conductivity measured value</td> <td>Less than 0.0°C: ERR04 □</td> </tr> </tbody> </table>	Conductivity Display	Temperature Display	Conductivity measured value	Exceeding 110.0°C: ERR03 □	Conductivity measured value	Less than 0.0°C: ERR04 □	
Conductivity Display	Temperature Display						
Conductivity measured value	Exceeding 110.0°C: ERR03 □						
Conductivity measured value	Less than 0.0°C: ERR04 □						
Power Failure Countermeasure	The setting data is backed up in the non-volatile IC memory.						
Self-diagnosis	The CPU is monitored by a watchdog timer, and if an abnormal status is found on the CPU, the instrument is switched to warm-up status.						

Warm-up Indication	For approx. 4 seconds after the power switch is turned ON, the input types are indicated in the Conductivity Display and Temperature Display. FEB-102-ECH:		
	Conductivity Display	Item Selected in [Measurement Unit (p.20)]	Temperature Display
	CONV <input type="checkbox"/>	Conductivity (mS/cm)	PT100 <input type="checkbox"/> or PT1000
	SI <input type="checkbox"/>	Conductivity (S/m, mS/m)	
	SEA <input type="checkbox"/>	Seawater salinity (%)	
	SALT <input type="checkbox"/>	NaCl salinity (%)	
	TDS <input type="checkbox"/>	TDS conversion factor (g/L)	
	FEB-102-ECM:		
	Conductivity Display	Item Selected in [Measurement Unit (p.20)]	Temperature Display
	CONV <input type="checkbox"/>	Conductivity (μ S/cm)	PT100 <input type="checkbox"/> or PT1000
SI <input type="checkbox"/>	Conductivity (mS/m)		
TDS <input type="checkbox"/>	TDS conversion factor (mg/L)		
Display Selection	Selects items to be indicated in the Conductivity Display and Temperature Display. <ul style="list-style-type: none"> • Input value (Conductivity, temperature) • Conductivity • Temperature 		
Temperature Display when No Temperature Compensation	When OFF <input type="checkbox"/> (No temperature compensation) is selected in [Temperature compensation method (p.23)], selects an item to be indicated in the Temperature Display. <ul style="list-style-type: none"> • Unlit: Temperature Display is unlit. • Reference temperature: Indicates the value set in [Reference temperature (p.23)]. • Measurement value: Indicates the measurement value in the Temperature Display. 		
Cable Length Correction	If 2WIRE <input type="checkbox"/> (2-wire type) is selected in [Pt100 input wire type (p.23)], and if sensor cable is too long, temperature measurement error will occur due to cable resistance. This can be corrected by setting the Cable length correction value and Cable cross-section area.		

Error Code

Error Code	For temperature sensor error or outside temperature compensation range during measurement or calibration, their corresponding error codes flash in the Temperature Display.			
	Error Code	Error Type	Error Contents	Description
	ERR01 <input type="checkbox"/>	Fail	Temperature Sensor Burnout	Temperature sensor lead wire is burnt out.
	ERR02 <input type="checkbox"/>	Fail	Temperature Sensor Short-circuited	Temperature sensor lead wire is short-circuited.
	ERR03 <input type="checkbox"/>	Error	Outside Temperature Compensation Range	Measured temperature has exceeded 110.0°C.
ERR04 <input type="checkbox"/>	Error	Outside Temperature Compensation Range	Measured temperature is less than 0.0°C.	

Other

Power Consumption	Approx. 10 VA
Ambient Temperature	-20 to 50 °C (Indication accuracy is applicable to 0 to 50 °C range only. Direct sunlight must be avoided.)
Ambient Humidity	35 to 95 %RH (non-condensing)
Weight	Approx. 950 g
Environmental Specification	RoHS directive compliant

9.2 Optional Specifications

Serial Communication (Option code: C5)

Serial Communication	The following operations can be carried out from an external computer. (1) Reading and setting of various set values (2) Reading of the conductivity, salinity, temperature or its status (3) Function change and adjustment (4) Reading and setting of user save area			
Cable Length	1.2 km (Max), Cable resistance value: Within 50 Ω (Terminators are not necessary, but if used, use 120 Ω or more on one side.)			
Communication Line	EIA RS-485			
Communication Method	Half-duplex communication			
Communication Speed	9600, 19200, 38400 bps (Selectable by keypad)			
Synchronization Method	Start-stop synchronization			
Code Form	ASCII, binary			
Communication Protocol	Shinko protocol, Modbus ASCII, Modbus RTU (Selectable by keypad)			
Data Bit/Parity	8-bits/No parity, 7-bits/No parity, 8-bits/Even, 7-bits/Even, 8-bits/Odd, 7-bits/Odd (Selectable by keypad)			
Stop Bit	1 bit , 2 bits (Selectable by keypad)			
Error Correction	Command request repeat system			
Error Detection	Parity check, Checksum (Shinko protocol), LRC (Modbus protocol ASCII), CRC-16 (Modbus protocol RTU)			
Data Format	Communication Protocol	Shinko Protocol	Modbus ASCII	Modbus RTU
	Start bit	1 bit	1 bit	1 bit
	Data bit	7 bits	7 bits	8 bits
	Parity	Even	Even (No parity, Odd) Selectable	No parity (Even, Odd) Selectable
	Stop bit	1 bit	1 bit (2 bits) Selectable	1 bit (2 bits) Selectable

EVT3, EVT4 Outputs (Contact outputs 3, 4) (Option Code: EVT3 or EVT4)

EVT3, EVT4 Outputs (Contact outputs 3, 4)	Same as EVT□ output (p.64)
---	----------------------------















10. Troubleshooting

If any malfunction occurs, refer to the following items after checking that power switch of the FEB-102-EC□ is turned ON.

10.1 Indication

Problem	Possible Cause	Solution
Indication of the Conductivity Display or Temperature Display is unstable or irregular.	Electrode sensor terminal screws have become loose.	Tighten the screws securely.
	Electrical insulation of electrode sensor terminals is deteriorating.	Clean the terminals with alcohol, and dry completely.
	The electrode is not clean.	Rinse the electrode.
	Air bubbles are attached to the electrode.	Make sure there are no bubbles in the measurement solution.
	The electrode has not been placed in the measurement solution.	Install the electrode in the measurement solution, maintaining a consistent volume.
	There may be equipment that interferes with or makes noise near the FEB-102-EC□.	Keep FEB-102-EC□ clear of any potentially disruptive equipment.
	Conductivity calibration and temperature calibration may not have finished.	Perform conductivity calibration and temperature calibration.
	RTD type might not be selected correctly.	Select a correct RTD type.
	Temperature compensation method may not be selected correctly.	Select a correct temperature compensation method.
	Specification of conductivity sensor may not be suitable.	Replace the sensor with a suitable specification.
Temperature Display is unlit.	OFF □□□ (unlit) is selected in [Temperature Display when no temperature compensation (p.49)].	Select STD □□□ (Reference temperature) or PV □□□□ (Measurement value).
[ERR01] □ is flashing in Temperature Display.	Temperature sensor lead wire is burnt out.	Replace the conductivity sensor.
[ERR02] □ is flashing in Temperature Display.	Temperature sensor lead wire is short-circuited.	Replace the conductivity sensor.
[ERR03] □ is flashing in Temperature Display.	Measured temperature has exceeded 110.0°C.	Check the measurement location environment.
[ERR04] □ is flashing in Temperature Display.	Measured temperature is less than 0.0°C.	Check the measurement location environment.
[ERR1] □ is indicating in Conductivity Display.	Internal memory is defective.	Contact our agency or us.

10.2 Key Operation

Problem	Possible Cause	Solution
<ul style="list-style-type: none"> • None of the set values can be changed. • The values do not change by the ,  keys. 	LOCK1  (Lock 1) is selected in [Set value lock (p.49)].	Select ----- (Unlock).
<ul style="list-style-type: none"> • Only EVT1, EVT2, EVT3, EVT4 values can be set. Other settings are not possible. • The values do not change by the ,  keys. 	LOCK2  (Lock 2) is selected in [Set value lock (p.49)].	Select ----- (Unlock).
Unable to enter Conductivity Calibration Mode.	LOCK1  (Lock 1), LOCK2  (Lock 2) or LOCK3  (Lock 3) has been selected in [Set value lock (p.49)].	Select ----- (Unlock).
Unable to enter Temperature Calibration Mode.	OFF  (No temperature compensation) is selected in [Temperature compensation method (p.23)].	Select any other item except OFF  (No temperature compensation).
	LOCK1  (Lock 1), LOCK2  (Lock 2) or LOCK3  (Lock 3) has been selected in [Set value lock (p.49)].	Select ----- (Unlock).

11. Character Tables

The following shows our character tables. Use the data column for reference. Depending on the model and settings, different items are available.

11.1 Setting Groups

Character	Setting Group
G_EC	Conductivity input group
G_TMP	Temperature input group
G_E01	EVT1 Group
G_E02	EVT2 Group
G_E03	EVT3 Group
G_E04	EVT4 Group
G_COM	Communication Group
G_TRA	Transmission Output Group
G_OTH	Special Function Group

11.2 Temperature Calibration Mode

Character	Setting Item, Setting Range	Factory Default	Data
SO (°C)	Temperature calibration value	0.0°C	
0.0	-10.0 to 10.0°C		

(*) SO and temperature are displayed alternately.

11.3 Conductivity Calibration Mode

Character	Setting Item, Setting Range	Factory Default	Data
ADJZ (*)	Conductivity Zero adjustment value	0.00	
0.00	Refer to (Tables 11.3-1, 11.3-2, 11.3-3).		
ADJS (*)	Temperature Span adjustment value	1.000	
1.000	0.700 to 1.300		

(*1) ADJZ and conductivity are displayed alternately.

(*2) ADJS and conductivity are displayed alternately.

FEB-102-ECH:

(Table 11.3-1)

Measurement Range		Conductivity Zero Adjustment Value Setting Range
Cell constant 1.0/cm	0.00 to 20.00 mS/cm	-2.00 to 2.00
	0.0 to 200.0 mS/cm	-20.0 to 20.0
	0.0 to 500.0 mS/cm	-50.0 to 50.0
	0 to 500 mS/cm	-50 to 50
	0.000 to 2.000 S/m	-0.200 to 0.200
	0.00 to 20.00 S/m	-2.00 to 2.00
	0.00 to 50.00 S/m	-5.00 to 5.00
	0.0 to 50.0 S/m	-5.0 to 5.0
	0 to 2000 mS/m	-200 to 200
	0.0 to 20.0 g/L	-2.0 to 2.0
	0 to 200 g/L	-20 to 20
	0 to 500 g/L	-50 to 50

(Table 11.3-2)

Measurement Range		Conductivity Zero Adjustment Value Setting Range
Cell constant 10.0/cm	0.0 to 200.0 mS/cm	-20.0 to 20.0
	0.0 to 500.0 mS/cm	-50.0 to 50.0
	0 to 2000 mS/cm	-200 to 200
	0.00 to 20.00 S/m	-2.00 to 2.00
	0.00 to 50.00 S/m	-5.00 to 5.00
	0.0 to 200.0 S/m	-20.0 to 20.0
	0 to 200 g/L	-20 to 20
	0 to 500 g/L	-50 to 50
	0 to 2000 g/L	-200 to 200
Seawater salinity	0.00 to 4.00%	-0.40 to 0.40
NaCl salinity	0.00 to 20.00%	-2.00 to 2.00

FEB-102-ECM:

(Table 11.3-3)

Cell Constant	Measurement Range	Conductivity Zero Adjustment Value Setting Range
0.01/cm	0.00 to 20.00 μ S/cm	-2.00 to 2.00
0.1/cm	0.0 to 200.0 μ S/cm	-20.0 to 20.0
1.0/cm	0 to 2000 μ S/cm	-200 to 200
0.01/cm	0.000 to 2.000 mS/m	-0.200 to 0.200
0.1/cm	0.00 to 20.00 mS/m	-2.00 to 2.00
1.0/cm	0.0 to 200.0 mS/m	-20.0 to 20.0
0.01/cm	0.0 to 20.0 mg/L	-2.0 to 2.0
0.1/cm	0 to 200 mg/L	-20 to 20
1.0/cm	0 to 2000 mg/L	-200 to 200

11.4 Transmission Output 1 Adjustment Mode

Character	Setting Item, Setting Range	Factory Default	Data
AJZ1 0.00	Transmission output 1 Zero adjustment value $\pm 5.00\%$ of Transmission output span	0.00%	
AJS1 0.00	Transmission output 1 Span adjustment value $\pm 5.00\%$ of Transmission output span	0.00%	

11.5 Transmission Output 2 Adjustment Mode

Character	Setting Item, Setting Range	Factory Default	Data
AJZ2 0.00	Transmission output 2 Zero adjustment value $\pm 5.00\%$ of Transmission output span	0.00%	
AJS2 0.00	Transmission output 2 Span adjustment value $\pm 5.00\%$ of Transmission output span	0.00%	

11.6 Simple Setting Mode

Character	Setting Item, Setting Range	Factory Default	Data
ESV1 0.00	EVT1 value	Conductivity input: Measurement range low limit Temperature input: 0.0°C	
	Conductivity input: Measurement range low limit to Measurement range high limit Temperature input: 0.0 to 100.0°C		
ESV2 0.00	EVT2 value	Conductivity input: Measurement range low limit Temperature input: 0.0°C	
	Conductivity input: Measurement range low limit to Measurement range high limit Temperature input: 0.0 to 100.0°C		
ESV3 0.00	EVT3 value	Conductivity input: Measurement range low limit Temperature input: 0.0°C	
	Conductivity input: Measurement range low limit to Measurement range high limit Temperature input: 0.0 to 100.0°C		
ESV4 0.00	EVT4 value	Conductivity input: Measurement range low limit Temperature input: 0.0°C	
	Conductivity input: Measurement range low limit to Measurement range high limit Temperature input: 0.0 to 100.0°C		

11.7 Conductivity Input Group

Character	Setting Item, Setting Range	Factory Default	Data
CELL 1.0	Sensor cell constant	FEB-102-ECH : 1.0/cm FEB-102-ECM : 0.01/cm	
	FEB-102-ECH: 1.0 : 1.0/cm 10.0 : 10.0/cm FEB-102-ECM: 0.01 : 0.01/cm 0.1 : 0.1/cm 1.0 : 1.0/cm		
COEF 1.000	Cell constant correction value 0.001 to 5.000	1.000	
UNIT CONV	Measurement unit	FEB-102-ECH : Conductivity (mS/cm) FEB-102-ECM : Conductivity (μS/cm)	
	FEB-102-ECH: CONV : Conductivity (mS/cm) SI : Conductivity (S/m, mS/m) SEA : Seawater salinity (%) SALT : NaCl salinity (%) TDS : TDS conversion (g/L) FEB-102-ECM: CONV : Conductivity (μS/cm) SI : Conductivity (mS/m) TDS : TDS conversion (mg/L)		

Character	Setting Item, Setting Range	Factory Default	Data																																				
MRNG 20.00	Measurement range	FEB-102-ECH : 0.00 to 20.00 mS/cm FEB-102-ECM : 0.00 to 20.00 μ S/cm (Fixed)																																					
	FEB-102-ECH: Selection items differ depending on the Sensor cell constant and Measurement unit. When Sensor cell constant 1.0/cm is selected:																																						
		<table border="1"> <thead> <tr> <th>Measurement Unit</th> <th>Selection Item</th> <th>Measurement Range</th> </tr> </thead> <tbody> <tr> <td rowspan="4">Conductivity (mS/cm)</td> <td>20.00</td> <td>0.00 to 20.00 mS/cm</td> </tr> <tr> <td>200.0</td> <td>0.0 to 200.0 mS/cm</td> </tr> <tr> <td>500.0</td> <td>0.0 to 500.0 mS/cm</td> </tr> <tr> <td>500</td> <td>0 to 500 mS/cm</td> </tr> <tr> <td rowspan="5">Conductivity (S/m)</td> <td>2.000</td> <td>0.000 to 2.000 S/m</td> </tr> <tr> <td>20.00</td> <td>0.00 to 20.00 S/m</td> </tr> <tr> <td>50.00</td> <td>0.00 to 50.00 S/m</td> </tr> <tr> <td>50.0</td> <td>0.0 to 50.0 S/m</td> </tr> <tr> <td>2000</td> <td>0 to 2000 mS/m</td> </tr> <tr> <td rowspan="3">TDS conversion (g/L)</td> <td>20.0</td> <td>0.0 to 20.0 g/L</td> </tr> <tr> <td>200</td> <td>0 to 200 g/L</td> </tr> <tr> <td>500</td> <td>0 to 500 g/L</td> </tr> <tr> <td>Seawater salinity (%)</td> <td>4.00</td> <td>0.00 to 4.00 %</td> </tr> <tr> <td>NaCl salinity (%)</td> <td>20.00</td> <td>0.00 to 20.00 %</td> </tr> </tbody> </table>	Measurement Unit	Selection Item	Measurement Range	Conductivity (mS/cm)	20.00	0.00 to 20.00 mS/cm	200.0	0.0 to 200.0 mS/cm	500.0	0.0 to 500.0 mS/cm	500	0 to 500 mS/cm	Conductivity (S/m)	2.000	0.000 to 2.000 S/m	20.00	0.00 to 20.00 S/m	50.00	0.00 to 50.00 S/m	50.0	0.0 to 50.0 S/m	2000	0 to 2000 mS/m	TDS conversion (g/L)	20.0	0.0 to 20.0 g/L	200	0 to 200 g/L	500	0 to 500 g/L	Seawater salinity (%)	4.00	0.00 to 4.00 %	NaCl salinity (%)	20.00	0.00 to 20.00 %	
	Measurement Unit	Selection Item	Measurement Range																																				
	Conductivity (mS/cm)	20.00	0.00 to 20.00 mS/cm																																				
		200.0	0.0 to 200.0 mS/cm																																				
		500.0	0.0 to 500.0 mS/cm																																				
		500	0 to 500 mS/cm																																				
	Conductivity (S/m)	2.000	0.000 to 2.000 S/m																																				
		20.00	0.00 to 20.00 S/m																																				
50.00		0.00 to 50.00 S/m																																					
50.0		0.0 to 50.0 S/m																																					
2000		0 to 2000 mS/m																																					
TDS conversion (g/L)	20.0	0.0 to 20.0 g/L																																					
	200	0 to 200 g/L																																					
	500	0 to 500 g/L																																					
Seawater salinity (%)	4.00	0.00 to 4.00 %																																					
NaCl salinity (%)	20.00	0.00 to 20.00 %																																					
When Sensor cell constant 10.0/cm is selected:																																							
	<table border="1"> <thead> <tr> <th>Measurement Unit</th> <th>Selection Item</th> <th>Measurement Range</th> </tr> </thead> <tbody> <tr> <td rowspan="3">Conductivity (mS/cm)</td> <td>200.0</td> <td>0.0 to 200.0 mS/cm</td> </tr> <tr> <td>500.0</td> <td>0.0 to 500.0 mS/cm</td> </tr> <tr> <td>2000</td> <td>0 to 2000 mS/cm</td> </tr> <tr> <td rowspan="3">Conductivity (S/m)</td> <td>20.00</td> <td>0.00 to 20.00 S/m</td> </tr> <tr> <td>50.00</td> <td>0.00 to 50.00 S/m</td> </tr> <tr> <td>200.0</td> <td>0.0 to 200.0 S/m</td> </tr> <tr> <td rowspan="3">TDS conversion (g/L)</td> <td>200</td> <td>0 to 200 g/L</td> </tr> <tr> <td>500</td> <td>0 to 500 g/L</td> </tr> <tr> <td>2000</td> <td>0 to 2000 g/L</td> </tr> <tr> <td>Seawater salinity (%)</td> <td>4.00</td> <td>0.00 to 4.00 %</td> </tr> <tr> <td>NaCl salinity (%)</td> <td>20.00</td> <td>0.00 to 20.00 %</td> </tr> </tbody> </table>	Measurement Unit	Selection Item	Measurement Range	Conductivity (mS/cm)	200.0	0.0 to 200.0 mS/cm	500.0	0.0 to 500.0 mS/cm	2000	0 to 2000 mS/cm	Conductivity (S/m)	20.00	0.00 to 20.00 S/m	50.00	0.00 to 50.00 S/m	200.0	0.0 to 200.0 S/m	TDS conversion (g/L)	200	0 to 200 g/L	500	0 to 500 g/L	2000	0 to 2000 g/L	Seawater salinity (%)	4.00	0.00 to 4.00 %	NaCl salinity (%)	20.00	0.00 to 20.00 %								
Measurement Unit	Selection Item	Measurement Range																																					
Conductivity (mS/cm)	200.0	0.0 to 200.0 mS/cm																																					
	500.0	0.0 to 500.0 mS/cm																																					
	2000	0 to 2000 mS/cm																																					
Conductivity (S/m)	20.00	0.00 to 20.00 S/m																																					
	50.00	0.00 to 50.00 S/m																																					
	200.0	0.0 to 200.0 S/m																																					
TDS conversion (g/L)	200	0 to 200 g/L																																					
	500	0 to 500 g/L																																					
	2000	0 to 2000 g/L																																					
Seawater salinity (%)	4.00	0.00 to 4.00 %																																					
NaCl salinity (%)	20.00	0.00 to 20.00 %																																					
FEB-102-ECM: Measurement range will be fixed by selecting the Sensor cell constant and Measurement unit.																																							
	<table border="1"> <thead> <tr> <th>Measurement Unit</th> <th>Sensor cell constant</th> <th>Item</th> <th>Measurement Range</th> </tr> </thead> <tbody> <tr> <td rowspan="3">Conductivity (μS/cm)</td> <td>0.01/cm</td> <td>20.00</td> <td>0.00 to 20.00 μS/cm</td> </tr> <tr> <td>0.1/cm</td> <td>200.0</td> <td>0.0 to 200.0 μS/cm</td> </tr> <tr> <td>1.0/cm</td> <td>2000</td> <td>0 to 2000 μS/cm</td> </tr> <tr> <td rowspan="3">Conductivity (mS/m)</td> <td>0.01/cm</td> <td>2.000</td> <td>0.000 to 2.000 mS/m</td> </tr> <tr> <td>0.1/cm</td> <td>20.00</td> <td>0.00 to 20.00 mS/m</td> </tr> <tr> <td>1.0/cm</td> <td>200.0</td> <td>0.0 to 200.0 mS/m</td> </tr> <tr> <td rowspan="3">TDS conversion (mg/L)</td> <td>0.01/cm</td> <td>20.0</td> <td>0.0 to 20.0 mg/L</td> </tr> <tr> <td>0.1/cm</td> <td>200</td> <td>0 to 200 mg/L</td> </tr> <tr> <td>1.0/cm</td> <td>2000</td> <td>0 to 2000 mg/L</td> </tr> </tbody> </table>	Measurement Unit	Sensor cell constant	Item	Measurement Range	Conductivity (μ S/cm)	0.01/cm	20.00	0.00 to 20.00 μ S/cm	0.1/cm	200.0	0.0 to 200.0 μ S/cm	1.0/cm	2000	0 to 2000 μ S/cm	Conductivity (mS/m)	0.01/cm	2.000	0.000 to 2.000 mS/m	0.1/cm	20.00	0.00 to 20.00 mS/m	1.0/cm	200.0	0.0 to 200.0 mS/m	TDS conversion (mg/L)	0.01/cm	20.0	0.0 to 20.0 mg/L	0.1/cm	200	0 to 200 mg/L	1.0/cm	2000	0 to 2000 mg/L				
Measurement Unit	Sensor cell constant	Item	Measurement Range																																				
Conductivity (μ S/cm)	0.01/cm	20.00	0.00 to 20.00 μ S/cm																																				
	0.1/cm	200.0	0.0 to 200.0 μ S/cm																																				
	1.0/cm	2000	0 to 2000 μ S/cm																																				
Conductivity (mS/m)	0.01/cm	2.000	0.000 to 2.000 mS/m																																				
	0.1/cm	20.00	0.00 to 20.00 mS/m																																				
	1.0/cm	200.0	0.0 to 200.0 mS/m																																				
TDS conversion (mg/L)	0.01/cm	20.0	0.0 to 20.0 mg/L																																				
	0.1/cm	200	0 to 200 mg/L																																				
	1.0/cm	2000	0 to 2000 mg/L																																				

Character	Setting Item, Setting Range	Factory Default	Data
TDSK <input type="checkbox"/> <input type="checkbox"/> <input type="checkbox"/> <input type="checkbox"/> 0.50	TDS conversion factor 0.30 to 1.00	0.50	
FIT1 <input type="checkbox"/> <input type="checkbox"/> <input type="checkbox"/> <input type="checkbox"/> 0.0	Conductivity input filter time constant 0.0 to 10.0 seconds	0.0 sec.	
ESO <input type="checkbox"/> <input type="checkbox"/> <input type="checkbox"/> <input type="checkbox"/> 0.00	Conductivity input sensor correction ±10% or Measurement span	0.00	

11.8 Temperature Input Group

Character	Setting Item, Setting Range	Factory Default	Data
SENS <input type="checkbox"/> PT100 <input type="checkbox"/>	RTD type PT100 <input type="checkbox"/> : Pt100 PT1000 <input type="checkbox"/> : Pt1000	Pt100	
TCM <input type="checkbox"/> NACL <input type="checkbox"/>	Temperature compensation method FEB-102-ECH: NACL <input type="checkbox"/> : Temperature compensation is conducted using temperature characteristics of NaCl. Select when the main ingredient of salt included in a sample is NaCl. TCOE <input type="checkbox"/> : Temperature compensation is conducted using temperature coefficient (%/°C) and randomly selected reference temperature. OFF <input type="checkbox"/> : No temperature compensation FEB-102-ECM: NACL <input type="checkbox"/> : Temperature compensation is conducted using temperature characteristics of NaCl. Select when the main ingredient of salt included in a sample is NaCl. TCOE <input type="checkbox"/> : Temperature compensation is conducted using temperature coefficient (%/°C) and randomly selected reference temperature. PURE <input type="checkbox"/> : Temperature compensation is conducted using temperature characteristics of pure (deionized) water. OFF <input type="checkbox"/> : No temperature compensation	FEB-102-ECH: NaCl FEB-102-ECM: NaCl	
KCOE <input type="checkbox"/> <input type="checkbox"/> <input type="checkbox"/> <input type="checkbox"/> 2.00	Temperature coefficient -5.00 to 5.00 %/°C	2.00 %/°C	
STND <input type="checkbox"/> <input type="checkbox"/> <input type="checkbox"/> <input type="checkbox"/> 25.0	Reference temperature 5.0 to 95.0°C	25.0°C	
DP2 <input type="checkbox"/> <input type="checkbox"/> <input type="checkbox"/> <input type="checkbox"/> 0.0	Decimal point place <input type="checkbox"/> <input type="checkbox"/> <input type="checkbox"/> <input type="checkbox"/> 0 : No decimal point <input type="checkbox"/> <input type="checkbox"/> <input type="checkbox"/> <input type="checkbox"/> 0.0 : 1 digit after decimal point	1 digit after decimal point	
CNECT <input type="checkbox"/> 3WIRE <input type="checkbox"/>	Pt100 input wire type 2WIRE <input type="checkbox"/> : 2-wire type 3WIRE <input type="checkbox"/> : 3-wire type	3-wire type	
CABLE <input type="checkbox"/> <input type="checkbox"/> <input type="checkbox"/> <input type="checkbox"/> 0.0	Cable length correction 0.0 to 100.0 m	0.0 m	
CSEC <input type="checkbox"/> <input type="checkbox"/> <input type="checkbox"/> <input type="checkbox"/> 0.30	Cable cross-section area 0.10 to 2.00 mm ²	0.30 mm ²	
FIT2 <input type="checkbox"/> <input type="checkbox"/> <input type="checkbox"/> <input type="checkbox"/> 0.0	Temperature input filter time constant 0.0 to 10.0 seconds	0.0 sec.	

11.9 EVT1 Group

Character	Setting Item, Setting Range	Factory Default	Data
EVT1F -----	EVT1 type ----- : No action EC-L : Conductivity input low limit action EC-H : Conductivity input high limit action TEMP-L : Temperature input low limit action TEMP-H : Temperature input high limit action EROUT : Error output FAIL : Fail output EEUL : Conductivity input error alarm output	No action	
ESV1 0.00	EVT1 value Conductivity input: Measurement range low limit to Measurement range high limit Temperature input: 0.0 to 100.0°C	Conductivity input: Measurement range low limit Temperature input: 0.0°C	
EP1 0.00	EVT1 proportional band Conductivity input: 0 to Measurement span Temperature input: 0.0 to 100.0°C	Conductivity input: Measurement range low limit Temperature input: 0.0°C	
E1RST 0.00	EVT1 reset Conductivity input: ±10% of Measurement span Temperature input: ±100.0°C	Conductivity input: 0 Temperature input: 0.0°C	
E1DIF SDIF	EVT1 hysteresis type CDIF : Medium value SDIF : Reference value	Reference value	
E1DFO 0.10	EVT1 ON side Conductivity input: 0 to 20% of Measurement range high limit Temperature input: 0.0 to 10.0°C	Conductivity input: 0.01 Temperature input: 1.0°C	
E1DFU 0.10	EVT1 OFF side Conductivity input: 0 to 20% of Measurement range high limit Temperature input: 0.0 to 10.0°C	Conductivity input: 0.01 Temperature input: 1.0°C	
E10NT 0	EVT1 ON delay time 0 to 10000 seconds	0 sec.	
E10FT 0	EVT1 OFF delay time 0 to 10000 seconds	0 sec.	
E1C 30	EVT1 proportional cycle 1 to 300 seconds	30 sec.	
E10LH 100	EVT1 output high limit EVT1 output low limit to 100%	100%	
E10LL 0	EVT1 output low limit 0% to EVT1 output high limit	0%	
00NT1 0	Output ON time when EVT1 output ON 0 to 10000 seconds	0 sec.	
00FT1 0	Output OFF time when EVT1 output ON 0 to 10000 seconds	0 sec.	

Character	Setting Item, Setting Range	Factory Default	Data
E1CS -----	EVT1 conductivity input error alarm EVT□ type ----- : No action EVT2□ : EVT2 type EVT3□ : EVT3 type EVT4□ : EVT4 type	No action	
E1EO □□□0.00	EVT1 conductivity input error alarm span when EVT□ output ON Measurement range low limit to Measurement range high limit	Measurement range low limit	
E1EOT □□□□0	EVT1 conductivity input error alarm time when EVT□ output ON 0 to 10000 seconds or minutes	0 sec.	
E1EC □□□0.00	EVT1 conductivity input error alarm span when EVT□ output OFF Measurement range low limit to Measurement range high limit	Measurement range low limit	
E1ECT □□□□0	EVT1 conductivity input error alarm time when EVT□ output OFF 0 to 10000 seconds or minutes	0 sec.	
MVZN1 □□50.0	EVT1 cycle variable range 1.0 to 100.0%	50.0%	
CENT1 □□□□0	EVT1 cycle extended time 0 to 300 seconds	0 sec.	

11.10 EVT2 Group

Character	Setting Item, Setting Range	Factory Default	Data
EVT2F -----	EVT2 type ----- : No action EC-L□ : Conductivity input low limit action EC-H□ : Conductivity input high limit action TEMPL□ : Temperature input low limit action TEMPH□ : Temperature input high limit action EROUT□ : Error output FAIL□ : Fail output EEUL□ : Conductivity input error alarm output	No action	
ESV2 □□□0.00	EVT2 value Conductivity input: Measurement range low limit to Measurement range high limit Temperature input: 0.0 to 100.0°C	Conductivity input: Measurement range low limit Temperature input: 0.0°C	
EP2 □□□0.00	EVT2 proportional band Conductivity input: 0 to Measurement span Temperature input: 0.0 to 100.0°C	Conductivity input: Measurement range low limit Temperature input: 0.0°C	
E2RST □□□0.00	EVT2 reset Conductivity input: ±10% of Measurement span Temperature input: ±100.0°C	Conductivity input: 0 Temperature input: 0.0°C	
E2DIF SDIF□□	EVT2 hysteresis type CDIF□ : Medium value SDIF□ : Reference value	Reference value	

Character	Setting Item, Setting Range	Factory Default	Data
E2DF0 0.10	EVT2 ON side Conductivity input: 0 to 20% of Measurement range high limit Temperature input: 0.0 to 10.0°C	Conductivity input: 0.01 Temperature input: 1.0°C	
E2DFU 0.10	EVT2 OFF side Conductivity input: 0 to 20% of Measurement range high limit Temperature input: 0.0 to 10.0°C	Conductivity input: 0.01 Temperature input: 1.0°C	
E20NT 0	EVT2 ON delay time 0 to 10000 seconds	0 sec.	
E20FT 0	EVT2 OFF delay time 0 to 10000 seconds	0 sec.	
E2C 30	EVT2 proportional cycle 1 to 300 seconds	30 sec.	
E20LH 100	EVT2 output high limit EVT2 output low limit to 100%	100%	
E20LL 0	EVT2 output low limit 0% to EVT2 output high limit	0%	
00NT2 0	Output ON time when EVT2 output ON 0 to 10000 seconds	0 sec.	
00FT2 0	Output OFF time when EVT2 output ON 0 to 10000 seconds	0 sec.	
E2CS -----	EVT2 conductivity input error alarm EVT type EVT1 : EVT1 type ----- : No action EVT3 : EVT3 type EVT4 : EVT4 type	No action	
E2E0 0.00	EVT2 conductivity input error alarm span when EVT output ON Measurement range low limit to Measurement range high limit	Measurement range low limit	
E2E0T 0	EVT2 conductivity input error alarm time when EVT output ON 0 to 10000 seconds or minutes	0 sec.	
E2EC 0.00	EVT2 conductivity input error alarm span when EVT output OFF Measurement range low limit to Measurement range high limit	Measurement range low limit	
E2ECT 0	EVT2 conductivity input error alarm time when EVT output OFF 0 to 10000 seconds or minutes	0 sec.	
MVZN2 50.0	EVT2 cycle variable range 1.0 to 100.0%	50.0%	
CENT2 0	EVT2 cycle extended time 0 to 300 seconds	0 sec.	

11.11 EVT3 Group

Character	Setting Item, Setting Range	Factory Default	Data
EVT3F -----	EVT3 type ----- : No action EC-L : Conductivity input low limit action EC-H : Conductivity input high limit action TEMPL : Temperature input low limit action TEMPH : Temperature input high limit action EROUT : Error output FAIL : Fail output EEUL : Conductivity input error alarm output	No action	
ESV3 0.00	EVT3 value Conductivity input: Measurement range low limit to Measurement range high limit Temperature input: 0.0 to 100.0°C	Conductivity input: Measurement range low limit Temperature input: 0.0°C	
EP3 0.00	EVT3 proportional band Conductivity input: 0 to Measurement span Temperature input: 0.0 to 100.0°C	Conductivity input: Measurement range low limit Temperature input: 0.0°C	
E3RST 0.00	EVT3 reset Conductivity input: ±10% of Measurement span Temperature input: ±100.0°C	Conductivity input: 0 Temperature input: 0.0°C	
E3DIF SDIF	EVT3 hysteresis type CDIF : Medium value SDIF : Reference value	Reference value	
E3DFO 0.10	EVT3 ON side Conductivity input: 0 to 20% of Measurement range high limit Temperature input: 0.0 to 10.0°C	Conductivity input: 0.01 Temperature input: 1.0°C	
E3DFU 0.10	EVT3 OFF side Conductivity input: 0 to 20% of Measurement range high limit Temperature input: 0.0 to 10.0°C	Conductivity input: 0.01 Temperature input: 1.0°C	
E30NT 0	EVT3 ON delay time 0 to 10000 seconds	0 sec.	
E30FT 0	EVT3 OFF delay time 0 to 10000 seconds	0 sec.	
E3C 30	EVT3 proportional cycle 1 to 300 seconds	30 sec.	
E30LH 100	EVT3 output high limit EVT3 output low limit to 100%	100%	
E30LL 0	EVT3 output low limit 0% to EVT3 output high limit	0%	
00NT3 0	Output ON time when EVT3 output ON 0 to 10000 seconds	0 sec.	
00FT3 0	Output OFF time when EVT3 output ON 0 to 10000 seconds	0 sec.	

Character	Setting Item, Setting Range	Factory Default	Data
E3CS -----	EVT3 conductivity input error alarm EVT□ type EVT1□ : EVT1 type EVT2□ : EVT2 type ----- : No action EVT4□ : EVT4 type	No action	
E3E0 □□□0.00	EVT3 conductivity input error alarm span when EVT□ output ON Measurement range low limit to Measurement range high limit	Measurement range low limit	
E3E0T □□□□0	EVT3 conductivity input error alarm time when EVT□ output ON 0 to 10000 seconds or minutes	0 sec.	
E3EC □□□0.00	EVT3 conductivity input error alarm span when EVT□ output OFF Measurement range low limit to Measurement range high limit	Measurement range low limit	
E3ECT □□□□0	EVT3 conductivity input error alarm time when EVT□ output OFF 0 to 10000 seconds or minutes	0 sec.	
MVZN3 □□□50.0	EVT3 cycle variable range 1.0 to 100.0%	50.0%	
CENT3 □□□□0	EVT3 cycle extended time 0 to 300 seconds	0 sec.	

11.12 EVT4 Group

Character	Setting Item, Setting Range	Factory Default	Data
EVT4F -----	EVT4 type ----- : No action EC-L□ : Conductivity input low limit action EC-H□ : Conductivity input high limit action TEMPL□ : Temperature input low limit action TEMPH□ : Temperature input high limit action EROUT□ : Error output FAIL□ : Fail output EEUL□ : Conductivity input error alarm output	No action	
ESV4 □□□0.00	EVT4 value Conductivity input: Measurement range low limit to Measurement range high limit Temperature input: 0.0 to 100.0°C	Conductivity input: Measurement range low limit Temperature input: 0.0°C	
EP4 □□□0.00	EVT4 proportional band Conductivity input: 0 to Measurement span Temperature input: 0.0 to 100.0°C	Conductivity input: Measurement range low limit Temperature input: 0.0°C	
E4RST □□□0.00	EVT4 reset Conductivity input: ±10% of Measurement span Temperature input: ±100.0°C	Conductivity input: 0 Temperature input: 0.0°C	
E4DIF SDIF□□	EVT4 hysteresis type CDIF□ : Medium value SDIF□ : Reference value	Reference value	

Character	Setting Item, Setting Range	Factory Default	Data
E4DF0 0.10	EVT4 ON side Conductivity input: 0 to 20% of Measurement range high limit Temperature input: 0.0 to 10.0°C	Conductivity input: 0.01 Temperature input: 1.0°C	
E4DFU 0.10	EVT4 OFF side Conductivity input: 0 to 20% of Measurement range high limit Temperature input: 0.0 to 10.0°C	Conductivity input: 0.01 Temperature input: 1.0°C	
E40NT 0	EVT4 ON delay time 0 to 10000 seconds	0 sec.	
E40FT 0	EVT4 OFF delay time 0 to 10000 seconds	0 sec.	
E4C 30	EVT4 proportional cycle 1 to 300 seconds	30 sec.	
E40LH 100	EVT4 output high limit EVT4 output low limit to 100%	100%	
E40LL 0	EVT4 output low limit 0% to EVT4 output high limit	0%	
00NT4 0	Output ON time when EVT4 output ON 0 to 10000 seconds	0 sec.	
00FT4 0	Output OFF time when EVT4 output ON 0 to 10000 seconds	0 sec.	
E4CS -----	EVT4 conductivity input error alarm EVT□ type EVT1□ : EVT1 type EVT2□ : EVT2 type EVT3□ : EVT3 type ----- : No action	No action	
E4E0 0.00	EVT4 conductivity input error alarm span when EVT□ output ON Measurement range low limit to Measurement range high limit	Measurement range low limit	
E4EOT 0	EVT4 conductivity input error alarm time when EVT□ output ON 0 to 10000 seconds or minutes	0 sec.	
E4EC 0.00	EVT4 conductivity input error alarm span when EVT□ output OFF Measurement range low limit to Measurement range high limit	Measurement range low limit	
E4ECT 0	EVT4 conductivity input error alarm time when EVT□ output OFF 0 to 10000 seconds or minutes	0 sec.	
MVZN4 50.0	EVT4 cycle variable range 1.0 to 100.0%	50.0%	
CENT4 0	EVT4 cycle extended time 0 to 300 seconds	0 sec.	

11.13 Communication Group

Character	Setting Item, Setting Range	Factory Default	Data
CMSL□ NOML□□	Communication protocol NOML□□ : Shinko protocol MODA□□ : Modbus ASCII mode MODR□□ : Modbus RTU mode	Shinko protocol	
CMNO□ □□□□0	Instrument number 0 to 95	0	
CMSP□ □□9600	Communication speed □□9600 : 9600 bps □□19200 : 19200 bps □□38400 : 38400 bps	9600 bps	
CMFT□ 7EVN□□	Data bit/Parity 8NON□□ : 8 bits/No parity 7NON□□ : 7 bits/No parity 8EVN□□ : 8 bits/Even 7EVN□□ : 7 bits/Even 8ODD□□ : 8 bits/Odd 7ODD□□ : 7 bits/Odd	7 bits/Even	
CMST□ □□□□1	Stop bit □□□□1 : 1 bit □□□□2 : 2 bits	1 bit	

11.14 Transmission Output Group

Character	Setting Item, Setting Range	Factory Default	Data
TROS1 EC□□□□	Transmission output 1 type EC□□□□ : Conductivity transmission TEMP□□ : Temperature transmission MV1□□□ : EVT1 MV transmission MV2□□□ : EVT2 MV transmission	Conductivity transmission	
TRLH1 □□20.00	Transmission output 1 high limit Conductivity transmission: Transmission output 1 low limit to Measurement range high limit Temperature transmission: Transmission output 1 low limit to 100.0°C MV transmission: Transmission output 1 low limit to 100.0%	Conductivity transmission: 20.00 Temperature transmission: 100.0°C MV transmission: 100.0%	
TRLL1 □□0.00	Transmission output 1 low limit Conductivity transmission: Measurement range low limit to Transmission output 1 high limit Temperature transmission: 0.0°C to Transmission output 1 high limit MV transmission: 0.0% to Transmission output 1 high limit	Conductivity transmission: 0.00 Temperature transmission: 0.0°C MV transmission: 0.0%	
TRCS1 BEFH□□	Transmission output 1 status when calibrating BEFH□□ : Last value HOLD SETH□□ : Set value HOLD PVH□□□ : Measurement value	Last value HOLD	
TRSE1 □□0.00	Transmission output 1 Set value HOLD Conductivity transmission: Measurement range low limit to Measurement range high limit Temperature transmission: 0.0 to 100.0°C MV transmission: 0.0 to 100.0%	Conductivity transmission: Measurement range low limit Temperature transmission: 0.0°C MV transmission: 0.0%	

Character	Setting Item, Setting Range	Factory Default	Data
TR0S2 EC [] [] [] []	Transmission output 2 type EC [] [] [] [] : Conductivity transmission TEMP [] [] [] [] : Temperature transmission MV1 [] [] [] [] : EVT1 MV transmission MV2 [] [] [] [] : EVT2 MV transmission MV3 [] [] [] [] : EVT3 MV transmission	Conductivity transmission	
TRLH2 [] [] 20.00	Transmission output 2 high limit Conductivity transmission: Transmission output 2 low limit to Measurement range high limit Temperature transmission: Transmission output 2 low limit to 100.0°C MV transmission: Transmission output 2 low limit to 100.0%	Conductivity transmission: 20.00 Temperature transmission: 100.0°C MV transmission: 100.0%	
TRLL2 [] [] [] 0.00	Transmission output 2 low limit Conductivity transmission: Measurement range low limit to Transmission output 2 high limit Temperature transmission: 0.0°C to Transmission output 2 high limit MV transmission: 0.0% to Transmission output 2 high limit	Conductivity transmission: 0.00 Temperature transmission: 0.0°C MV transmission: 0.0%	
TRCS2 BEFH [] [] []	Transmission output 2 status when calibrating BEFH [] [] [] [] : Last value HOLD SETH [] [] [] [] : Set value HOLD PVH [] [] [] [] : Measurement value	Last value HOLD	
TRSE2 [] [] [] 0.00	Transmission output 2 Set value HOLD Conductivity transmission: Measurement range low limit to Measurement range high limit Temperature transmission: 0.0 to 100.0°C MV transmission: 0.0 to 100.0%	Conductivity transmission: Measurement range low limit Temperature transmission: 0.0°C MV transmission: 0.0%	

11.15 Special Function Group

Character	Setting Item, Setting Range	Factory Default	Data
LOCK [] -----	Set value lock ----- : Unlock LOCK1 [] [] [] [] : Lock 1 LOCK2 [] [] [] [] : Lock 2 LOCK3 [] [] [] [] : Lock 3	Unlock	
DISP [] DUAL [] [] [] []	Display selection DUAL [] [] [] [] : Input value (Conductivity, Temperature) EC [] [] [] [] : Conductivity TEMP [] [] [] [] : Temperature	Input value (Conductivity, Temperature)	
INERR OFF [] [] [] []	EVT output when input errors occur ON [] [] [] [] : Enabled OFF [] [] [] [] : Disabled	Disabled	
OFDP [] OFF [] [] [] []	Temperature Display when no temperature compensation OFF [] [] [] [] : Unlit STD [] [] [] [] : Reference temperature PV [] [] [] [] : Measurement value	Unlit	
M_S [] SEC [] [] [] []	Conductivity input error alarm time unit SEC [] [] [] [] : Second(s) MIN [] [] [] [] : Minute(s)	Second(s)	

12. Key Operation Flowchart

Abbreviations: Con.: Conductivity
Temp.: Temperature
Trans.: Transmission

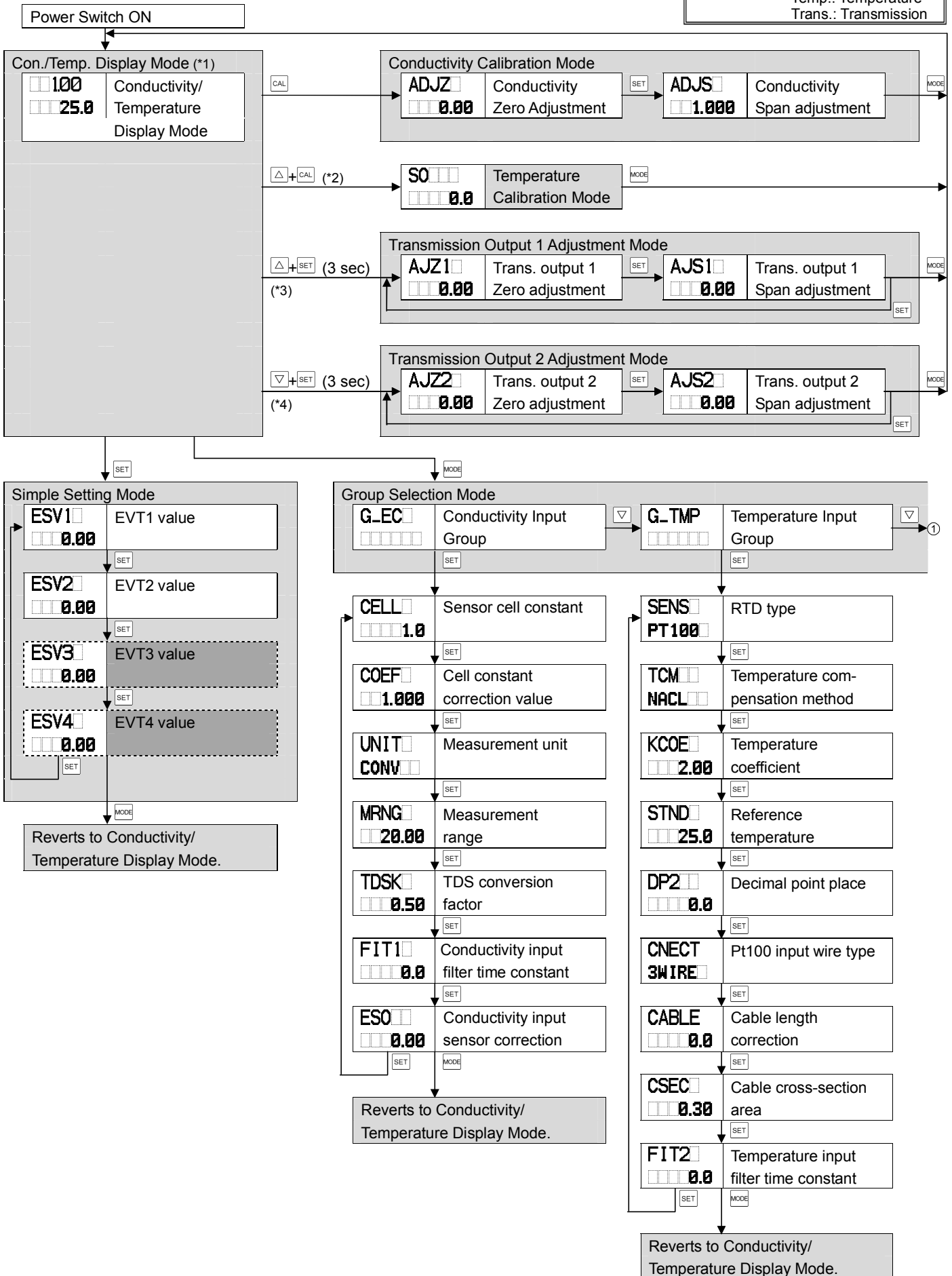

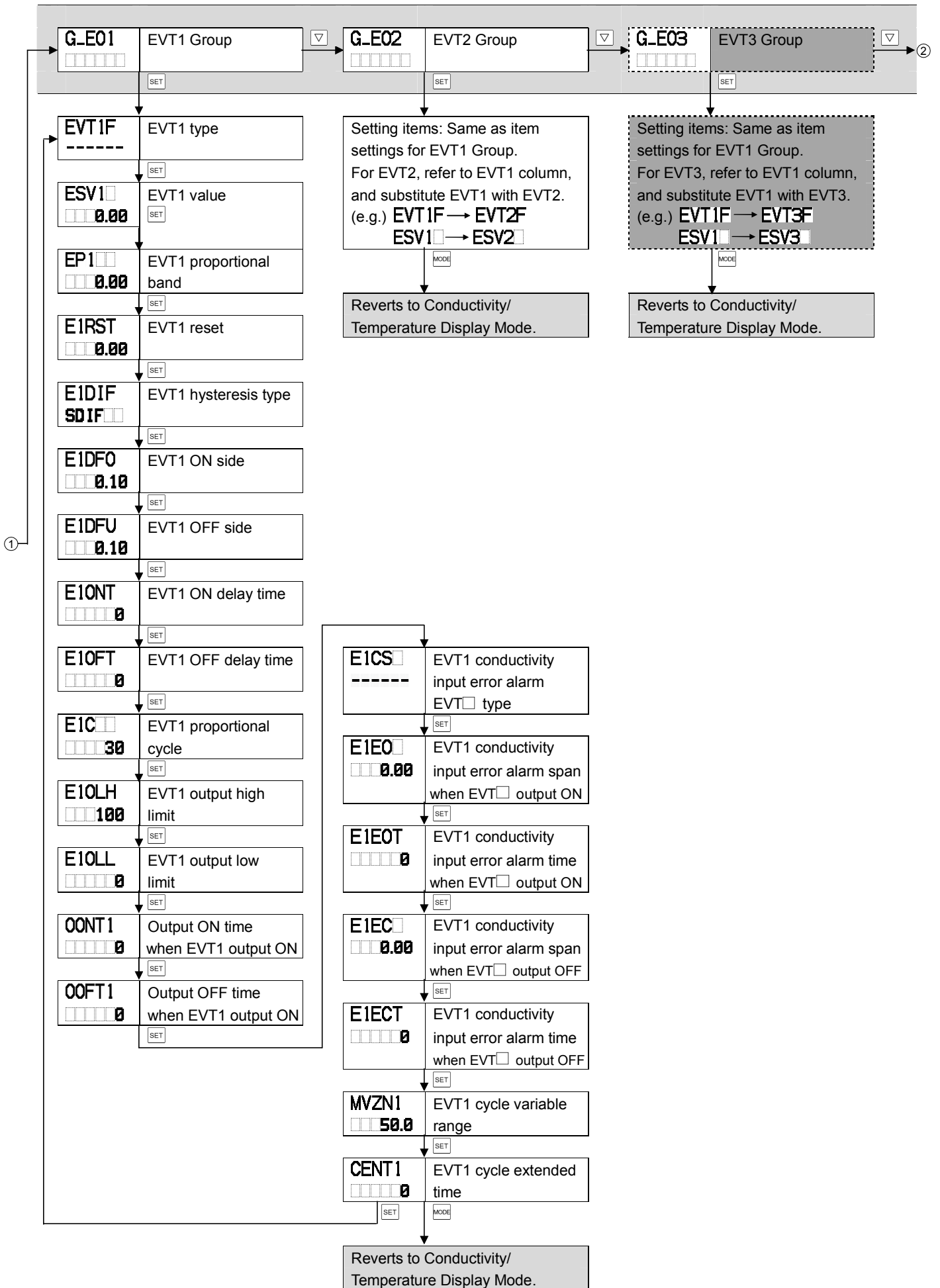

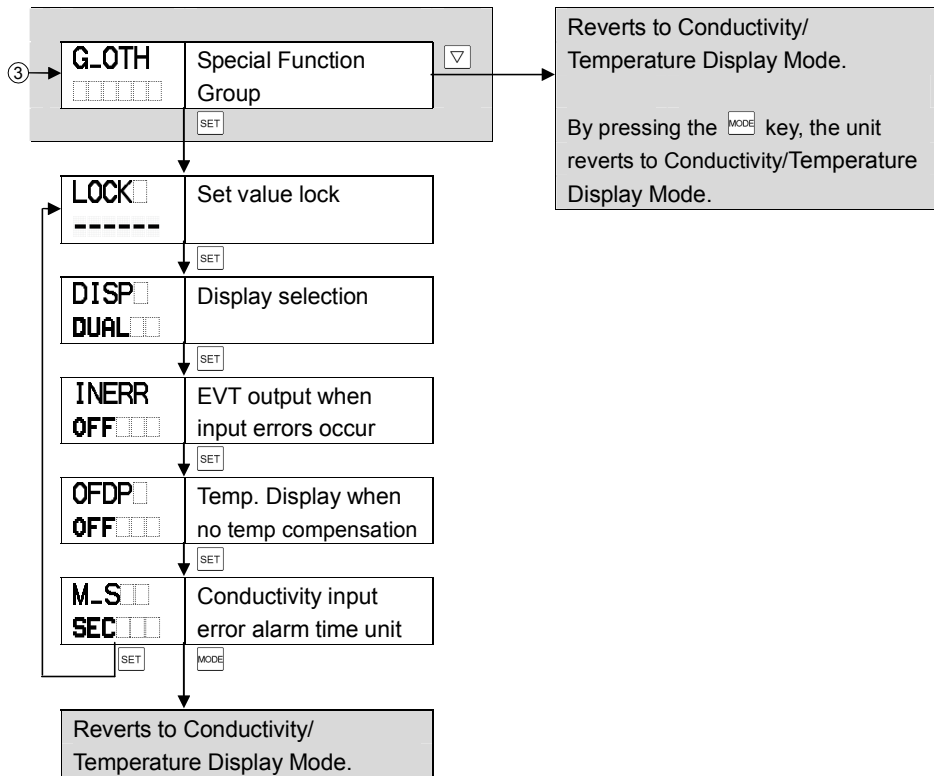

[Each Mode and Setting Item]

ESV1	EVT1 value
0.00	

- Upper left: Conductivity Display: Indicates the setting item characters.
- Lower left: Temperature Display: Indicates the factory default.
- Right side: Indicates the setting item.

(*1) Indicates the item selected in [Display selection (p.49)] or in [Temperature Display when no temperature compensation (p.49)] in Conductivity/Temperature Display Mode.

(*2) If **OFF** (No temperature compensation) is selected in [Temperature compensation method (p.23)], the unit will not enter Temperature Calibration Mode.

(*3) If C5, EVT3 or EVT4 option is ordered, the unit will not enter Transmission Output 1 Adjustment Mode.

(*4) If C5 or EVT4 is ordered, the unit will not enter Transmission Output 2 Adjustment Mode.

----- : Available only when the corresponding option is ordered.

[Key Operation]

- **SET**, **CAL**, **MODE**, **▽** : If the **SET**, **CAL**, **MODE** or **▽** key is pressed, the unit will proceed to the next setting item, illustrated by an arrow.
- **△**+**CAL** : Press and hold **△** and **CAL** (in that order) together. The unit will enter Temperature Calibration Mode.
- **△**+**SET** (3 sec) : Press and hold the **△** and **SET** keys (in that order) together for 3 seconds.
The unit will proceed to Transmission Output 1 Adjustment Mode.
- **▽**+**SET** (3 sec) : Press and hold the **▽** and **SET** keys (in that order) together for 3 seconds.
The unit will proceed to Transmission Output 2 Adjustment Mode.
- If the **MODE** key is pressed at each setting item, the unit will revert to Conductivity/Temperature Display Mode.

***** Inquiries *****

For any inquiries about this unit, please contact our agency or the vendor where you purchased the unit after checking the following.

[Example]

- Model ----- FEB-102-ECH
- Serial number ----- No. 142F05000

In addition to the above, please let us know the details of the malfunction, or discrepancy, and the operating conditions.

SHINKO TECHNOS CO., LTD.
OVERSEAS DIVISION

Head Office : 2-5-1, Senbahigashi, Minoo, Osaka, Japan

URL: <http://www.shinko-technos.co.jp>

E-mail: overseas@shinko-technos.co.jp

Tel : +81-72-727-6100

Fax: +81-72-727-7006