

**ON-SITE Type pH/ORP Meter**

**FEB-102-PH**

**Instruction Manual**

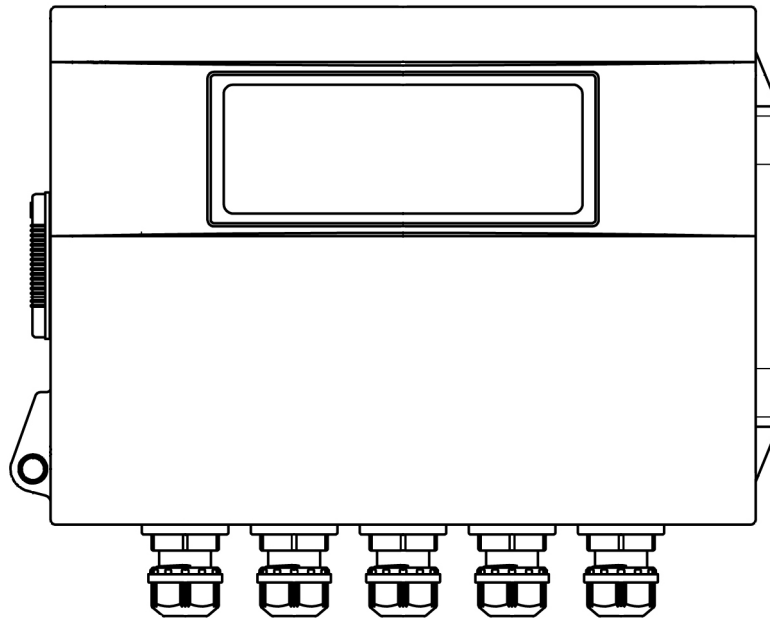

***Shinko***

# Preface

Thank you for purchasing our FEB-102-PH, ON-SITE Type pH/ORP Meter.

This manual contains instructions for the mounting, functions, operations and notes when operating the FEB-102-PH. To ensure safe and correct use, thoroughly read and understand this manual before using this instrument. To prevent accidents arising from the misuse of this instrument, please ensure the operator receives this manual.

## Caution

- This instrument should be used in accordance with the specifications described in the manual. If it is not used according to the specifications, it may malfunction or cause a fire.
- Be sure to follow all of the warnings, cautions and notices. If they are not observed, serious injury or malfunction may occur.
- The contents of this instruction manual are subject to change without notice.
- Care has been taken to ensure that the contents of this instruction manual are correct, but if there are any doubts, mistakes or questions, please inform our sales department.
- This instrument is designed to be wall-mounted. Measures must be taken to ensure that the operator cannot touch power terminals or other high voltage sections.
- Any unauthorized transfer or copying of this document, in part or in whole, is prohibited.
- Shinko Technos Co., Ltd. is not liable for any damage or secondary damage(s) incurred as a result of using this product, including any indirect damage.

## Safety Precautions (Be sure to read these precautions before using our products.)

The safety precautions are classified into 2 categories: "Warning" and "Caution".

Depending on the circumstances, procedures indicated by  Caution may result in serious consequences, so be sure to follow the directions for usage.



### Warning

Procedures which may lead to dangerous conditions and cause death or serious injury, if not carried out properly.



### Caution

Procedures which may lead to dangerous conditions and cause superficial to medium injury or physical damage or may degrade or damage the product, if not carried out properly.



### Warning

- To prevent an electrical shock or fire, only Shinko or other qualified service personnel may handle the inner assembly.
- To prevent an electrical shock, fire or damage to the instrument, parts replacement may only be undertaken by Shinko or other qualified service personnel.



### SAFETY PRECAUTIONS

- To ensure safe and correct use, thoroughly read and understand this manual before using this instrument.
- This instrument is intended to be used for industrial machinery, machine tools and measuring equipment. Verify correct usage after purpose-of-use consultation with our agency or main office. (Never use this instrument for medical purposes with which human lives are involved.)
- External protection devices such as protective equipment against excessive temperature rise, etc. must be installed, as malfunction of this product could result in serious damage to the system or injury to personnel. Proper periodic maintenance is also required.
- This instrument must be used under the conditions and environment described in this manual. Shinko Technos Co., Ltd. does not accept liability for any injury, loss of life or damage occurring due to the instrument being used under conditions not otherwise stated in this manual.



### Caution with respect to Export Trade Control Ordinance

To avoid this instrument from being used as a component in, or as being utilized in the manufacture of weapons of mass destruction (i.e. military applications, military equipment, etc.), please investigate the end users and the final use of this instrument. In the case of resale, ensure that this instrument is not illegally exported.

# PRECAUTIONS

## 1. Installation Precautions

### **Caution**

This instrument is intended to be used under the following environmental conditions (IEC61010-1):

- Overvoltage category II, Pollution degree 2

Ensure the mounting location corresponds to the following conditions:

- A minimum of dust, and an absence of corrosive gases
- No flammable, explosive gases
- No mechanical vibrations or shocks
- No exposure to direct sunlight, an ambient temperature of -20 to 50°C (-4 to 122°F) that does not change rapidly, and no icing
- An ambient non-condensing humidity of 35 to 95 %RH
- No large capacity electromagnetic switches or cables through which large current is flowing.
- No water, oil or chemicals or where the vapors of these substances can come into direct contact with the unit
- The ambient temperature of the unit must be kept to under 50°C. Otherwise the life of electronic parts (especially electrolytic capacitors) of the unit will be shortened.

**Note: Do not install this instrument on or near flammable material even though the case of this instrument is made of flame-resistant resin.**

## 2. Wiring Precautions

### **Caution**

- Use a ring-type solderless terminal with an insulation sleeve in which the M3 screw fits when wiring the FEB-102-PH.
- Tighten the terminal screw using the specified torque. If excessive force is applied to the screw when tightening, the terminal screw may be damaged.
- This instrument does not have a built-in power switch, circuit breaker and fuse.  
It is necessary to install a power switch, circuit breaker and fuse near the instrument.  
(Recommended fuse: Time-lag fuse, rated voltage 250 V AC, rated current 2 A)
- Do not apply a commercial power source to the sensor which is connected to the input terminal nor allow the power source to come into contact with the sensor.
- Use the pH/ORP Combined Electrode Sensor in accordance with the sensor input specifications of the FEB-102-PH.
- Keep the sensor cables and power cables separate, do not put them in the same cable clamp.

#### **Note about the pH/ORP Combined Electrode Sensor Cable**

The pH/ORP Combined Electrode Sensor cable is a highly-insulated (electrical) cable. Please handle it with utmost care as follows.

- Do not allow terminals and socket of the pH/ORP Combined Electrode Sensor cable to come in contact with moisture or oil of any kind. Likewise, ensure fingers are clean, otherwise the insulation will deteriorate, resulting in unstable indication.  
Be sure to keep the cable dry and clean at all times.  
If the cable is stained, clean it with alcohol, and dry it completely.
- For calibration or electrode checking/replacement, the pH/ORP Combined Electrode Sensor cable should be wired with sufficient length.
- Keep the pH/ORP Combined Electrode Sensor cable and junction cable away from electrical devices, such as motors or their power lines from which inductive interference emanates.

### Connection

The pH Combined Electrode Sensor cable has the following terminals.

Symbol	Terminal
G	Glass electrode terminal
R	Reference electrode terminal
T, T	Temperature compensation electrode terminals (Cu500)
A, B, B	Temperature compensation electrode terminals (Pt100 or Pt1000)
E	Shield wire terminal

For the pH/ORP Combined Electrode Sensor with no temperature compensation, T, T or A, B, B cables are not available.

E cables are available depending on the sensor type.

ORP Combined Electrode Sensor cable has the following terminals.

Symbol	Terminal
M	Metal electrode terminal
R	Reference electrode terminal

### 3. Operation and Maintenance Precautions



#### Caution

- Do not touch live terminals. This may cause an electrical shock or problems in operation.
- Turn the power switch to the instrument OFF when retightening the terminal or cleaning.  
Working on or touching the terminal with the power switched ON may result in severe injury or death due to electrical shock.
- Use a soft, dry cloth when cleaning the instrument.  
(Alcohol based substances may tarnish or deface the unit.)
- As the display section is vulnerable, be careful not to put pressure on, scratch or strike it with a hard object.

# Contents

	Page
<b>1. Model</b>	
1.1 Model -----	7
1.2 How to Read the Model Label -----	7
<b>2. Names and Functions of Sections</b>	
2.1 Main Body of FEB-102-PH -----	8
2.2 How to Open the Cover	
2.2.1 Open the Cover -----	8
2.2.2 Close the Cover -----	9
2.3 Display and Operation Panel -----	10
<b>3. Mounting</b>	
3.1 Site Selection -----	11
3.2 External Dimensions (Scale: mm) -----	11
3.3 Mounting -----	12
<b>4. Wiring</b> -----	13
4.1 Lead Wire Solderless Terminal -----	13
4.2 Terminal Arrangement	
4.2.1 When Selecting pH Meter -----	14
4.2.2 When Selecting ORP Meter -----	14
<b>5. Key Operation and Setting Groups</b>	
5.1 Outline of Key Operation -----	15
5.2 Setting Groups -----	16
<b>6. Setup</b>	
6.1 Turn the Power Switch ON -----	18
6.2 Model Selection -----	18
6.3 pH Input Group -----	19
6.4 ORP Input Group -----	20
6.5 Temperature Input Group -----	21
6.6 EVT1 Group	
6.6.1 When Selecting pH Meter -----	22
6.6.2 When Selecting ORP Meter -----	26
6.7 EVT2 Group	
6.7.1 When Selecting pH Meter -----	31
6.7.2 When Selecting ORP Meter -----	35
6.8 EVT3 Group	
6.8.1 When Selecting pH Meter -----	40
6.8.2 When Selecting ORP Meter -----	44
6.9 EVT4 Group	
6.9.1 When Selecting pH Meter -----	49
6.9.2 When Selecting ORP Meter -----	53
6.10 Communication Group -----	58
6.11 Transmission Output Group	
6.11.1 When Selecting pH Meter -----	59
6.11.2 When Selecting ORP Meter -----	61
6.12 Cleansing Function Group -----	62
6.13 Special Function Group -----	63
6.14 Zero/Slope Indication Group -----	64
<b>7. Calibration</b>	
7.1 pH Calibration Mode -----	65
7.1.1 Automatic Calibration -----	65
7.1.2 Manual Calibration -----	66
7.1.3 Error Code during pH Calibration -----	68
7.2 Temperature Calibration Mode -----	69
7.3 Adjustment Mode -----	70
7.4 Span Sensitivity Correction Mode -----	71

7.5 Transmission Output 1 Adjustment Mode -----	72
7.6 Transmission Output 2 Adjustment Mode -----	73
<b>8. Measurement</b>	
8.1 Starting Measurement -----	74
8.2 Error Code during Measurement -----	74
8.3 Setting EVT1, EVT2, EVT3, EVT4 Values -----	75
8.4 EVT1, EVT2, EVT3, EVT4 outputs -----	76
8.5 Error Output -----	78
8.6 Fail Output -----	78
8.7 Cleansing Output -----	79
8.8 Manual Cleansing Mode -----	80
8.9 pH/ORP Input Error Alarm -----	80
8.10 Cycle Automatic Variable Function -----	81
8.11 Transmission Output -----	82
<b>9. Specifications</b>	
9.1 Standard Specifications -----	83
9.2 Optional Specifications -----	89
<b>10. Troubleshooting</b>	
10.1 Indication -----	90
10.2 Key Operation -----	92
<b>11 Character Tables</b>	
11.1 Setting Groups -----	93
11.2 pH Calibration Mode (for pH manual calibration) -----	93
11.3 Temperature Calibration Mode -----	93
11.4 Adjustment Mode -----	93
11.5 Span Sensitivity Correction Mode -----	93
11.6 Transmission Output 1 Adjustment Mode -----	94
11.7 Transmission Output 2 Adjustment Mode -----	94
11.8 Simple Setting Mode -----	94
11.9 pH Input Group -----	95
11.10 ORP Input Group -----	95
11.11 Temperature Input Group -----	95
11.12 EVT1 Group (When Selecting pH meter) -----	96
11.13 EVT1 Group (When Selecting ORP meter) -----	97
11.14 EVT2 Group (When Selecting pH meter) -----	99
11.15 EVT2 Group (When Selecting ORP meter) -----	100
11.16 EVT3 Group (When Selecting pH meter) -----	102
11.17 EVT3 Group (When Selecting ORP meter) -----	103
11.18 EVT4 Group (When Selecting pH meter) -----	105
11.19 EVT4 Group (When Selecting ORP meter) -----	106
11.20 Communication Group -----	108
11.21 Transmission Output Group (When Selecting pH meter) -----	108
11.22 Transmission Output Group (When Selecting ORP meter) -----	110
11.23 Cleansing Function Group -----	111
11.24 Special Function Group -----	111
11.25 Zero/Slope Indication Group -----	111
<b>12. Key Operation Flowchart</b> -----	112

# 1. Model

## 1.1 Model

F E B - 1 0	2	-PH		, □□□	
Input Points	2				2 points
Input		PH			pH Combined Electrode Sensor (Cu500/25°C, Pt100 or Pt1000) ORP Combined Electrode Sensor (*1)
Supply Voltage					100 to 240 V AC
Option			C5		Serial communication RS-485 (*2)
			EVT3		EVT3 output (Contact output 3) (*3)
			EVT4		EVT3, EVT4 output (Contact outputs 3, 4) (*2)

(\*1) Available when **ORP**□□□ (ORP meter) is selected in Section 6.2 Model Selection (p.18).

(\*2) If C5 or EVT4 option is ordered, Transmission output 1 and 2 are not available.

(\*3) If EVT3 is ordered, Transmission output 1 is not available.

## 1.2 How to Read the Model Label

The model label is attached on the inside of the cover.

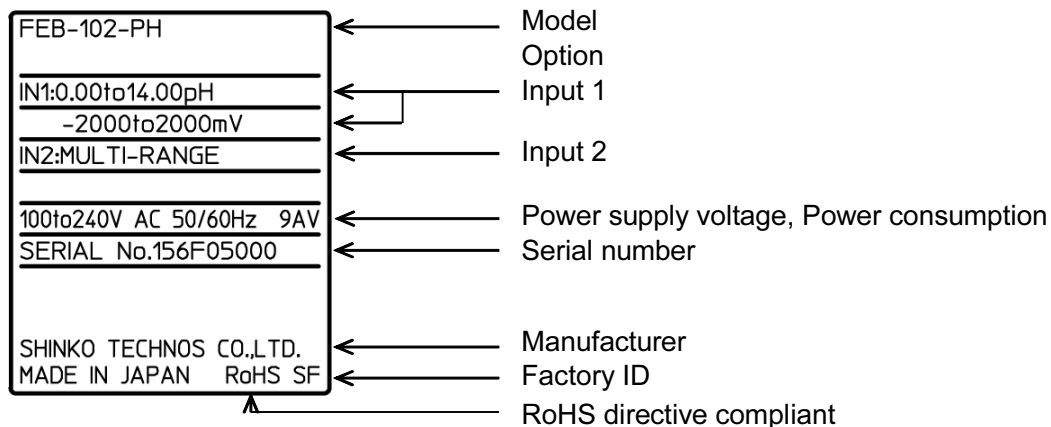

(Fig. 1.2-1)

## 2. Names and Functions of Sections

### 2.1 Main Body of FEB-102-PH

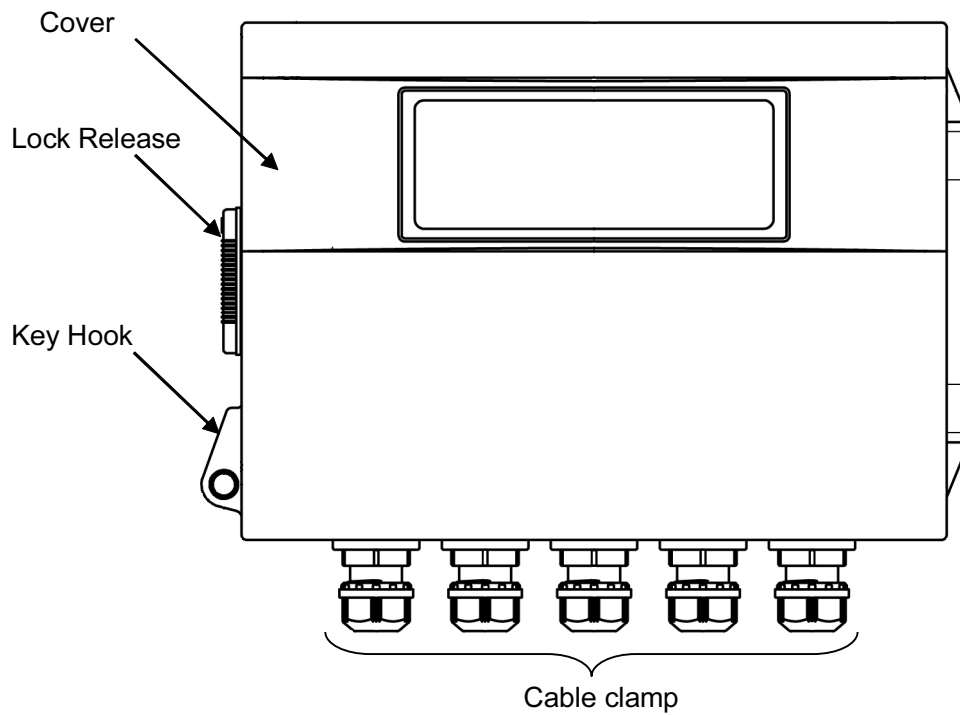

(Fig. 2.1-1)

### 2.2 How to Open the Cover

#### 2.2.1 Open the Cover

(1) Push the Lock Release up to unlock it.

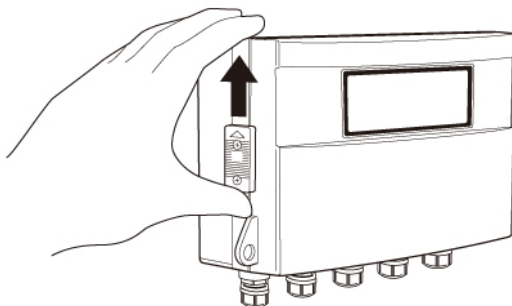

(Fig. 2.2.1-1)

(2) Pull the cover toward you to open it.

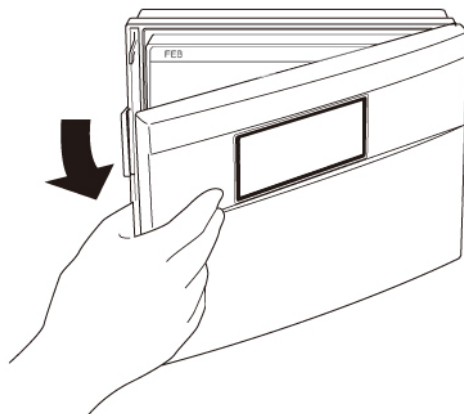

(Fig. 2.2.1-2)



## 2.2.2 Close the Cover

(1) Close the cover tightly by pushing firmly until no gap remains between the body and cover.

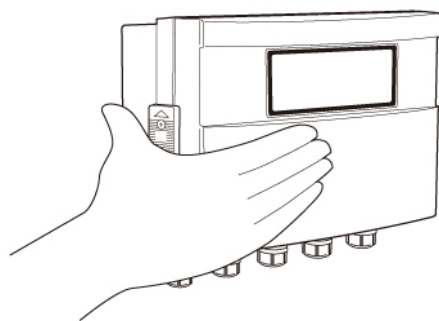

(Fig. 2.2.2-1)

(2) Lock the unit by pulling the Lock Release down completely.



### Caution

- Confirm that the Lock Release is securely locked.  
If it is not locked, Drip-proof/Dust-proof specification (IP65) may be compromised.

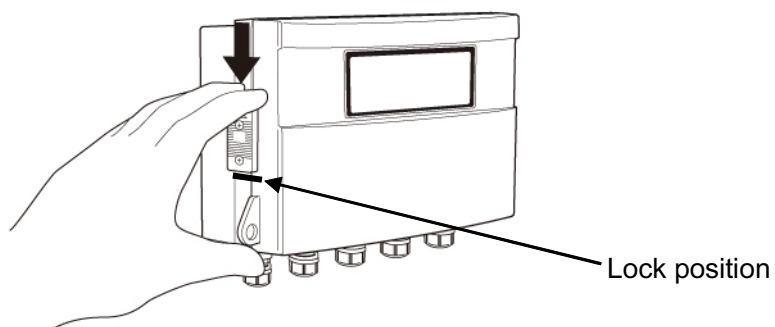

(Fig. 2.2.2-2)

## 2.3 Display and Operation Panel

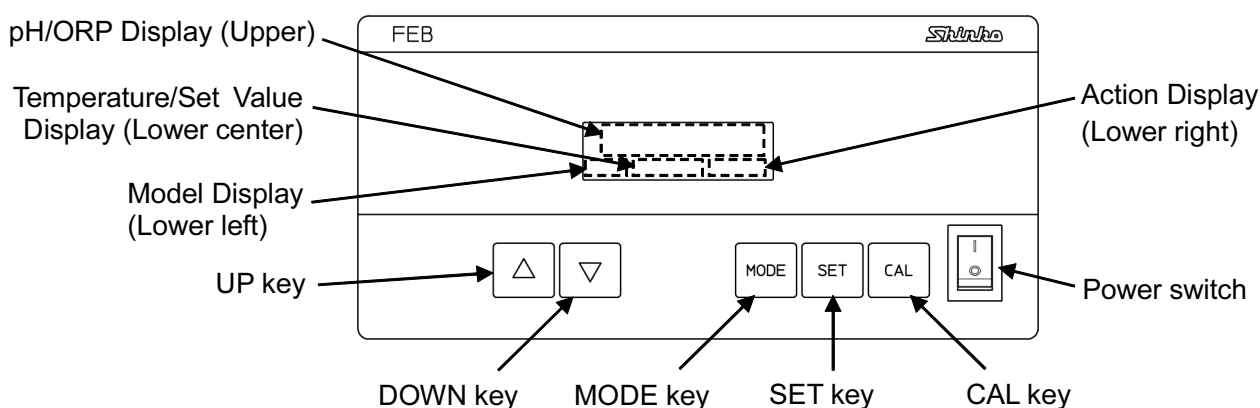

(Fig. 2.3-1)

### pH/ORP Display (Upper), Temperature/Set Value Display (Lower center):

In pH-Temperature/ORP Display Mode or Cleansing Output Mode, the following is indicated depending on the selection in Section 6.2 Model Selection (p.18).

Model Selection	pH/ORP Display	Temperature/Set Value Display
pH meter	pH	Temperature
ORP meter	ORP	Unlit

In Setting mode or Calibration mode, the pH/ORP Display indicates a setting item or calibration item, and the Temperature/Set Value Display indicates a set value or calibration value.

Indication differs depending on the selection in [Display selection (pH/ORP meter)]. (pp.63, 64)

### Model Display (Lower left)

Indicates a model as follows:

**[PH ]**: Indicated when **PH** (pH meter) is selected in Section 6.2 Model Selection (p.18),

**[ORP ]**: Indicated when **ORP** (ORP meter) is selected in Section 6.2 Model Selection (p.18),

### Action Display (Lower right)

EV1: Indicated when EVT1 output (Contact output 1) is ON.

EV2: Indicated when EVT2 output (Contact output 2) is ON.

EV3: Indicated when EVT3 output (Contact output 3) is ON.

(When EVT3 option or EVT4 option is ordered)

EV4: Indicated when EVT4 output (Contact output 4) is ON (When EVT4 option is ordered).

T/R: Indicated while in Serial communication TX output (transmitting) (When C5 option is ordered).

### Keys

- UP key: Increases the numeric value.
- DOWN key: Decreases the numeric value, or selects a group.
- MODE key: Moves to the group selection, or reverts to pH-Temperature/ORP Display Mode, or Cleansing Output Mode from the setting item.
- SET key: Switches the setting modes, and registers the set value.
- CAL key: Moves to the following mode depending on the selection in Section 6.2 Model Selection (p.18).

Model Selection	CAL key	UP key + CAL key
pH meter	pH Calibration Mode	Temperature Calibration Mode
ORP meter	Adjustment Mode	Span Sensitivity Correction Mode

### Switch

- Power switch: Turns the power to the instrument ON/OFF.
  - : Turns ON.
  - : Turns OFF.

# 3. Mounting

## 3.1 Site Selection

**⚠ Caution**

Use within the following temperature and humidity ranges.  
 Temperature: -20 to 50°C (-4 to 122°F) (No icing), Humidity: 35 to 95%RH (Non-condensing)  
 The ambient temperature of the unit must be kept to under 50°C. Otherwise the life of electronic parts (especially electrolytic capacitors) of the unit will be shortened.

**This instrument is intended to be used under the following environmental conditions (IEC61010-1): Overvoltage category II, Pollution degree 2**

Ensure the mounting location corresponds to the following conditions:

- A minimum of dust, and an absence of corrosive gases
- No flammable, explosive gases
- No mechanical vibrations or shocks
- No exposure to direct sunlight, an ambient temperature of -20 to 50°C (-4 to 122°F) that does not change rapidly
- An ambient non-condensing humidity of 35 to 95%RH
- No large capacity electromagnetic switches or cables through which large current is flowing
- No water, oil or chemicals or where the vapors of these substances can come into direct contact with the unit

## 3.2 External Dimensions (Scale: mm)

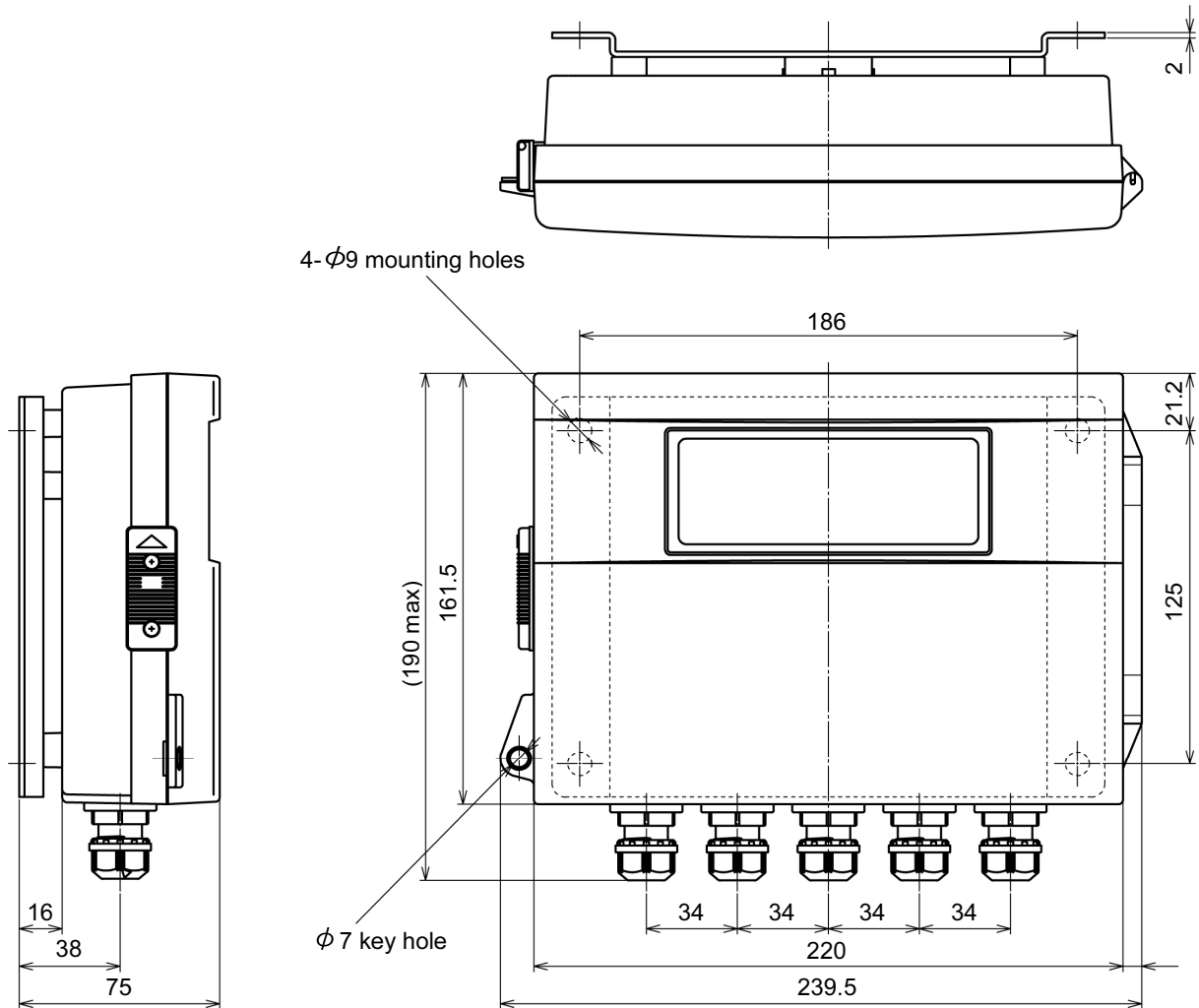

(Fig. 3.2-1)

### 3.3 Mounting

- (1) Fix the mounting bracket to the wall.

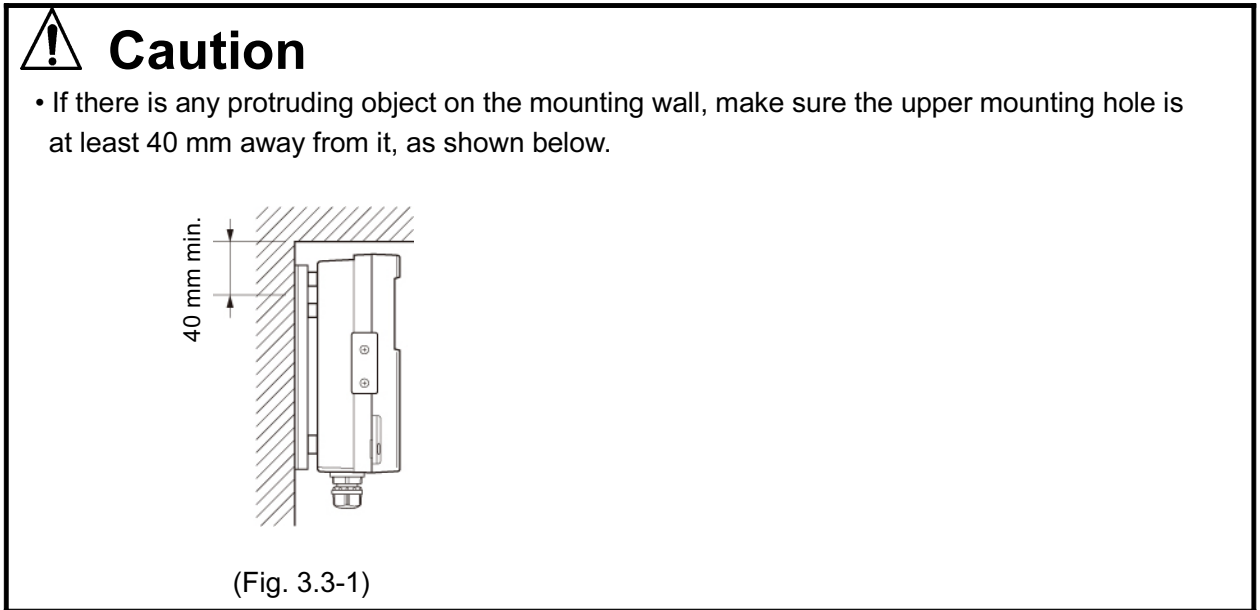

- (2) Hook this instrument on the stud of the mounting bracket.
- (3) Open the cover and the terminal cover, and mount the instrument with the provided screws.

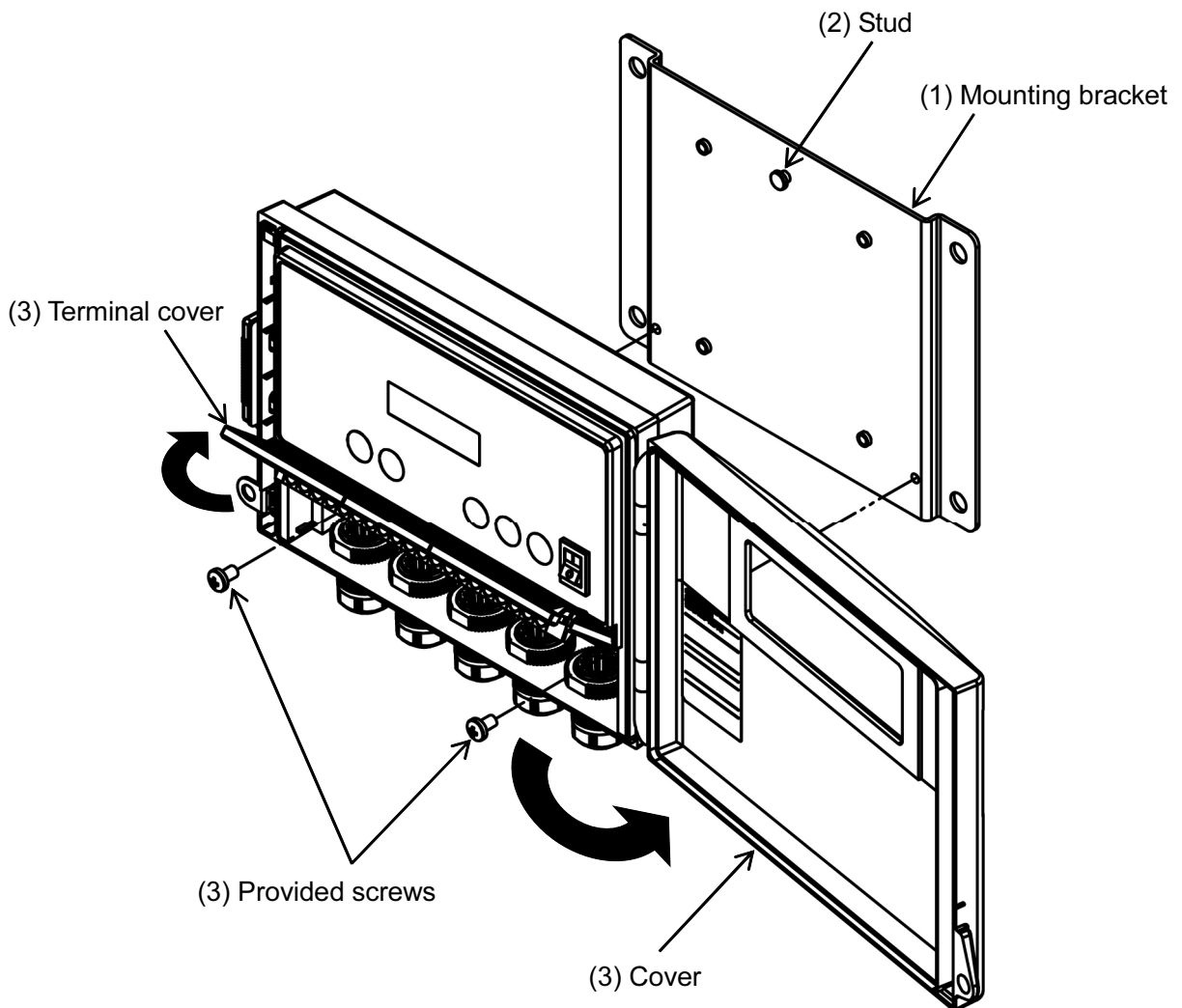

(Fig. 3.3-2)

# 4. Wiring

## Warning

Turn the power supply to the instrument OFF before wiring or checking.  
Working on or touching the terminal with the power switched on may result in severe injury or death due to electrical shock.

## Caution

- Use a ring-type solderless terminal with an insulation sleeve in which the M3 screw fits when wiring the unit.
- Tighten the terminal screw using the specified torque. If excessive force is applied to the screw when tightening, the terminal screw may be damaged.
- This instrument does not have a built-in power switch, circuit breaker and fuse. It is necessary to install a power switch, circuit breaker and fuse near the instrument. (Recommended fuse: Time-lag fuse, rated voltage 250 V AC, rated current 2 A)
- Do not apply a commercial power source to the sensor which is connected to the input terminals nor allow the power source to come into contact with the sensor.
- Use the pH/ORP Combined Electrode Sensor in accordance with the sensor input specifications of this instrument.
- Keep the sensor cables and power cables in separate groups, do not put them in the same cable clamp.

### Note about the pH/ORP Combined Electrode Sensor Cable

The pH/ORP Combined Electrode Sensor cable is a highly-insulated (electrical) cable. Please handle it with utmost care as follows.

- Do not allow terminals and socket of the pH/ORP Combined Electrode Sensor cable to come in contact with moisture or oil of any kind. Likewise, ensure fingers are clean, otherwise the insulation will deteriorate, resulting in unstable indication. Be sure to keep the cable dry and clean at all times. If the cable is stained, clean it with alcohol, and dry it completely.
- For calibration or electrode checking/replacement, the pH/ORP Combined Electrode Sensor cable should be wired with sufficient length.
- Keep the pH/ORP Combined Electrode Sensor cable and junction cable away from electrical devices, such as motors or their power lines from which inductive interference emanates.

### Connection

The pH Combined Electrode Sensor cable has the following terminals.

Symbol	Terminal
G	Glass electrode terminal
R	Reference electrode terminal
T, T	Temperature compensation electrode terminals (Cu500)
A, B, B	Temperature compensation electrode terminals (Pt100 or Pt1000)
E	Shield wire terminal

For the pH Combined Electrode Sensor with no temperature compensation, T, T or A, B, B cables are not available.

E cables are available depending on the sensor type.

The ORP Combined Electrode Sensor cable has the following terminals.

Symbol	Terminal
M	Metal electrode terminal
R	Reference electrode terminal

### 4.1 Lead Wire Solderless Terminal

Use a ring-type solderless terminal with an insulation sleeve in which an M3 screw fits as follows.

The tightening torque should be 0.5 N•m.

Solderless Terminal	Manufacturer	Model
Ring-type	Nichifu Terminal Industries CO.,LTD.	TMEV1.25-3
	Japan Solderless Terminal MFG CO.,LTD.	V1.25-3

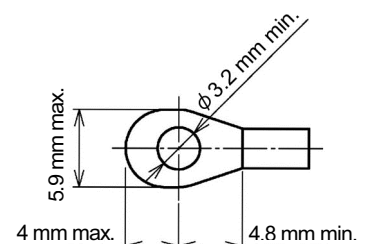

(Fig. 4.1-1)

## 4.2 Terminal Arrangement

Terminal arrangement differs depending on the selection in Section 6.2 Model Selection (p.18).

### 4.2.1 When Selecting pH Meter

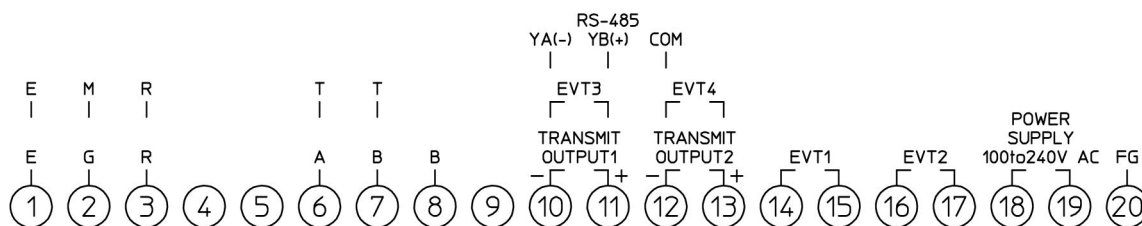

(Fig. 4.2.1-1)

- E: pH Combined Electrode Sensor Shield wire terminal (①)
- G, R: pH Combined Electrode Sensor Electrode sensor terminals (② - ③)
- T, T: Temperature element: Cu500 (2-wire) Temperature compensation sensor terminals (⑥ - ⑦)
- A, B: Temperature element: Pt100 (2-wire), Pt1000 (2-wire) Temperature compensation sensor terminals (⑥ - ⑦)
- A, B, B: Temperature element: Pt100 (3-wire)  
Temperature compensation sensor terminals (⑥ - ⑦ - ⑧)
- TRANSMIT OUTPUT1: Transmission output 1 terminals (⑩ - ⑪)  
(Not available if C5, EVT3 or EVT4 option is ordered)
- TRANSMIT OUTPUT2: Transmission output 2 terminals (⑫ - ⑬)  
(Not available if C5 or EVT4 option is ordered.)
- EVT1: EVT1 output (Contact output 1) terminals (⑭ - ⑮)
- EVT2: EVT2 output (Contact output 2) terminals (⑯ - ⑰)
- EVT3: EVT3 output (Contact output 3) terminals (⑩ - ⑪) (When EVT3 or EVT4 option is ordered)
- EVT4: EVT4 output (Contact output 4) terminals (⑩ - ⑪) (When EVT4 option is ordered)
- RS-485: Serial communication terminals (⑩ - ⑪ - ⑫) (When C5 option is ordered)
- POWER SUPPLY: Power terminals (⑱ - ⑲)
- FG: Ground terminals (⑳)

### 4.2.2 When Selecting ORP Meter

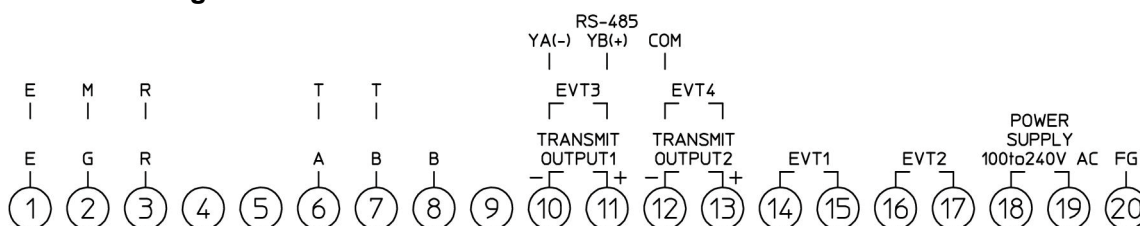

(Fig. 4.2.2-1)

- E: ORP Combined Electrode Sensor Shield wire terminals (①)
- M, R: ORP Combined Electrode Sensor Electrode sensor terminals (② - ③)
- TRANSMIT OUTPUT1: Transmission output 1 terminals (⑩ - ⑪)  
(Not available if C5, EVT3, EVT4 option is ordered)
- TRANSMIT OUTPUT2: Transmission output 2 terminals (⑫ - ⑬)  
(Not available if C5 or EVT4 option is ordered.)
- EVT1: EVT1 output (Contact output 1) terminals (⑭ - ⑮)
- EVT2: EVT2 output (Contact output 2) terminals (⑯ - ⑰)
- EVT3: EVT3 output (Contact output 3) terminals (⑩ - ⑪) (When EVT3 or EVT4 option is ordered)
- EVT4: EVT4 output (Contact output 4) terminals (⑩ - ⑪) (When EVT4 option is ordered)
- RS-485: Serial communication terminals (⑩ - ⑪ - ⑫) (When C5 option is ordered)
- POWER SUPPLY: Power terminals (⑱ - ⑲)
- FG: Ground terminals (⑳)

# 5. Key Operation and Setting Groups

## 5.1 Outline of Key Operation

There are Simple Setting Mode, and Group Selection Mode into which setting items are divided.

To enter Simple Setting Mode, press the  key in pH-Temperature/ORP Display Mode or Cleansing Output Mode.

To enter Group Selection Mode, press the  key in pH-Temperature/ORP Display Mode or Cleansing Output Mode.

Select a group with the  key, then press the  key. The unit will move to the each setting item.

Make settings with the  key or  key, and register settings with the  key.

By pressing the  key in Simple Setting Mode, Group Selection Mode or at any setting item, the unit reverts to pH-Temperature/ORP Display Mode, or Cleansing Output Mode.

## 5.2 Setting Groups

Abbreviations:  
Sens.: Sensitivity  
Adjust: Adjustment

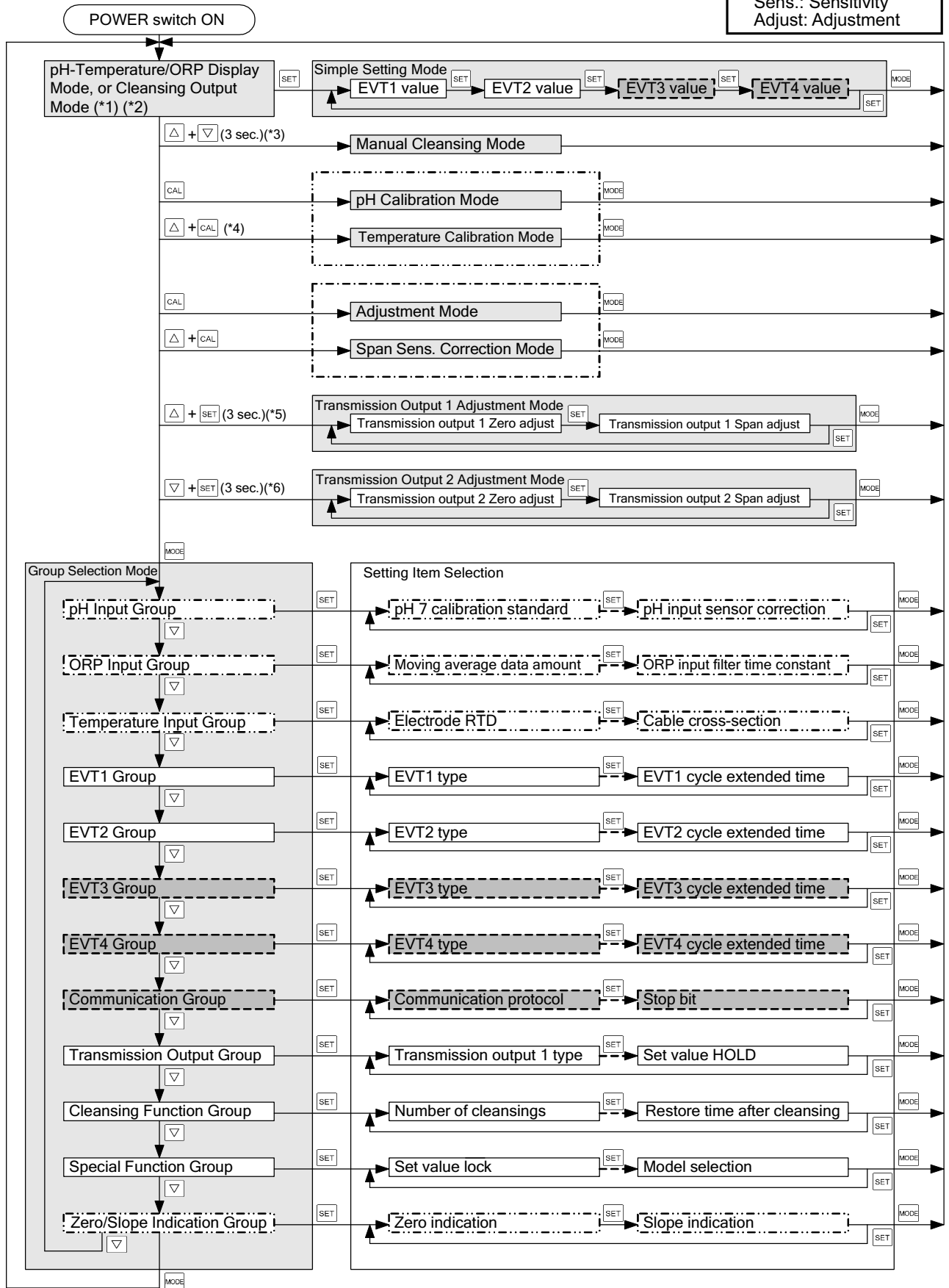





## About Each Mode and Setting Items

(\*1) In pH-Temperature/ORP Display Mode or Cleansing Output Mode, indicates an item selected in [Display selection (for pH meter)] or in [Display selection (for ORP meter)] (pp. 63, 64).

When the power switch is turned ON again, the last mode (pH-Temperature/ORP Display Mode, or Cleansing Output Mode) from when the power switch was turned OFF will resume.

(\*2) If the  key is pressed for approx. 3 seconds in pH-Temperature/ORP Display Mode, or Cleansing Output Mode, the unit will be switched to voltage indication.

By pressing the  key, the unit reverts to pH-Temperature/ORP Display Mode or Cleansing Output Mode.

(\*3) If **CLEG** (Cleansing output) is selected in [EVT1, EVT2, EVT3 or EVT4 type (pp. 22, 26, 31, 35, 40, 44, 49, 53)], the unit can enter the Manual Cleansing Mode.

After the cleansing action is completed, the unit automatically reverts to the Cleansing Output Mode.



(\*4) If **NONE** (No temperature compensation) is selected in [Electrode RTD (p.21)], the unit will not enter Temperature Calibration mode.

(\*5) If C5, EVT3 or EVT4 option is ordered, the unit will not move to Transmission Output 1 Adjustment Mode.





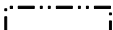





















(\*6) If C5 or EVT4 option is ordered, the unit will not move to Transmission Output 2 Adjustment Mode.

: Available only when option is ordered.

: Available when **ORP** (ORP meter) is selected in Section 6.2 Model Selection (p.18).

: Available when **PH** (pH meter) is selected in Section 6.2 Model Selection (p.18).

## Key Operation

-     : If the , ,  or  key is pressed, the unit will proceed to the next setting item, illustrated by an arrow.
-  : Press the  key until the desired setting mode appears.
-  +  (3 sec) : Press and hold the  and  keys (in that order) together for 3 seconds. The unit will proceed to Manual Cleansing Mode.
-  +  : Press and hold the  and  keys (in that order) together. The unit will proceed to Temperature Calibration Mode (pH meter) or Span Sensitivity Correction Mode (ORP meter).
-  +  (3 sec) : Press and hold the  and  keys (in that order) together for 3 seconds. The unit will proceed to Transmission Output 1 Adjustment Mode.
-  +  (3 sec) : Press and hold the  and  keys (in that order) together for 3 seconds. The unit will proceed to Transmission Output 2 Adjustment Mode.
- If the  key is pressed at each setting item, the unit will revert to pH-Temperature/ORP Display Mode, or Cleansing Output Mode.

# 6. Setup

Setup should be done before using this instrument according to the user's conditions:

Setting pH or ORP input, Temperature input, EVT1 to EVT4 types, Communication, Transmission output, Cleansing output, Display setting, etc.

If the user's specification is the same as the factory default value of this instrument, or if user's instrument has already been installed in a system after setup has been completed, initial settings are not necessary. Proceed to Section '7. Calibration' (p.65).

The following outlines the procedure for setup (initial settings).

- (1) Model selection [Section 6.2 Model Selection]
- (2) pH or ORP input [Sections 6.3 pH Input Group, 6.4 ORP Input Group (pp.19, 20)]
- (3) Temperature input [Section 6.5 Temperature Input Group (p.21)]

Set the following items if required.

- (4) EVT1 to EVT4 types [Sections 6.6 EVT1 Group to 6.9 EVT4 Group (pp. 22 to 57)]
- (5) Communication function [Section 6.10 Communication Group (p.58)]
- (6) Transmission output function [Section 6.11 Transmission Output Group (pp. 59 to 62)]
- (7) Cleansing function [Section 6.12 Cleansing Function Group (p.62)]
- (8) Special function [Section 6.13 Special Function Group (pp. 63, 64)]

## 6.1 Turn the Power Switch ON

For approx. 4 seconds after the power is switched ON, the input type is indicated in the pH/ORP Display and Temperature/Set Value Display.

pH/ORP Display	Temperature/ Set Value Display	Item selected in Section 6.2 Model Selection	Item selected in [Electrode RTD (p.21)]
pH <input type="text"/>	Unlit	pH <input type="text"/> : pH meter	NONE <input type="text"/> : No temperature compensation
	CU500 <input type="text"/>		CU500 <input type="text"/> : Cu500
	PT100 <input type="text"/>		PT100 <input type="text"/> : Pt100
	PT1000 <input type="text"/>		PT1000 <input type="text"/> : Pt1000
ORP <input type="text"/>	Unlit	ORP <input type="text"/> : ORP meter	

After that, measurement starts, indicating an item selected in [Display selection (for pH meter)] or [Display selection (for ORP meter)] (pp. 63, 64).

This status is called pH-Temperature/ORP Display Mode, or Cleansing Output Mode.

## 6.2 Model Selection

Model can be selected in Special Function Group.

To enter the Special Function Group, follow the procedure below.

- ① **G\_PH**  Press the  key in pH-Temperature/ORP Display Mode or Cleansing Output Mode.
- ② **G\_OTH**  Press the  key as many times as necessary until the left characters appear.
- ③ **MODEL**  Press the  key as many times as necessary until the left characters appear.

The unit will enter the Special Function Group, and 'Model selection' will appear.

Character	Setting Item, Function, Setting Range	Factory Default
<b>MODEL</b> pH <input type="text"/>	<b>Model selection</b> • Selects either pH meter or ORP meter. • pH <input type="text"/> : pH meter • ORP <input type="text"/> : ORP meter	pH meter

- ④ Press the  key.

The unit will revert to pH-Temperature/ORP Display Mode or Cleansing Output Mode.

### 6.3 pH Input Group

Not available if **ORP** (ORP meter) is selected in Section 6.2 Model Selection (p.18).

To enter the pH Input Group, follow the procedure below.

- ① **G.PH** Press the **MODE** key in pH-Temperature/ORP Display Mode, or Cleansing Output Mode.
- ② **TYPE** Press the **SET** key.

The unit will proceed to the pH Input Group, and 'pH 7 calibration standard' will appear.

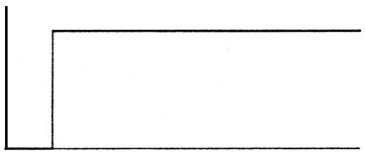
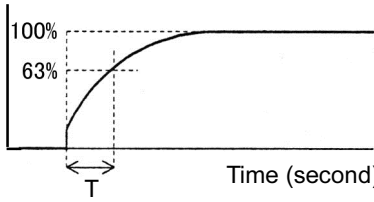
Character	Setting Item, Function, Setting Range	Factory Default
<b>TYPE</b> <b>JIS</b>	<b>pH 7 calibration standard</b> <ul style="list-style-type: none"> <li>• Selects the pH 7 calibration value standard.</li> <li>• Available when <b>AUTO</b> (Automatic) is selected in [pH calibration Auto/Manual]</li> <li>• <b>JIS</b> : JIS (Japanese Industrial Standards)</li> <li>• <b>US</b> : US standard</li> </ul>	JIS
<b>SEPH</b> <b>pH4</b>	<b>2nd solution</b> <ul style="list-style-type: none"> <li>• Selects the 2nd solution for the automatic pH calibration from pH 2, pH 4, pH 9, pH 10 (JIS).</li> <li>[The 1st solution is fixed at pH 7 (JIS or US standard).]</li> <li>• Not available if <b>MANU</b> (Manual) is selected in [pH calibration Auto/Manual].</li> <li>• <b>pH2</b> : pH 2</li> <li>• <b>pH4</b> : pH 4</li> <li>• <b>pH9</b> : pH 9</li> <li>• <b>pH10</b> : pH 10</li> <li>(JIS: Japanese Industrial Standards)</li> </ul>	pH 4
<b>AJST</b> <b>AUTO</b>	<b>pH calibration Auto/Manual</b> <ul style="list-style-type: none"> <li>• Selects either automatic or manual pH calibration.</li> <li>• <b>AUTO</b> : Automatic</li> <li>• <b>MANU</b> : Manual</li> </ul>	Automatic
<b>DP1</b> <b>0.00</b>	<b>Decimal point place</b> <ul style="list-style-type: none"> <li>• Selects the decimal point place.</li> <li>• <b>0</b> : No decimal point</li> <li>• <b>0.0</b> : 1 digit after decimal point</li> <li>• <b>0.00</b> : 2 digits after decimal point</li> </ul>	2 digits after decimal point
<b>DFCT</b> <b>3</b>	<b>Moving average data amount</b> <ul style="list-style-type: none"> <li>• Sets the number of pH inputs for calculating the moving average.</li> <li>• Setting range: 1 to 20</li> </ul>	3
<b>FILT</b> <b>0.0</b>	<b>pH input filter time constant</b> <ul style="list-style-type: none"> <li>• Sets pH input filter time constant.</li> <li>Even when the pH measurement value changes as shown in (Fig. 6.3-1), if the filter time constant "T" is set, the pH measurement value changes so that it can reach 63% of the pH measurement value in T seconds as shown in (Fig. 6.3-2).</li> <li>If the value is set too large, it adversely affects EVT action due to the delay of response.</li> <li>(e.g.) If the lowest digit of the pH measurement value before filtering process is fluctuating, the fluctuation can be suppressed by using the filter time constant.</li> </ul> <div style="display: flex; justify-content: space-around; align-items: flex-end;"> <div style="text-align: center;">  <p>(Fig. 6.3-1)</p> </div> <div style="text-align: center;">  <p>(Fig. 6.3-2)</p> </div> </div> <ul style="list-style-type: none"> <li>• Setting range: 0.0 to 60.0 seconds</li> </ul>	0.0 sec.

Character	Setting Item, Function, Setting Range	Factory Default
PS0 <input type="text"/> <input type="text"/> 0.00	<b>pH input sensor correction</b> <ul style="list-style-type: none"> <li>Sets pH input sensor correction value.</li> <li>This corrects the measured value from the pH Combined Electrode Sensor. When a sensor cannot be set at the exact location where measurement is desired, the sensor-measured pH value may deviate from the pH in the measured location. In this case, the desired pH can be obtained by adding a sensor correction value.</li> <li>However, it is effective within the measurement range regardless of the sensor correction value.</li> <li>pH value after sensor correction = Current pH value + (Sensor correction value)</li> <li>Setting range: pH -1.40 to 1.40 (*)</li> </ul>	0.00

(\*) The placement of the decimal point does not follow the selection. It is fixed.

#### 6.4 ORP Input Group

Not available if **PH**  (pH meter) is selected in Section 6.2 Model Selection (p.18).

To enter the ORP Input Group, follow the procedure below.

- ① **G\_ORP** Press the MODE key in pH-Temperature/ORP Display Mode, or Cleansing Output Mode.
- ② **DFCT** Press the SET key.

The unit will proceed to the ORP Input Group, and 'Moving average data amount' will appear.

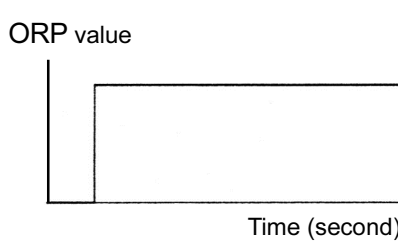
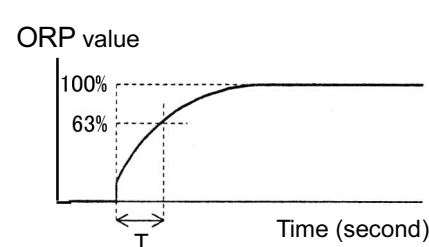
Character	Setting Item, Function, Setting Range	Factory Default
DFCT <input type="text"/> <input type="text"/> 3	<b>Moving average data amount</b> <ul style="list-style-type: none"> <li>Sets the number of ORP inputs for calculating the moving average.</li> <li>Setting range: 1 to 20</li> </ul>	3
DSPH <input type="text"/> <input type="text"/> 2000	<b>Input high limit</b> <ul style="list-style-type: none"> <li>Sets the high limit value for ORP input indication.</li> <li>Setting range: Input low limit value to 2000 mV</li> </ul>	2000 mV
DSPL <input type="text"/> <input type="text"/> -2000	<b>Input low limit</b> <ul style="list-style-type: none"> <li>Sets the low limit value for ORP input indication.</li> <li>Setting range: -2000 mV to Input high limit value</li> </ul>	-2000 mV
FILT <input type="text"/> <input type="text"/> 0.0	<b>ORP input filter time constant</b> <ul style="list-style-type: none"> <li>Sets ORP input filter time constant.</li> <li>Even when the ORP measurement value changes as shown in (Fig. 6.4-1), if the filter time constant "T" is set, the ORP measurement value changes so that it can reach 63% of the ORP measurement value in T seconds as shown in (Fig. 6.4-2).</li> <li>If the value is set too large, it adversely affects EVT action due to the delay of response.</li> <li>(e.g.) If the lowest digit of the ORP value before filtering process is fluctuating, the fluctuation can be suppressed by using the filter time constant.</li> </ul> <div style="display: flex; justify-content: space-around; align-items: flex-end;"> <div style="text-align: center;">  <p>(Fig. 6.4-1)</p> </div> <div style="text-align: center;">  <p>(Fig. 6.4-2)</p> </div> </div> <ul style="list-style-type: none"> <li>Setting range: 0.0 to 60.0 seconds</li> </ul>	0.0 sec.

## 6.5 Temperature Input Group

Not available if **ORP** (ORP meter) is selected in Section 6.2 Model Selection (p.18).

To enter the Temperature Input Group, follow the procedure below.

- ① **G.PH** Press the **MODE** key in pH-Temperature/ORP Display Mode, or Cleansing Output Mode.
- ② **G.TMP** Press the **▽** key in the pH Input Group.
- ③ **SENS** Press the **SET** key.

The unit will enter the Temperature Input Group, and 'Electrode RTD' will appear.

Character	Setting Item, Function, Setting Range	Factory Default
<b>SENS</b> <b>PT100</b>	<b>Electrode RTD</b> • Selects RTD type of the electrode. • <b>NONE</b> : No temperature compensation <b>CU500</b> : Cu500 <b>PT100</b> : Pt100 <b>PT1000</b> : Pt1000	Pt100
<b>STND</b> <b>25.0</b>	<b>Reference temperature</b> • Sets the reference temperature for temperature compensation. • If <b>NONE</b> (No temperature compensation) is selected in [Electrode RTD], the temperature set in [Reference temperature] will be indicated in the Temperature/Set Value Display. • Setting range: 5.0 to 95.0°C (*)	25.0°C
<b>DP2</b> <b>0.0</b>	<b>Decimal point place</b> • Selects decimal point place. • <b>0</b> : No decimal point <b>0.0</b> : 1 digit after decimal point	1 digit after decimal point
<b>CNECT</b> <b>3WIRE</b>	<b>Pt100 input wire type</b> • Selects the input wire type when <b>PT100</b> (Pt100) is selected in [Electrode RTD]. • Available only when <b>PT100</b> (Pt100) is selected in [Electrode RTD]. • <b>2WIRE</b> : 2-wire type <b>3WIRE</b> : 3-wire type	3-wire type
<b>CABLE</b> <b>0.0</b>	<b>Cable length correction</b> • Sets the cable length correction value. • Available when <b>PT100</b> (Pt100) is selected in [Electrode RTD]. Available when <b>2WIRE</b> (2-wire type) is selected in [Pt100 input wire type]. • Setting Range: 0.0 to 100.0 m	0.0 m
<b>CSEC</b> <b>0.30</b>	<b>Cable cross-section area</b> • Sets the cable cross-section area. • Available when <b>PT100</b> (Pt100) is selected in [Electrode RTD]. Available when <b>2WIRE</b> (2-wire type) is selected in [Pt100 input wire type]. • Setting Range: 0.10 to 2.00 mm <sup>2</sup>	0.30 mm <sup>2</sup>

(\*) The placement of the decimal point does not follow the selection. It is fixed.

## 6.6 EVT1 Group

Setting item and range differ depending on the selection in Section 6.2 Model Selection (p.18).

### 6.6.1 When Selecting pH Meter

To enter EVT1 Group, follow the procedure below.

- ① **G\_PH** Press the  key in pH-Temperature/ORP Display Mode, or Cleansing Output Mode.
- ② **G\_E01** Press the  key as many times as necessary until the left characters appear.
- ③ **EVT1F** Press the  key.

The unit will enter EVT1 Group, and 'EVT1 type' will appear.

Character	Setting Item, Function, Setting Range	Factory Default																														
<b>EVT1F</b> -----	<b>EVT1 type</b> <ul style="list-style-type: none"> <li>Selects an EVT1 output (Contact output 1) type. (Fig. 6.6-1) (p.30)</li> <li><b>Note: If EVT1 type is changed, EVT1 value will default to 0.00 or 0.0.</b></li> <li>If <b>NONE</b> (No temperature compensation) is selected in [Electrode RTD (p.21)], and even if Temperature input low limit or high limit action is selected, the action will be disabled.</li> <li>-----: No action</li> <li><b>PH_L</b> : pH input low limit action</li> <li><b>PH_H</b> : pH input high limit action</li> <li><b>TEMPL</b> : Temperature input low limit action</li> <li><b>TEMPH</b> : Temperature input high limit action</li> <li><b>EROUT</b> : Error output [When the error type is "Error" (Table 6.6.1-1), the output is turned ON.]</li> <li><b>FAIL</b> : Fail output [When the error type is "Fail" (Table 6.6.1-1), the output is turned ON.]</li> <li><b>CLEG</b> : Cleansing output</li> <li><b>EPUL</b> : pH input error alarm output</li> </ul> <b>• Error output, Fail output (Table 6.6.1-1)</b> <table border="1"> <thead> <tr> <th>Error Type</th> <th>Error Contents</th> <th>Description</th> </tr> </thead> <tbody> <tr> <td>Error</td> <td>Response Speed Error</td> <td>When calibrating, the response of the pH Combined Electrode Sensor is slow. With the 1st and 2nd solutions, when pH <math>\pm 0.10</math> or more of input fluctuation within pH <math>\pm 1.50</math> continues for 5 minutes.</td> </tr> <tr> <td>Error</td> <td>Electrode Sensitivity Error</td> <td>When calibrating, sensitivity of the pH Combined Electrode Sensor is deteriorating. The difference of pH measured value (after calibration) between the 1st and the 2nd point is pH 2.00 or less.</td> </tr> <tr> <td>Error</td> <td>Asymmetry Potential Error</td> <td>When calibrating pH 7, the difference in electromotive force between the sensor-measured value and standard value exceeds the equivalent of pH <math>\pm 1.50</math>.</td> </tr> <tr> <td>Error</td> <td>Standard Solution Error</td> <td>The specified standard solution has not been used. When pH <math>\pm 1.50</math> is exceeded for the 1st &amp; 2nd solutions.</td> </tr> <tr> <td>Error</td> <td>Solution Temperature Error</td> <td>When temperature is 55°C or more at pH 10 solution.</td> </tr> <tr> <td>Error</td> <td>Outside Temp. Compen. Range</td> <td>Measured temperature has exceeded 110.0°C.</td> </tr> <tr> <td>Error</td> <td>Outside Temp. Compen. Range</td> <td>Measured temperature is less than 0.0°C.</td> </tr> <tr> <td>Fail</td> <td>Temp. Sensor Burnout</td> <td>Temperature sensor lead wire is burnt out.</td> </tr> <tr> <td>Fail</td> <td>Temp. Sensor Short-circuited</td> <td>Temperature sensor lead wire is short-circuited.</td> </tr> </tbody> </table> <p>(Abbreviations: Temp.: Temperature, Compen.: Compensation)</p>	Error Type	Error Contents	Description	Error	Response Speed Error	When calibrating, the response of the pH Combined Electrode Sensor is slow. With the 1st and 2nd solutions, when pH $\pm 0.10$ or more of input fluctuation within pH $\pm 1.50$ continues for 5 minutes.	Error	Electrode Sensitivity Error	When calibrating, sensitivity of the pH Combined Electrode Sensor is deteriorating. The difference of pH measured value (after calibration) between the 1st and the 2nd point is pH 2.00 or less.	Error	Asymmetry Potential Error	When calibrating pH 7, the difference in electromotive force between the sensor-measured value and standard value exceeds the equivalent of pH $\pm 1.50$ .	Error	Standard Solution Error	The specified standard solution has not been used. When pH $\pm 1.50$ is exceeded for the 1st & 2nd solutions.	Error	Solution Temperature Error	When temperature is 55°C or more at pH 10 solution.	Error	Outside Temp. Compen. Range	Measured temperature has exceeded 110.0°C.	Error	Outside Temp. Compen. Range	Measured temperature is less than 0.0°C.	Fail	Temp. Sensor Burnout	Temperature sensor lead wire is burnt out.	Fail	Temp. Sensor Short-circuited	Temperature sensor lead wire is short-circuited.	No action
Error Type	Error Contents	Description																														
Error	Response Speed Error	When calibrating, the response of the pH Combined Electrode Sensor is slow. With the 1st and 2nd solutions, when pH $\pm 0.10$ or more of input fluctuation within pH $\pm 1.50$ continues for 5 minutes.																														
Error	Electrode Sensitivity Error	When calibrating, sensitivity of the pH Combined Electrode Sensor is deteriorating. The difference of pH measured value (after calibration) between the 1st and the 2nd point is pH 2.00 or less.																														
Error	Asymmetry Potential Error	When calibrating pH 7, the difference in electromotive force between the sensor-measured value and standard value exceeds the equivalent of pH $\pm 1.50$ .																														
Error	Standard Solution Error	The specified standard solution has not been used. When pH $\pm 1.50$ is exceeded for the 1st & 2nd solutions.																														
Error	Solution Temperature Error	When temperature is 55°C or more at pH 10 solution.																														
Error	Outside Temp. Compen. Range	Measured temperature has exceeded 110.0°C.																														
Error	Outside Temp. Compen. Range	Measured temperature is less than 0.0°C.																														
Fail	Temp. Sensor Burnout	Temperature sensor lead wire is burnt out.																														
Fail	Temp. Sensor Short-circuited	Temperature sensor lead wire is short-circuited.																														
<b>ESV1</b> 0.00	<b>EVT1 value</b> <ul style="list-style-type: none"> <li>Sets an EVT1 value.</li> <li>Available when <b>PH_L</b> (pH input low limit action), <b>PH_H</b> (pH input high limit action), <b>TEMPL</b> (Temperature input low limit action) or <b>TEMPH</b> (Temperature input high limit action) is selected in [EVT1 type]</li> <li>Setting range: pH input: pH 0.00 to 14.00 (*) Temperature input: 0.0 to 100.0°C (*)</li> </ul>	pH input: pH 0.00 Temperature input: 0.0°C																														

(\*) The placement of the decimal point does not follow the selection. It is fixed.

Character	Setting Item, Function, Setting Range	Factory Default
EP1□□ □□□0.00	<b>EVT1 proportional band</b>  <ul style="list-style-type: none"> <li>Sets EVT1 proportional band. ON/OFF control when set to 0.00 or 0.0.</li> <li>Available when <b>pH-L</b>□□ (pH input low limit action), <b>pH-H</b>□□ (pH input high limit action), <b>TEMPL</b>□ (Temperature input low limit action) or <b>TEMPH</b>□ (Temperature input high limit action) is selected in [EVT1 type]</li> <li>Setting range: pH input: pH 0.00 to 14.00 (*) Temperature input: 0.0 to 100.0°C (*)</li> </ul>	pH input: pH 0.00 Temperature input: 0.0°C
EIRST □□□0.00	<b>EVT1 reset</b>  <ul style="list-style-type: none"> <li>Sets the EVT1 reset value.</li> <li>Available when <b>pH-L</b>□□ (pH input low limit action), <b>pH-H</b>□□ (pH input high limit action), <b>TEMPL</b>□ (Temperature input low limit action) or <b>TEMPH</b>□ (Temperature input high limit action) is selected in [EVT1 type]</li> <li>Not available for ON/OFF control.</li> <li>Setting range: pH input: pH ±4.00 (*) Temperature input: ±10.0°C (*)</li> </ul>	pH input: pH 0.00 Temperature input: 0.0°C
E1DIF SDIF□□	<b>EVT1 hysteresis type</b>  <ul style="list-style-type: none"> <li>Selects EVT1 output hysteresis type (Medium or Reference Value). (Fig. 6.6-1)(p.30)</li> <li>Available when <b>pH-L</b>□□ (pH input low limit action), <b>pH-H</b>□□ (pH input high limit action), <b>TEMPL</b>□ (Temperature input low limit action) or <b>TEMPH</b>□ (Temperature input high limit action) is selected in [EVT1 type]</li> <li>Not available for P control.</li> <li><b>CDIF</b>□□: Medium Value Sets the same value for both ON and OFF sides in relation to EVT1 value. Only ON side needs to be set.</li> <li><b>SDIF</b>□□: Reference Value Sets individual values for ON and OFF sides in relation to EVT1 value. Both ON and OFF sides need to be set individually.</li> </ul>	Reference Value
E1DF0 □□□0.10	<b>EVT1 ON side</b>  <ul style="list-style-type: none"> <li>Sets the span of EVT1 ON side. (Fig. 6.6-1)(p.30) If <b>CDIF</b>□□ (Medium Value) is selected in [EVT1 hysteresis type], the span of ON/OFF side will be the same value.</li> <li>Available when <b>pH-L</b>□□ (pH input low limit action), <b>pH-H</b>□□ (pH input high limit action), <b>TEMPL</b>□ (Temperature input low limit action) or <b>TEMPH</b>□ (Temperature input high limit action) is selected in [EVT1 type]</li> <li>Not available for P control.</li> <li>Setting range: pH input: pH 0.00 to 4.00 (*) Temperature input: 0.0 to 10.0°C (*)</li> </ul>	pH input: pH 0.10 Temperature input: 1.0°C
E1DFU □□□0.10	<b>EVT1 OFF side</b>  <ul style="list-style-type: none"> <li>Sets the span of EVT1 OFF side. (Fig. 6.6-1)(p.30)</li> <li>Available when <b>pH-L</b>□□ (pH input low limit action), <b>pH-H</b>□□ (pH input high limit action), <b>TEMPL</b>□ (Temperature input low limit action) or <b>TEMPH</b>□ (Temperature input high limit action) is selected in [EVT1 type]</li> <li>Available when <b>SDIF</b>□□ (Reference Value) is selected in [EVT1 hysteresis type]. Not available for P control.</li> <li>Setting range: pH input: pH 0.00 to 4.00 (*) Temperature input: 0.0 to 10.0°C (*)</li> </ul>	pH input: pH 0.10 Temperature input: 1.0°C

(\*) The placement of the decimal point does not follow the selection. It is fixed.

Character	Setting Item, Function, Setting Range	Factory Default
E10NT □□□□□0	<b>EVT1 ON delay time</b> • Sets EVT1 ON delay time. The EVT1 output does not turn ON (under the conditions of turning ON) until the time set in [EVT1 ON delay time] elapses. • Available when <b>pH-L</b> (pH input low limit action), <b>pH-H</b> (pH input high limit action), <b>TEMP-L</b> (Temperature input low limit action) or <b>TEMP-H</b> (Temperature input high limit action) is selected in [EVT1 type] • Not available for P control. • Setting range: 0 to 10000 seconds	0 sec.
E10FT □□□□□0	<b>EVT1 OFF delay time</b> • Sets EVT1 OFF delay time. The EVT1 output does not turn OFF (under the conditions of turning OFF) until the time set in [EVT1 OFF delay time] elapses. • Available when <b>pH-L</b> (pH input low limit action), <b>pH-H</b> (pH input high limit action), <b>TEMP-L</b> (Temperature input low limit action) or <b>TEMP-H</b> (Temperature input high limit action) is selected in [EVT1 type] • Not available for P control. • Setting range: 0 to 10000 seconds	0 sec.
E1C □□□□30	<b>EVT1 proportional cycle</b> • Sets proportional cycle for EVT1. • Available when <b>pH-L</b> (pH input low limit action), <b>pH-H</b> (pH input high limit action), <b>TEMP-L</b> (Temperature input low limit action) or <b>TEMP-H</b> (Temperature input high limit action) is selected in [EVT1 type] • Not available for ON/OFF control. • Setting range: 1 to 300 seconds	30 sec.
E10LH □□□□100	<b>EVT1 output high limit</b> • Sets EVT1 output high limit value. • Available when <b>pH-L</b> (pH input low limit action), <b>pH-H</b> (pH input high limit action), <b>TEMP-L</b> (Temperature input low limit action) or <b>TEMP-H</b> (Temperature input high limit action) is selected in [EVT1 type] • Not available for ON/OFF control. • Setting range: EVT1 output low limit value to 100%	100%
E10LL □□□□□0	<b>EVT1 output low limit</b> • Sets EVT1 output low limit value. • Available when <b>pH-L</b> (pH input low limit action), <b>pH-H</b> (pH input high limit action), <b>TEMP-L</b> (Temperature input low limit action) or <b>TEMP-H</b> (Temperature input high limit action) is selected in [EVT1 type] • Not available for ON/OFF control. • Setting range: 0% to EVT1 output high limit value	0%
OONT1 □□□□□0	<b>Output ON time when EVT1 output ON</b> • Sets Output ON time when EVT1 output is ON. If Output ON time and OFF time are set, EVT1 output can be turned ON/OFF in a configured cycle when EVT1 output is ON. (Fig. 6.6-2)(p.30) • Available when <b>pH-L</b> (pH input low limit action), <b>pH-H</b> (pH input high limit action), <b>TEMP-L</b> (Temperature input low limit action) or <b>TEMP-H</b> (Temperature input high limit action) is selected in [EVT1 type] • Not available for P control. • Setting range: 0 to 10000 seconds	0 sec.



Character	Setting Item, Function, Setting Range	Factory Default
00FT1 □□□□□0	<b>Output OFF time when EVT1 output ON</b> • Sets Output OFF time when EVT1 output is ON. If Output ON time and OFF time are set, EVT1 output can be turned ON/OFF in a configured cycle when EVT1 output is ON. (Fig. 6.6-2)(p.30) • Available when <b>pH-L</b> □□ (pH input low limit action), <b>pH-H</b> □□ (pH input high limit action), <b>TEMPL</b> □□ (Temperature input low limit action) or <b>TEMPH</b> □□ (Temperature input high limit action) is selected in [EVT1 type] • Not available for P control. • Setting range: 0 to 10000 seconds	0 sec.
E1CS□ -----	<b>EVT1 pH input error alarm EVT□ type</b> • Selects an EVT□ type (except EVT1 type) in order to assess EVT1 pH input error alarm. • Available only when <b>EPUL</b> □□ (pH input error alarm output) is selected in [EVT1 type] • Selection item ----- : No action <b>EVT2</b> □□ : EVT2 type <b>EVT3</b> □□ : EVT3 type <b>EVT4</b> □□ : EVT4 type	No action
E1P0□ □□□□0.0	<b>EVT1 pH input error alarm span when EVT□ output ON</b> • Sets span to assess EVT1 pH input error alarm when EVT□ output is ON – which is selected in [EVT1 pH input error alarm EVT□ type]. • Available only when <b>EPUL</b> □□ (pH input error alarm output) is selected in [EVT1 type] • Setting range: pH 0.0 to 14.0 When set to 0.0, pH input error alarm is disabled.	pH 0.0
E1P0T □□□□□0	<b>EVT1 pH input error alarm time when EVT□ output ON</b> • Sets time to assess EVT1 pH input error alarm when EVT□ output is ON – which is selected in [EVT1 pH input error alarm EVT□ type]. • Available only when <b>EPUL</b> □□ (pH input error alarm output) is selected in [EVT1 type] • Setting range: 0 to 10000 seconds or minutes (Time unit follows the selection in [pH/ORP input error alarm time unit].) When set to 0, pH input error alarm is disabled.	0 sec.
E1PC□ □□□□0.0	<b>EVT1 pH input error alarm span when EVT□ output OFF</b> • Sets span to assess EVT1 pH input error alarm when EVT□ output is OFF – which is selected in [EVT1 pH input error alarm EVT□ type]. • Available only when <b>EPUL</b> □□ (pH input error alarm output) is selected in [EVT1 type] • Setting range: pH 0.0 to 14.0 When set to 0.0, pH input error alarm is disabled.	pH 0.0

Character	Setting Item, Function, Setting Range	Factory Default
E1PCT □□□□□0	<b>EVT1 pH input error alarm time when EVT□ output OFF</b> <ul style="list-style-type: none"> <li>• Sets time to assess EVT1 pH input error alarm when EVT□ output is OFF – which is selected in [EVT1 pH input error alarm EVT□ type].</li> <li>• Available only when <b>EPUL□□</b> (pH input error alarm output) is selected in [EVT1 type]</li> <li>• Setting range: 0 to 10000 seconds or minutes (Time unit follows the selection in [pH/ORP input error alarm time unit].) When set to 0, pH input error alarm is disabled.</li> </ul>	0 sec.
MVZN1 □□□50.0	<b>EVT1 cycle variable range</b> <ul style="list-style-type: none"> <li>• Sets EVT1 cycle range to be changed.</li> <li>• Available when <b>PH-L□□</b> (pH input low limit action), <b>PH-H□□</b> (pH input high limit action), <b>TEMPL□</b> (Temperature input low limit action) or <b>TEMPH□</b> (Temperature input high limit action) is selected in [EVT1 type]</li> <li>• Not available for ON/OFF control.</li> <li>• Setting range: 1.0 to 100.0%</li> </ul>	50.0%
CENT1 □□□□□0	<b>EVT1 cycle extended time</b> <ul style="list-style-type: none"> <li>• Sets time to extend EVT1 cycle.</li> <li>• Available when <b>PH-L□□</b> (pH input low limit action), <b>PH-H□□</b> (pH input high limit action), <b>TEMPL□</b> (Temperature input low limit action) or <b>TEMPH□</b> (Temperature input high limit action) is selected in [EVT1 type]</li> <li>• Not available for ON/OFF control.</li> <li>• Setting range: 0 to 300 seconds</li> </ul>	0 sec.

### 6.6.2 When Selecting ORP Meter

To enter EVT1 Group, follow the procedure below.

- ① **G\_ORP** Press the  MODE key in pH-Temperature/ORP Display Mode, or Cleansing Output Mode.
- ② **G\_E01** Press the  ▽ key as many times as necessary until the left characters appear.
- ③ **EVT1F** Press the  SET key.

The unit will enter EVT1 Group, and 'EVT1 type' will appear.

Character	Setting Item, Function, Setting Range	Factory Default
EVT1F -----	<b>EVT1 type</b> <ul style="list-style-type: none"> <li>• Selects an EVT1 output (Contact output 1) type. (Fig. 6.6-1)(p.30)</li> <li><b>Note: If EVT1 type is changed, EVT1 value will default to 0.</b></li> <li>• ----- : No action</li> <li><b>ORP-L□</b> : ORP input low limit action</li> <li><b>ORP-H□</b> : ORP input high limit action</li> <li><b>CLEG□□</b> : Cleansing output</li> <li><b>EOUL□□</b> : ORP input error alarm output</li> </ul>	No action
ESV1□ □□□□□0	<b>EVT1 value</b> <ul style="list-style-type: none"> <li>• Selects an EVT1 value.</li> <li>• Available when <b>ORP-L□</b> (ORP input low limit action) or <b>ORP-H□</b> (ORP input high limit action) is selected in [EVT1 type].</li> <li>• Setting range: Input low limit to Input high limit</li> </ul>	0 mV
EP1□□ □□□□□0	<b>EVT1 proportional band</b> <ul style="list-style-type: none"> <li>• Sets EVT1 proportional band.</li> <li>ON/OFF control when set to 0.</li> <li>• Available when <b>ORP-L□</b> (ORP input low limit action) or <b>ORP-H□</b> (ORP input high limit action) is selected in [EVT1 type].</li> <li>• Setting range: 0 to Input span</li> </ul>	0 mV

Character	Setting Item, Function, Setting Range	Factory Default
E1RST □□□□0	<b>EVT1 reset</b> <ul style="list-style-type: none"> <li>• Sets the EVT1 reset value.</li> <li>• Available when <b>ORP-L</b> (ORP input low limit action) or <b>ORP-H</b> (ORP input high limit action) is selected in [EVT1 type].</li> <li>• Not available for ON/OFF control.</li> <li>• Setting range: <math>\pm 200</math> mV</li> </ul>	0 mV
E1DIF SDIF□□	<b>EVT1 hysteresis type</b> <ul style="list-style-type: none"> <li>• Selects EVT1 output hysteresis type (Medium or Reference Value). (Fig. 6.6-1)(p.30)</li> <li>• Available when <b>ORP-L</b> (ORP input low limit action) or <b>ORP-H</b> (ORP input high limit action) is selected in [EVT1 type].</li> <li>• Not available for P control.</li> <li>• <b>CDIF</b>□□: Medium Value  Sets the same value for both ON and OFF sides in relation to EVT1 value.  Only ON side needs to be set.</li> <li>• <b>SDIF</b>□□: Reference Value  Sets individual values for ON and OFF sides in relation to EVT1 value.  Both ON and OFF sides need to be set individually.</li> </ul>	Reference Value
E1DF0 □□□□10	<b>EVT1 ON side</b> <ul style="list-style-type: none"> <li>• Sets the span of EVT1 ON side. (Fig. 6.6-1)(p.30)</li> <li>• If <b>CDIF</b>□□ (Medium Value) is selected in [EVT1 hysteresis type], the span of ON/OFF side will be the same value.</li> <li>• Available when <b>ORP-L</b> (ORP input low limit action) or <b>ORP-H</b> (ORP input high limit action) is selected in [EVT1 type].</li> <li>• Not available for P control.</li> <li>• Setting range: 0 to 200 mV</li> </ul>	10 mV
E1DFU □□□□10	<b>EVT1 OFF side</b> <ul style="list-style-type: none"> <li>• Sets the span of EVT1 OFF side. (Fig. 6.6-1)(p.30)</li> <li>• Available when <b>ORP-L</b> (ORP input low limit action) or <b>ORP-H</b> (ORP input high limit action) is selected in [EVT1 type].</li> <li>• Available when <b>SDIF</b>□□ (Reference Value) is selected in [EVT1 hysteresis type].</li> <li>• Not available for P control.</li> <li>• Setting range: 0 to 200 mV</li> </ul>	10 mV
E10NT □□□□0	<b>EVT1 ON delay time</b> <ul style="list-style-type: none"> <li>• Sets EVT1 ON delay time.</li> <li>• The EVT1 output does not turn ON (under the conditions of turning ON) until the time set in [EVT1 ON delay time] elapses.</li> <li>• Available when <b>ORP-L</b> (ORP input low limit action) or <b>ORP-H</b> (ORP input high limit action) is selected in [EVT1 type].</li> <li>• Not available for P control.</li> <li>• Setting range: 0 to 10000 seconds</li> </ul>	0 sec.
E10FT □□□□0	<b>EVT1 OFF delay time</b> <ul style="list-style-type: none"> <li>• Sets EVT1 OFF delay time.</li> <li>• The EVT1 output does not turn OFF (under the conditions of turning OFF) until the time set in [EVT1 OFF delay time] elapses.</li> <li>• Available when <b>ORP-L</b> (ORP input low limit action) or <b>ORP-H</b> (ORP input high limit action) is selected in [EVT1 type].</li> <li>• Not available for P control.</li> <li>• Setting range: 0 to 10000 seconds</li> </ul>	0 sec.

Character	Setting Item, Function, Setting Range	Factory Default
E1C□□ □□□□30	<b>EVT1 proportional cycle</b> <ul style="list-style-type: none"> <li>• Sets proportional cycle for EVT1.</li> <li>• Available when <b>ORP-L</b>□ (ORP input low limit action) or <b>ORP-H</b>□ (ORP input high limit action) is selected in [EVT1 type].</li> <li>• Not available for ON/OFF control.</li> <li>• Setting range: 1 to 300 seconds</li> </ul>	30 sec.
E10LH □□□100	<b>EVT1 output high limit</b> <ul style="list-style-type: none"> <li>• Sets EVT1 output high limit value.</li> <li>• Available when <b>ORP-L</b>□ (ORP input low limit action) or <b>ORP-H</b>□ (ORP input high limit action) is selected in [EVT1 type].</li> <li>• Not available for ON/OFF control.</li> <li>• Setting range: EVT1 output low limit value to 100%</li> </ul>	100%
E10LL □□□□0	<b>EVT1 output low limit</b> <ul style="list-style-type: none"> <li>• Sets EVT1 output low limit value.</li> <li>• Available when <b>ORP-L</b>□ (ORP input low limit action) or <b>ORP-H</b>□ (ORP input high limit action) is selected in [EVT1 type].</li> <li>• Not available for ON/OFF control.</li> <li>• Setting range: 0% to EVT1 output high limit value</li> </ul>	0%
OONT1 □□□□0	<b>Output ON time when EVT1 output ON</b> <ul style="list-style-type: none"> <li>• Sets Output ON time when EVT1 output is ON.</li> <li>• If ON time and OFF time are set, EVT1 output can be turned ON/OFF in a configured cycle when EVT1 output is ON. (Fig. 6.6-2)(p.30)</li> <li>• Available when <b>ORP-L</b>□ (ORP input low limit action) or <b>ORP-H</b>□ (ORP input high limit action) is selected in [EVT1 type].</li> <li>• Not available for P control.</li> <li>• Setting range: 0 to 10000 seconds</li> </ul>	0 sec.
OOF1 □□□□0	<b>Output OFF time when EVT1 output ON</b> <ul style="list-style-type: none"> <li>• Sets Output OFF time when EVT1 output is ON.</li> <li>• If ON time and OFF time are set, EVT1 output can be turned ON/OFF in a configured cycle when EVT1 output is ON. (Fig. 6.6-2)(p.30)</li> <li>• Available when <b>ORP-L</b>□ (ORP input low limit action) or <b>ORP-H</b>□ (ORP input high limit action) is selected in [EVT1 type].</li> <li>• Not available for P control.</li> <li>• Setting range: 0 to 10000 seconds</li> </ul>	0 sec.
E1CS□ -----	<b>EVT1 ORP input error alarm EVT□ type</b> <ul style="list-style-type: none"> <li>• Selects an EVT□ type (except EVT1 type) in order to assess EVT1 ORP input error alarm.</li> <li>• Available only when <b>EOUL</b>□□ (ORP input error alarm output) is selected in [EVT1 type]</li> <li>• Selection item  ----- : No action  <b>EVT2</b>□□ : EVT2 type  <b>EVT3</b>□□ : EVT3 type  <b>EVT4</b>□□ : EVT4 type </li> </ul>	No action
E100□ □□□□0	<b>EVT1 ORP input error alarm span when EVT□ output ON</b> <ul style="list-style-type: none"> <li>• Sets span to assess EVT1 ORP input error alarm when EVT□ output is ON – which is selected in [EVT1 ORP input error alarm EVT□ type].</li> <li>• Available only when <b>EOUL</b>□□ (ORP input error alarm output) is selected in [EVT1 type]</li> <li>• Setting range: 0 to 2000 mV When set to 0, ORP input error alarm is disabled.</li> </ul>	0 mV

Character	Setting Item, Function, Setting Range	Factory Default
<b>E100T</b> □□□□□ 0	<b>EVT1 ORP input error alarm time when EVT□ output ON</b> <ul style="list-style-type: none"> <li>• Sets time to assess EVT1 ORP input error alarm when EVT□ output is ON – which is selected in [EVT1 ORP input error alarm EVT□ type].</li> <li>• Available only when <b>E0UL</b>□□ (ORP input error alarm output) is selected in [EVT1 type]</li> <li>• Setting range: 0 to 10000 seconds or minutes (Time unit follows the selection in [pH/ORP input error alarm time unit].) When set to 0, ORP input error alarm is disabled.</li> </ul>	0 sec.
<b>E10C</b> □ □□□□□ 0	<b>EVT1 ORP input error alarm span when EVT□ output OFF</b> <ul style="list-style-type: none"> <li>• Sets span to assess EVT1 ORP input error alarm when EVT□ output is OFF – which is selected in [EVT1 ORP input error alarm EVT□ type].</li> <li>• Available only when <b>E0UL</b>□□ (ORP input error alarm output) is selected in [EVT1 type]</li> <li>• Setting range: 0 to 2000 mV When set to 0, ORP input error alarm is disabled.</li> </ul>	0 mV
<b>E10CT</b> □□□□□ 0	<b>EVT1 ORP input error alarm time when EVT□ output OFF</b> <ul style="list-style-type: none"> <li>• Sets time to assess EVT1 ORP input error alarm when EVT□ output is OFF – which is selected in [EVT1 ORP input error alarm EVT□ type].</li> <li>• Available only when <b>E0UL</b>□□ (ORP input error alarm output) is selected in [EVT1 type]</li> <li>• Setting range: 0 to 10000 seconds or minutes (Time unit follows the selection in [pH/ORP input error alarm time unit].) When set to 0, ORP input error alarm is disabled.</li> </ul>	0 sec.
<b>MVZN1</b> □□□ 50.0	<b>EVT1 cycle variable range</b> <ul style="list-style-type: none"> <li>• Sets EVT1 cycle range to be changed.</li> <li>• Available when <b>ORP-L</b>□ (ORP input low limit action) or <b>ORP-H</b>□ (ORP input high limit action) is selected in [EVT1 type].</li> <li>• Not available for ON/OFF control.</li> <li>• Setting range: 1.0 to 100.0%</li> </ul>	50.0%
<b>CENT1</b> □□□□□ 0	<b>EVT1 cycle extended time</b> <ul style="list-style-type: none"> <li>• Sets time to extend EVT1 cycle.</li> <li>• Available when <b>ORP-L</b>□ (ORP input low limit action) or <b>ORP-H</b>□ (ORP input high limit action) is selected in [EVT1 type].</li> <li>• Not available for ON/OFF control.</li> <li>• Setting range: 0 to 300 seconds</li> </ul>	0 sec.

### EVT1 Action

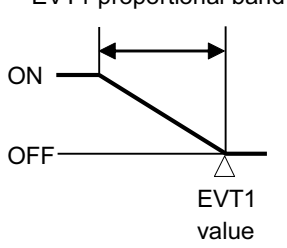
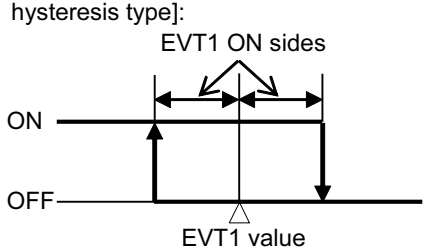
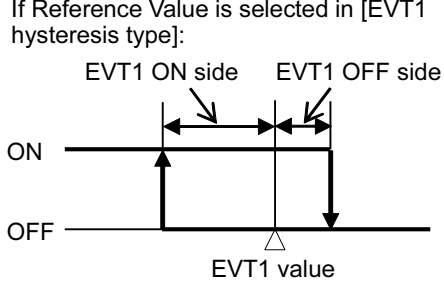
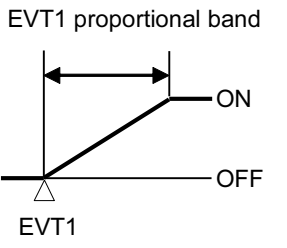
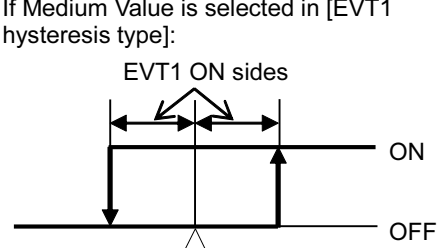
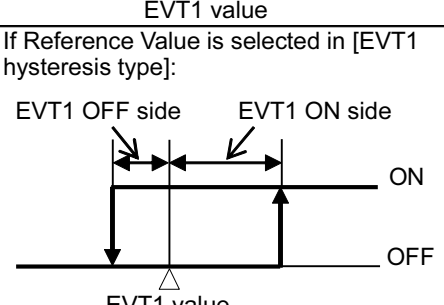
EVT1 Type	P Control Action	ON/OFF Control Action
<p>pH input low limit action, Temperature input low limit action, ORP input low limit action</p>	<p>EVT1 proportional band</p> 	<p>If Medium Value is selected in [EVT1 hysteresis type]:</p>  <p>If Reference Value is selected in [EVT1 hysteresis type]:</p> 
<p>pH input high limit action, Temperature input high limit action, ORP input high limit action</p>	<p>EVT1 proportional band</p> 	<p>If Medium Value is selected in [EVT1 hysteresis type]:</p>  <p>If Reference Value is selected in [EVT1 hysteresis type]:</p> 

(Fig. 6.6-1)

### Timing chart of EVT1 output ON time and OFF time while in EVT1 output ON

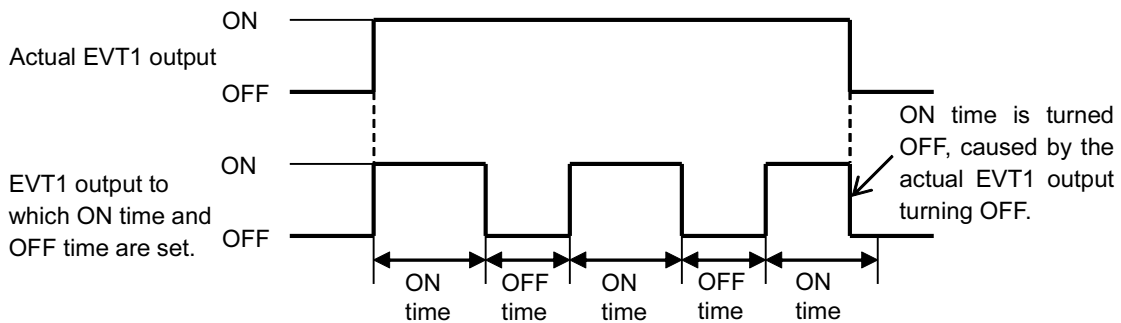

(Fig. 6.6-2)



Character	Setting Item, Function, Setting Range	Factory Default
EP2 0.00	<b>EVT2 proportional band</b>  <ul style="list-style-type: none"> <li>Sets EVT2 proportional band. ON/OFF control when set to 0.00 or 0.0.</li> <li>Available when <b>PH-L</b> (pH input low limit action), <b>PH-H</b> (pH input high limit action), <b>TEMPL</b> (Temperature input low limit action) or <b>TEMPH</b> (Temperature input high limit action) is selected in [EVT2 type]</li> <li>Setting range: pH input: pH 0.00 to 14.00 (*) Temperature input: 0.0 to 100.0°C (*)</li> </ul>	pH input: pH 0.00 Temperature input: 0.0°C
E2RST 0.00	<b>EVT2 reset</b>  <ul style="list-style-type: none"> <li>Sets the EVT2 reset value.</li> <li>Available when <b>PH-L</b> (pH input low limit action), <b>PH-H</b> (pH input high limit action), <b>TEMPL</b> (Temperature input low limit action) or <b>TEMPH</b> (Temperature input high limit action) is selected in [EVT2 type]</li> <li>Not available for ON/OFF control.</li> <li>Setting range: pH input: pH ±4.00 (*) Temperature input: ±10.0°C (*)</li> </ul>	pH input: pH 0.00 Temperature input: 0.0°C
E2DIF SDIF	<b>EVT2 hysteresis type</b>  <ul style="list-style-type: none"> <li>Selects EVT2 output hysteresis type (Medium or Reference Value). (Fig. 6.7-1)(p.39)</li> <li>Available when <b>PH-L</b> (pH input low limit action), <b>PH-H</b> (pH input high limit action), <b>TEMPL</b> (Temperature input low limit action) or <b>TEMPH</b> (Temperature input high limit action) is selected in [EVT2 type]</li> <li>Not available for P control.</li> <li><b>CDIF</b>: Medium Value Sets the same value for both ON and OFF sides in relation to EVT2 value. Only ON side needs to be set.</li> <li><b>SDIF</b>: Reference Value Sets individual values for ON and OFF sides in relation to EVT2 value. Both ON and OFF sides need to be set individually.</li> </ul>	Reference Value
E2DF0 0.10	<b>EVT2 ON side</b>  <ul style="list-style-type: none"> <li>Sets the span of EVT2 ON side. (Fig. 6.7-1)(p.39) If <b>CDIF</b> (Medium Value) is selected in [EVT2 hysteresis type], the span of ON/OFF side will be the same value.</li> <li>Available when <b>PH-L</b> (pH input low limit action), <b>PH-H</b> (pH input high limit action), <b>TEMPL</b> (Temperature input low limit action) or <b>TEMPH</b> (Temperature input high limit action) is selected in [EVT2 type]</li> <li>Not available for P control.</li> <li>Setting range: pH input: pH 0.00 to 4.00 (*) Temperature input: 0.0 to 10.0°C (*)</li> </ul>	pH input: pH 0.10 Temperature input: 1.0°C
E2DFU 0.10	<b>EVT2 OFF side</b>  <ul style="list-style-type: none"> <li>Sets the span of EVT2 OFF side. (Fig. 6.7-1)(p.39)</li> <li>Available when <b>PH-L</b> (pH input low limit action), <b>PH-H</b> (pH input high limit action), <b>TEMPL</b> (Temperature input low limit action) or <b>TEMPH</b> (Temperature input high limit action) is selected in [EVT2 type]</li> <li>Available when <b>SDIF</b> (Reference Value) is selected in [EVT2 hysteresis type]. Not available for P control.</li> <li>Setting range: pH input: pH 0.00 to 4.00 (*) Temperature input: 0.0 to 10.0°C (*)</li> </ul>	pH input: pH 0.10 Temperature input: 1.0°C

(\*) The placement of the decimal point does not follow the selection. It is fixed.



Character	Setting Item, Function, Setting Range	Factory Default
E20NT □□□□□0	<b>EVT2 ON delay time</b> • Sets EVT2 ON delay time. The EVT2 output does not turn ON (under the conditions of turning ON) until the time set in [EVT2 ON delay time] elapses. • Available when <b>pH-L</b> (pH input low limit action), <b>pH-H</b> (pH input high limit action), <b>TEMP-L</b> (Temperature input low limit action) or <b>TEMP-H</b> (Temperature input high limit action) is selected in [EVT2 type] • Not available for P control. • Setting range: 0 to 10000 seconds	0 sec.
E20FT □□□□□0	<b>EVT2 OFF delay time</b> • Sets EVT2 OFF delay time. The EVT2 output does not turn OFF (under the conditions of turning OFF) until the time set in [EVT2 OFF delay time] elapses. • Available when <b>pH-L</b> (pH input low limit action), <b>pH-H</b> (pH input high limit action), <b>TEMP-L</b> (Temperature input low limit action) or <b>TEMP-H</b> (Temperature input high limit action) is selected in [EVT2 type] • Not available for P control. • Setting range: 0 to 10000 seconds	0 sec.
E20C □□□□30	<b>EVT2 proportional cycle</b> • Sets proportional cycle for EVT2. • Available when <b>pH-L</b> (pH input low limit action), <b>pH-H</b> (pH input high limit action), <b>TEMP-L</b> (Temperature input low limit action) or <b>TEMP-H</b> (Temperature input high limit action) is selected in [EVT2 type] • Not available for ON/OFF control. • Setting range: 1 to 300 seconds	30 sec.
E20LH □□□100	<b>EVT2 output high limit</b> • Sets EVT2 output high limit value. • Available when <b>pH-L</b> (pH input low limit action), <b>pH-H</b> (pH input high limit action), <b>TEMP-L</b> (Temperature input low limit action) or <b>TEMP-H</b> (Temperature input high limit action) is selected in [EVT2 type] • Not available for ON/OFF control. • Setting range: EVT2 output low limit value to 100%	100%
E20LL □□□□□0	<b>EVT2 output low limit</b> • Sets EVT2 output low limit value. • Available when <b>pH-L</b> (pH input low limit action), <b>pH-H</b> (pH input high limit action), <b>TEMP-L</b> (Temperature input low limit action) or <b>TEMP-H</b> (Temperature input high limit action) is selected in [EVT2 type] • Not available for ON/OFF control. • Setting range: 0% to EVT2 output high limit value	0%
O0NT2 □□□□□0	<b>Output ON time when EVT2 output ON</b> • Sets Output ON time when EVT2 output is ON. If Output ON time and OFF time are set, EVT2 output can be turned ON/OFF in a configured cycle when EVT2 output is ON. (Fig. 6.7-2)(p.39) • Available when <b>pH-L</b> (pH input low limit action), <b>pH-H</b> (pH input high limit action), <b>TEMP-L</b> (Temperature input low limit action) or <b>TEMP-H</b> (Temperature input high limit action) is selected in [EVT2 type] • Not available for P control. • Setting range: 0 to 10000 seconds	0 sec.

Character	Setting Item, Function, Setting Range	Factory Default
00FT2 □□□□0	<b>Output OFF time when EVT2 output ON</b> <ul style="list-style-type: none"> <li>Sets Output OFF time when EVT2 output is ON.</li> <li>If Output ON time and OFF time are set, EVT2 output can be turned ON/OFF in a configured cycle when EVT2 output is ON. (Fig. 6.7-2)(p.39)</li> <li>Available when <b>pH-L</b>□□ (pH input low limit action), <b>pH-H</b>□□ (pH input high limit action), <b>TEMP-L</b>□□ (Temperature input low limit action) or <b>TEMP-H</b>□□ (Temperature input high limit action) is selected in [EVT2 type]</li> <li>Not available for P control.</li> <li>Setting range: 0 to 10000 seconds</li> </ul>	0 sec.
E2CS□ -----	<b>EVT2 pH input error alarm EVT□ type</b> <ul style="list-style-type: none"> <li>Selects an EVT□ type (except EVT2 type) in order to assess EVT2 pH input error alarm.</li> <li>Available only when <b>EPUL</b>□□ (pH input error alarm output) is selected in [EVT2 type]</li> <li>Selection item  <b>EVT1</b>□□ : EVT1 type            ----- : No action  <b>EVT3</b>□□ : EVT3 type  <b>EVT4</b>□□ : EVT4 type</li> </ul>	No action
E2P0□ □□□□0.0	<b>EVT2 pH input error alarm span when EVT□ output ON</b> <ul style="list-style-type: none"> <li>Sets span to assess EVT2 pH input error alarm when EVT□ output is ON – which is selected in [EVT2 pH input error alarm EVT□ type].</li> <li>Available only when <b>EPUL</b>□□ (pH input error alarm output) is selected in [EVT2 type]</li> <li>Setting range: pH 0.0 to 14.0 When set to 0.0, pH input error alarm is disabled.</li> </ul>	pH 0.0
E2P0T □□□□0	<b>EVT2 pH input error alarm time when EVT□ output ON</b> <ul style="list-style-type: none"> <li>Sets time to assess EVT2 pH input error alarm when EVT□ output is ON – which is selected in [EVT2 pH input error alarm EVT□ type].</li> <li>Available only when <b>EPUL</b>□□ (pH input error alarm output) is selected in [EVT2 type]</li> <li>Setting range: 0 to 10000 seconds or minutes (Time unit follows the selection in [pH/ORP input error alarm time unit].) When set to 0, pH input error alarm is disabled.</li> </ul>	0 sec.
E2PC□ □□□□0.0	<b>EVT2 pH input error alarm span when EVT□ output OFF</b> <ul style="list-style-type: none"> <li>Sets span to assess EVT2 pH input error alarm when EVT□ output is OFF – which is selected in [EVT2 pH input error alarm EVT□ type].</li> <li>Available only when <b>EPUL</b>□□ (pH input error alarm output) is selected in [EVT2 type]</li> <li>Setting range: pH 0.0 to 14.0 When set to 0.0, pH input error alarm is disabled.</li> </ul>	pH 0.0

Character	Setting Item, Function, Setting Range	Factory Default
<b>E2PCT</b> □□□□□ <b>0</b>	<b>EVT2 pH input error alarm time when EVT□ output OFF</b> <ul style="list-style-type: none"> <li>• Sets time to assess EVT2 pH input error alarm when EVT□ output is OFF – which is selected in [EVT2 pH input error alarm EVT□ type].</li> <li>• Available only when <b>EPUL</b>□□ (pH input error alarm output) is selected in [EVT2 type]</li> <li>• Setting range: 0 to 10000 seconds or minutes (Time unit follows the selection in [pH/ORP input error alarm time unit].) When set to 0, pH input error alarm is disabled.</li> </ul>	0 sec.
<b>MVZN2</b> □□□ <b>50.0</b>	<b>EVT2 cycle variable range</b> <ul style="list-style-type: none"> <li>• Sets EVT2 cycle range to be changed.</li> <li>• Available when <b>pH-L</b>□□ (pH input low limit action), <b>pH-H</b>□□ (pH input high limit action), <b>TEMPL</b>□ (Temperature input low limit action) or <b>TEMPH</b>□ (Temperature input high limit action) is selected in [EVT2 type]</li> <li>• Not available for ON/OFF control.</li> <li>• Setting range: 1.0 to 100.0%</li> </ul>	50.0%
<b>CENT2</b> □□□□□ <b>0</b>	<b>EVT2 cycle extended time</b> <ul style="list-style-type: none"> <li>• Sets time to extend EVT2 cycle.</li> <li>• Available when <b>pH-L</b>□□ (pH input low limit action), <b>pH-H</b>□□ (pH input high limit action), <b>TEMPL</b>□ (Temperature input low limit action) or <b>TEMPH</b>□ (Temperature input high limit action) is selected in [EVT2 type]</li> <li>• Not available for ON/OFF control.</li> <li>• Setting range: 0 to 300 seconds</li> </ul>	0 sec.

### 6.7.2 When Selecting ORP Meter

To enter EVT2 Group, follow the procedure below.

- ① **G\_ORP** Press the  key in pH-Temperature/ORP Display Mode, or Cleansing Output Mode.
- ② **G\_E02** Press the  key as many times as necessary until the left characters appear.
- ③ **EVT2F** Press the  key.

The unit will enter EVT2 Group, and 'EVT2 type' will appear.

Character	Setting Item, Function, Setting Range	Factory Default
<b>EVT2F</b> -----	<b>EVT2 type</b> <ul style="list-style-type: none"> <li>• Selects an EVT2 output (Contact output 2) type. (Fig. 6.7-1)(p.39)</li> <li><b>Note: If EVT2 type is changed, EVT2 value will default to 0.</b></li> <li>• ----- : No action</li> <li>• <b>ORP-L</b>□ : ORP input low limit action</li> <li>• <b>ORP-H</b>□ : ORP input high limit action</li> <li>• <b>CLEG</b>□□ : Cleansing output</li> <li>• <b>EOUL</b>□□ : ORP input error alarm output</li> </ul>	No action
<b>ESV2</b> □ □□□□□ <b>0</b>	<b>EVT2 value</b> <ul style="list-style-type: none"> <li>• Selects an EVT2 value.</li> <li>• Available when <b>ORP-L</b>□ (ORP input low limit action) or <b>ORP-H</b>□ (ORP input high limit action) is selected in [EVT2 type].</li> <li>• Setting range: Input low limit to Input high limit</li> </ul>	0 mV
<b>EP2</b> □□ □□□□□ <b>0</b>	<b>EVT2 proportional band</b> <ul style="list-style-type: none"> <li>• Sets EVT2 proportional band.</li> <li>• ON/OFF control when set to 0.</li> <li>• Available when <b>ORP-L</b>□ (ORP input low limit action) or <b>ORP-H</b>□ (ORP input high limit action) is selected in [EVT2 type].</li> <li>• Setting range: 0 to Input span</li> </ul>	0 mV

Character	Setting Item, Function, Setting Range	Factory Default
E2RST □□□□0	<b>EVT2 reset</b> <ul style="list-style-type: none"> <li>• Sets the EVT2 reset value.</li> <li>• Available when <b>ORP-L</b> (ORP input low limit action) or <b>ORP-H</b> (ORP input high limit action) is selected in [EVT2 type].</li> <li>• Not available for ON/OFF control.</li> <li>• Setting range: <math>\pm 200</math> mV</li> </ul>	0 mV
E2DIF SDIF□□	<b>EVT2 hysteresis type</b> <ul style="list-style-type: none"> <li>• Selects EVT2 output hysteresis type (Medium or Reference Value). (Fig. 6.7-1)(p.39)</li> <li>• Available when <b>ORP-L</b> (ORP input low limit action) or <b>ORP-H</b> (ORP input high limit action) is selected in [EVT2 type].</li> <li>• Not available for P control.</li> <li>• <b>CDIF</b>□□: Medium Value Sets the same value for both ON and OFF sides in relation to EVT2 value. Only ON side needs to be set.</li> <li>• <b>SDIF</b>□□: Reference Value Sets individual values for ON and OFF sides in relation to EVT2 value. Both ON and OFF sides need to be set individually.</li> </ul>	Reference Value
E2DF0 □□□□10	<b>EVT2 ON side</b> <ul style="list-style-type: none"> <li>• Sets the span of EVT2 ON side. (Fig. 6.7-1)(p.39)</li> <li>• If <b>CDIF</b>□□ (Medium Value) is selected in [EVT2 hysteresis type], the span of ON/OFF side will be the same value.</li> <li>• Available when <b>ORP-L</b> (ORP input low limit action) or <b>ORP-H</b> (ORP input high limit action) is selected in [EVT2 type].</li> <li>• Not available for P control.</li> <li>• Setting range: 0 to 200 mV</li> </ul>	10 mV
E2DFU □□□□10	<b>EVT2 OFF side</b> <ul style="list-style-type: none"> <li>• Sets the span of EVT2 OFF side. (Fig. 6.7-1)(p.39)</li> <li>• Available when <b>ORP-L</b> (ORP input low limit action) or <b>ORP-H</b> (ORP input high limit action) is selected in [EVT2 type].</li> <li>• Available when <b>SDIF</b>□□ (Reference Value) is selected in [EVT2 hysteresis type].</li> <li>• Not available for P control.</li> <li>• Setting range: 0 to 200 mV</li> </ul>	10 mV
E20NT □□□□0	<b>EVT2 ON delay time</b> <ul style="list-style-type: none"> <li>• Sets EVT2 ON delay time.</li> <li>• The EVT2 output does not turn ON (under the conditions of turning ON) until the time set in [EVT2 ON delay time] elapses.</li> <li>• Available when <b>ORP-L</b> (ORP input low limit action) or <b>ORP-H</b> (ORP input high limit action) is selected in [EVT2 type].</li> <li>• Not available for P control.</li> <li>• Setting range: 0 to 10000 seconds</li> </ul>	0 sec.
E20FT □□□□0	<b>EVT2 OFF delay time</b> <ul style="list-style-type: none"> <li>• Sets EVT2 OFF delay time.</li> <li>• The EVT2 output does not turn OFF (under the conditions of turning OFF) until the time set in [EVT2 OFF delay time] elapses.</li> <li>• Available when <b>ORP-L</b> (ORP input low limit action) or <b>ORP-H</b> (ORP input high limit action) is selected in [EVT2 type].</li> <li>• Not available for P control.</li> <li>• Setting range: 0 to 10000 seconds</li> </ul>	0 sec.

Character	Setting Item, Function, Setting Range	Factory Default
E2C <input type="text"/> <input type="text"/> <input type="text"/> <input type="text"/> <input type="text"/> <input type="text"/> <b>30</b>	<b>EVT2 proportional cycle</b> <ul style="list-style-type: none"> <li>• Sets proportional cycle for EVT2.</li> <li>• Available when <b>ORP-L</b> (ORP input low limit action) or <b>ORP-H</b> (ORP input high limit action) is selected in [EVT2 type].</li> <li>• Not available for ON/OFF control.</li> <li>• Setting range: 1 to 300 seconds</li> </ul>	30 sec.
E20LH <input type="text"/> <input type="text"/> <input type="text"/> <input type="text"/> <input type="text"/> <b>100</b>	<b>EVT2 output high limit</b> <ul style="list-style-type: none"> <li>• Sets EVT2 output high limit value.</li> <li>• Available when <b>ORP-L</b> (ORP input low limit action) or <b>ORP-H</b> (ORP input high limit action) is selected in [EVT2 type].</li> <li>• Not available for ON/OFF control.</li> <li>• Setting range: EVT2 output low limit value to 100%</li> </ul>	100%
E20LL <input type="text"/> <input type="text"/> <input type="text"/> <input type="text"/> <input type="text"/> <input type="text"/> <b>0</b>	<b>EVT2 output low limit</b> <ul style="list-style-type: none"> <li>• Sets EVT2 output low limit value.</li> <li>• Available when <b>ORP-L</b> (ORP input low limit action) or <b>ORP-H</b> (ORP input high limit action) is selected in [EVT2 type].</li> <li>• Not available for ON/OFF control.</li> <li>• Setting range: 0% to EVT2 output high limit value</li> </ul>	0%
00NT2 <input type="text"/> <input type="text"/> <input type="text"/> <input type="text"/> <input type="text"/> <input type="text"/> <b>0</b>	<b>Output ON time when EVT2 output ON</b> <ul style="list-style-type: none"> <li>• Sets Output ON time when EVT2 output is ON.</li> <li>If ON time and OFF time are set, EVT2 output can be turned ON/OFF in a configured cycle when EVT2 output is ON. (Fig. 6.7-2)(p.39)</li> <li>• Available when <b>ORP-L</b> (ORP input low limit action) or <b>ORP-H</b> (ORP input high limit action) is selected in [EVT2 type].</li> <li>• Not available for P control.</li> <li>• Setting range: 0 to 10000 seconds</li> </ul>	0 sec.
00FT2 <input type="text"/> <input type="text"/> <input type="text"/> <input type="text"/> <input type="text"/> <input type="text"/> <b>0</b>	<b>Output OFF time when EVT2 output ON</b> <ul style="list-style-type: none"> <li>• Sets Output OFF time when EVT2 output is ON.</li> <li>If ON time and OFF time are set, EVT2 output can be turned ON/OFF in a configured cycle when EVT2 output is ON. (Fig. 6.7-2)(p.39)</li> <li>• Available when <b>ORP-L</b> (ORP input low limit action) or <b>ORP-H</b> (ORP input high limit action) is selected in [EVT2 type].</li> <li>• Not available for P control.</li> <li>• Setting range: 0 to 10000 seconds</li> </ul>	0 sec.
E2CS <input type="text"/> -----	<b>EVT2 ORP input error alarm EVT <input type="text"/> type</b> <ul style="list-style-type: none"> <li>• Selects an EVT <input type="text"/> type (except EVT2 type) in order to assess EVT2 ORP input error alarm.</li> <li>• Available only when <b>EOUL</b> (ORP input error alarm output) is selected in [EVT2 type]</li> <li>• Selection item  <b>EVT1</b> <input type="text"/> : EVT1 type  ----- : No action  <b>EVT3</b> <input type="text"/> : EVT3 type  <b>EVT4</b> <input type="text"/> : EVT4 type </li> </ul>	No action
E200 <input type="text"/> <input type="text"/> <input type="text"/> <input type="text"/> <input type="text"/> <input type="text"/> <b>0</b>	<b>EVT2 ORP input error alarm span when EVT <input type="text"/> output ON</b> <ul style="list-style-type: none"> <li>• Sets span to assess EVT2 ORP input error alarm when EVT <input type="text"/> output is ON – which is selected in [EVT2 ORP input error alarm EVT <input type="text"/> type].</li> <li>• Available only when <b>EOUL</b> (ORP input error alarm output) is selected in [EVT2 type]</li> <li>• Setting range: 0 to 2000 mV When set to 0, ORP input error alarm is disabled.</li> </ul>	0 mV

Character	Setting Item, Function, Setting Range	Factory Default
E200T □□□□□ 0	<b>EVT2 ORP input error alarm time when EVT□ output ON</b> <ul style="list-style-type: none"> <li>• Sets time to assess EVT2 ORP input error alarm when EVT□ output is ON – which is selected in [EVT2 ORP input error alarm EVT□ type].</li> <li>• Available only when <b>E0UL</b>□□ (ORP input error alarm output) is selected in [EVT2 type]</li> <li>• Setting range: 0 to 10000 seconds or minutes (Time unit follows the selection in [pH/ORP input error alarm time unit].) When set to 0, ORP input error alarm is disabled.</li> </ul>	0 sec.
E200C□ □□□□□ 0	<b>EVT2 ORP input error alarm span when EVT□ output OFF</b> <ul style="list-style-type: none"> <li>• Sets span to assess EVT2 ORP input error alarm when EVT□ output is OFF – which is selected in [EVT2 ORP input error alarm EVT□ type].</li> <li>• Available only when <b>E0UL</b>□□ (ORP input error alarm output) is selected in [EVT2 type]</li> <li>• Setting range: 0 to 2000 mV When set to 0, ORP input error alarm is disabled.</li> </ul>	0 mV
E200T □□□□□ 0	<b>EVT2 ORP input error alarm time when EVT□ output OFF</b> <ul style="list-style-type: none"> <li>• Sets time to assess EVT2 ORP input error alarm when EVT□ output is OFF – which is selected in [EVT2 ORP input error alarm EVT□ type].</li> <li>• Available only when <b>E0UL</b>□□ (ORP input error alarm output) is selected in [EVT2 type]</li> <li>• Setting range: 0 to 10000 seconds or minutes (Time unit follows the selection in [pH/ORP input error alarm time unit].) When set to 0, ORP input error alarm is disabled.</li> </ul>	0 sec.
MVZN2 □□ 50.0	<b>EVT2 cycle variable range</b> <ul style="list-style-type: none"> <li>• Sets EVT2 cycle range to be changed.</li> <li>• Available when <b>ORP-L</b>□ (ORP input low limit action) or <b>ORP-H</b>□ (ORP input high limit action) is selected in [EVT2 type].</li> <li>• Not available for ON/OFF control.</li> <li>• Setting range: 1.0 to 100.0%</li> </ul>	50.0%
CENT2 □□□□□ 0	<b>EVT2 cycle extended time</b> <ul style="list-style-type: none"> <li>• Sets time to extend EVT2 cycle.</li> <li>• Available when <b>ORP-L</b>□ (ORP input low limit action) or <b>ORP-H</b>□ (ORP input high limit action) is selected in [EVT2 type].</li> <li>• Not available for ON/OFF control.</li> <li>• Setting range: 0 to 300 seconds</li> </ul>	0 sec.

**EVT2 Action**

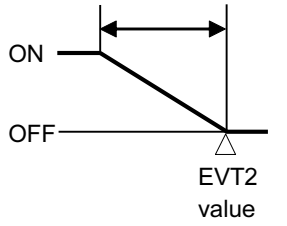
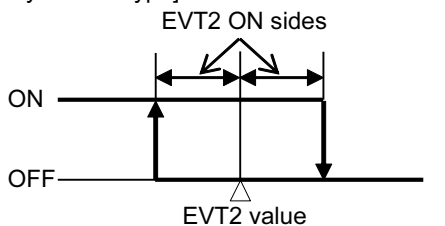
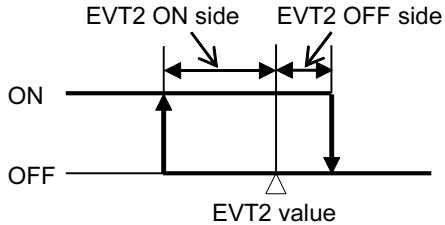
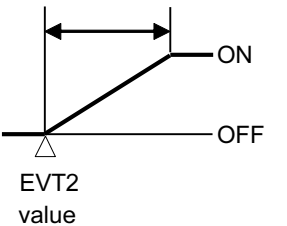
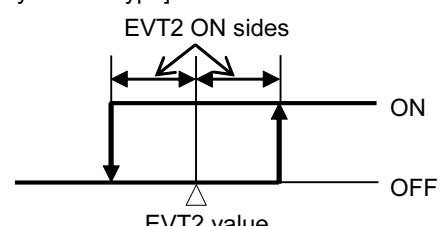
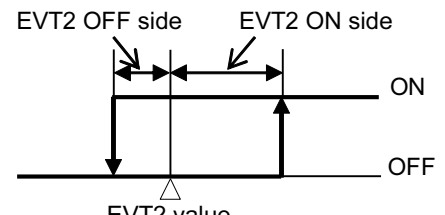
EVT2 Type	P Control Action	ON/OFF Control Action
pH input low limit action, Temperature input low limit action, ORP input low limit action	EVT2 proportional band 	If Medium Value is selected in [EVT2 hysteresis type]: 
		If Reference Value is selected in [EVT2 hysteresis type]: 
pH input high limit action, Temperature input high limit action, ORP input high limit action	EVT2 proportional band 	If Medium Value is selected in [EVT2 hysteresis type]: 
		If Reference Value is selected in [EVT2 hysteresis type]: 

(Fig. 6.7-1)

**Timing chart of EVT2 output ON time and OFF time while in EVT2 output ON**

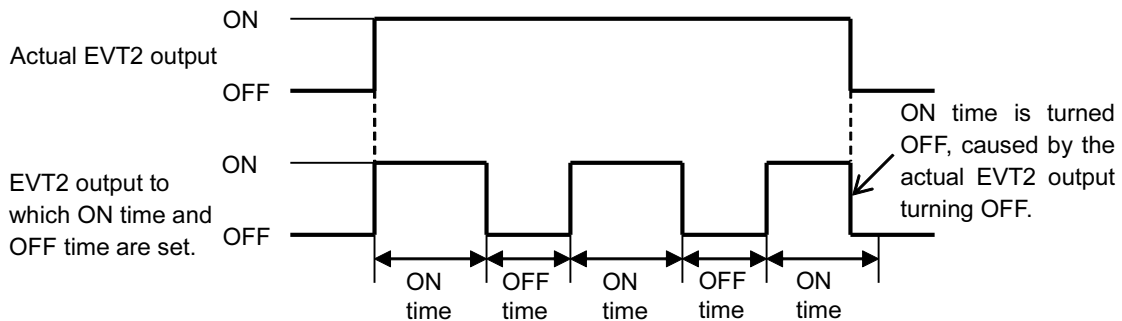

(Fig. 6.7-2)

## 6.8 EVT3 Group

Available when EVT3 option or EVT4 option is ordered.

Setting item and range differ depending on the selection in Section 6.2 Model Selection (p.18).

### 6.8.1 When Selecting pH Meter

To enter EVT3 Group, follow the procedure below.

- ① **G.PH** Press the  **MODE** key in pH-Temperature/ORP Display Mode, or Cleansing Output Mode.
- ② **G.E03** Press the  **▽** key as many times as necessary until the left characters appear.
- ③ **EVT3F** Press the  **SET** key.

The unit will enter EVT3 Group, and 'EVT3 type' will appear.

Character	Setting Item, Function, Setting Range	Factory Default																														
<b>EVT3F</b> -----	<b>EVT3 type</b> <ul style="list-style-type: none"> <li>• Selects an EVT3 output (Contact output 3) type. (Fig. 6.8-1) (p.48)</li> <li><b>Note: If EVT3 type is changed, EVT3 value will default to 0.00 or 0.0.</b></li> <li>• If <b>NONE</b> (No temperature compensation) is selected in [Electrode RTD (p.21)], and even if Temperature input low limit or high limit action is selected, the action will be disabled.</li> <li>• -----: No action</li> <li><b>pH-L</b> : pH input low limit action</li> <li><b>pH-H</b> : pH input high limit action</li> <li><b>TEMPL</b> : Temperature input low limit action</li> <li><b>TEMPH</b> : Temperature input high limit action</li> <li><b>EROUT</b> : Error output [When the error type is "Error" (Table 6.8.1-1), the output is turned ON.]</li> <li><b>FAIL</b> : Fail output [When the error type is "Fail" (Table 6.8.1-1), the output is turned ON.]</li> <li><b>CLEG</b> : Cleansing output</li> <li><b>EPUL</b> : pH input error alarm output</li> </ul> <ul style="list-style-type: none"> <li>• <b>Error output, Fail output</b> (Table 6.8.1-1)</li> </ul> <table border="1"> <thead> <tr> <th>Error Type</th> <th>Error Contents</th> <th>Description</th> </tr> </thead> <tbody> <tr> <td>Error</td> <td>Response Speed Error</td> <td>When calibrating, the response of the pH Combined Electrode Sensor is slow. With the 1st and 2nd solutions, when pH <math>\pm 0.10</math> or more of input fluctuation within pH <math>\pm 1.50</math> continues for 5 minutes.</td> </tr> <tr> <td>Error</td> <td>Electrode Sensitivity Error</td> <td>When calibrating, sensitivity of the pH Combined Electrode Sensor is deteriorating. The difference of pH measured value (after calibration) between the 1st and the 2nd point is pH 2.00 or less.</td> </tr> <tr> <td>Error</td> <td>Asymmetry Potential Error</td> <td>When calibrating pH 7, the difference in electromotive force between the sensor-measured value and standard value exceeds the equivalent of pH <math>\pm 1.50</math>.</td> </tr> <tr> <td>Error</td> <td>Standard Solution Error</td> <td>The specified standard solution has not been used. When pH <math>\pm 1.50</math> is exceeded for the 1st &amp; 2nd solutions.</td> </tr> <tr> <td>Error</td> <td>Solution Temperature Error</td> <td>When temperature is 55°C or more at pH 10 solution.</td> </tr> <tr> <td>Error</td> <td>Outside Temp. Compen. Range</td> <td>Measured temperature has exceeded 110.0°C.</td> </tr> <tr> <td>Error</td> <td>Outside Temp. Compen. Range</td> <td>Measured temperature is less than 0.0°C.</td> </tr> <tr> <td>Fail</td> <td>Temp. Sensor Burnout</td> <td>Temperature sensor lead wire is burnt out.</td> </tr> <tr> <td>Fail</td> <td>Temp. Sensor Short-circuited</td> <td>Temperature sensor lead wire is short-circuited.</td> </tr> </tbody> </table> <p>(Abbreviations: Temp.: Temperature, Compen.: Compensation)</p>	Error Type	Error Contents	Description	Error	Response Speed Error	When calibrating, the response of the pH Combined Electrode Sensor is slow. With the 1st and 2nd solutions, when pH $\pm 0.10$ or more of input fluctuation within pH $\pm 1.50$ continues for 5 minutes.	Error	Electrode Sensitivity Error	When calibrating, sensitivity of the pH Combined Electrode Sensor is deteriorating. The difference of pH measured value (after calibration) between the 1st and the 2nd point is pH 2.00 or less.	Error	Asymmetry Potential Error	When calibrating pH 7, the difference in electromotive force between the sensor-measured value and standard value exceeds the equivalent of pH $\pm 1.50$ .	Error	Standard Solution Error	The specified standard solution has not been used. When pH $\pm 1.50$ is exceeded for the 1st & 2nd solutions.	Error	Solution Temperature Error	When temperature is 55°C or more at pH 10 solution.	Error	Outside Temp. Compen. Range	Measured temperature has exceeded 110.0°C.	Error	Outside Temp. Compen. Range	Measured temperature is less than 0.0°C.	Fail	Temp. Sensor Burnout	Temperature sensor lead wire is burnt out.	Fail	Temp. Sensor Short-circuited	Temperature sensor lead wire is short-circuited.	No action
Error Type	Error Contents	Description																														
Error	Response Speed Error	When calibrating, the response of the pH Combined Electrode Sensor is slow. With the 1st and 2nd solutions, when pH $\pm 0.10$ or more of input fluctuation within pH $\pm 1.50$ continues for 5 minutes.																														
Error	Electrode Sensitivity Error	When calibrating, sensitivity of the pH Combined Electrode Sensor is deteriorating. The difference of pH measured value (after calibration) between the 1st and the 2nd point is pH 2.00 or less.																														
Error	Asymmetry Potential Error	When calibrating pH 7, the difference in electromotive force between the sensor-measured value and standard value exceeds the equivalent of pH $\pm 1.50$ .																														
Error	Standard Solution Error	The specified standard solution has not been used. When pH $\pm 1.50$ is exceeded for the 1st & 2nd solutions.																														
Error	Solution Temperature Error	When temperature is 55°C or more at pH 10 solution.																														
Error	Outside Temp. Compen. Range	Measured temperature has exceeded 110.0°C.																														
Error	Outside Temp. Compen. Range	Measured temperature is less than 0.0°C.																														
Fail	Temp. Sensor Burnout	Temperature sensor lead wire is burnt out.																														
Fail	Temp. Sensor Short-circuited	Temperature sensor lead wire is short-circuited.																														
<b>ESV3</b> <input type="checkbox"/> <b>0.00</b>	<b>EVT3 value</b> <ul style="list-style-type: none"> <li>• Sets an EVT3 value.</li> <li>• Available when <b>pH-L</b> (pH input low limit action), <b>pH-H</b> (pH input high limit action), <b>TEMPL</b> (Temperature input low limit action) or <b>TEMPH</b> (Temperature input high limit action) is selected in [EVT3 type]</li> <li>• Setting range: pH input: pH 0.00 to 14.00 (*) Temperature input: 0.0 to 100.0°C (*)</li> </ul>	pH input: pH 0.00 Temperature input: 0.0°C																														

(\*) The placement of the decimal point does not follow the selection. It is fixed.



Character	Setting Item, Function, Setting Range	Factory Default
EP3 <input type="text"/> <input type="text"/> 0.00	<b>EVT3 proportional band</b>  <ul style="list-style-type: none"> <li>Sets EVT3 proportional band. ON/OFF control when set to 0.00 or 0.0.</li> <li>Available when <b>PH-L</b> (pH input low limit action), <b>PH-H</b> (pH input high limit action), <b>TEMPL</b> (Temperature input low limit action) or <b>TEMPH</b> (Temperature input high limit action) is selected in [EVT3 type]</li> <li>Setting range: pH input: pH 0.00 to 14.00 (*) Temperature input: 0.0 to 100.0°C (*)</li> </ul>	pH input: pH 0.00 Temperature input: 0.0°C
E3RST <input type="text"/> <input type="text"/> 0.00	<b>EVT3 reset</b>  <ul style="list-style-type: none"> <li>Sets the EVT3 reset value.</li> <li>Available when <b>PH-L</b> (pH input low limit action), <b>PH-H</b> (pH input high limit action), <b>TEMPL</b> (Temperature input low limit action) or <b>TEMPH</b> (Temperature input high limit action) is selected in [EVT3 type]</li> <li>Not available for ON/OFF control.</li> <li>Setting range: pH input: pH ±4.00 (*) Temperature input: ±10.0°C (*)</li> </ul>	pH input: pH 0.00 Temperature input: 0.0°C
E3DIF <input type="text"/> SDIF <input type="text"/>	<b>EVT3 hysteresis type</b>  <ul style="list-style-type: none"> <li>Selects EVT3 output hysteresis type (Medium or Reference Value). (Fig. 6.8-1)(p.48)</li> <li>Available when <b>PH-L</b> (pH input low limit action), <b>PH-H</b> (pH input high limit action), <b>TEMPL</b> (Temperature input low limit action) or <b>TEMPH</b> (Temperature input high limit action) is selected in [EVT3 type]</li> <li>Not available for P control.</li> <li><b>CDIF</b>: Medium Value Sets the same value for both ON and OFF sides in relation to EVT3 value. Only ON side needs to be set.</li> <li><b>SDIF</b>: Reference Value Sets individual values for ON and OFF sides in relation to EVT3 value. Both ON and OFF sides need to be set individually.</li> </ul>	Reference Value
E3DF0 <input type="text"/> <input type="text"/> 0.10	<b>EVT3 ON side</b>  <ul style="list-style-type: none"> <li>Sets the span of EVT3 ON side. (Fig. 6.8-1)(p.48) If <b>CDIF</b> (Medium Value) is selected in [EVT3 hysteresis type], the span of ON/OFF side will be the same value.</li> <li>Available when <b>PH-L</b> (pH input low limit action), <b>PH-H</b> (pH input high limit action), <b>TEMPL</b> (Temperature input low limit action) or <b>TEMPH</b> (Temperature input high limit action) is selected in [EVT3 type]</li> <li>Not available for P control.</li> <li>Setting range: pH input: pH 0.00 to 4.00 (*) Temperature input: 0.0 to 10.0°C (*)</li> </ul>	pH input: pH 0.10 Temperature input: 1.0°C
E3DFU <input type="text"/> <input type="text"/> 0.10	<b>EVT3 OFF side</b>  <ul style="list-style-type: none"> <li>Sets the span of EVT3 OFF side. (Fig. 6.8-1)(p.48)</li> <li>Available when <b>PH-L</b> (pH input low limit action), <b>PH-H</b> (pH input high limit action), <b>TEMPL</b> (Temperature input low limit action) or <b>TEMPH</b> (Temperature input high limit action) is selected in [EVT3 type]</li> <li>Available when <b>SDIF</b> (Reference Value) is selected in [EVT3 hysteresis type]. Not available for P control.</li> <li>Setting range: pH input: pH 0.00 to 4.00 (*) Temperature input: 0.0 to 10.0°C (*)</li> </ul>	pH input: pH 0.10 Temperature input: 1.0°C

(\*) The placement of the decimal point does not follow the selection. It is fixed.

Character	Setting Item, Function, Setting Range	Factory Default
E30NT □□□□□0	<b>EVT3 ON delay time</b> • Sets EVT3 ON delay time. The EVT3 output does not turn ON (under the conditions of turning ON) until the time set in [EVT3 ON delay time] elapses. • Available when <b>pH-L</b> (pH input low limit action), <b>pH-H</b> (pH input high limit action), <b>TEMP-L</b> (Temperature input low limit action) or <b>TEMP-H</b> (Temperature input high limit action) is selected in [EVT3 type] • Not available for P control. • Setting range: 0 to 10000 seconds	0 sec.
E30FT □□□□□0	<b>EVT3 OFF delay time</b> • Sets EVT3 OFF delay time. The EVT3 output does not turn OFF (under the conditions of turning OFF) until the time set in [EVT3 OFF delay time] elapses. • Available when <b>pH-L</b> (pH input low limit action), <b>pH-H</b> (pH input high limit action), <b>TEMP-L</b> (Temperature input low limit action) or <b>TEMP-H</b> (Temperature input high limit action) is selected in [EVT3 type] • Not available for P control. • Setting range: 0 to 10000 seconds	0 sec.
E30C □□□□30	<b>EVT3 proportional cycle</b> • Sets proportional cycle for EVT3. • Available when <b>pH-L</b> (pH input low limit action), <b>pH-H</b> (pH input high limit action), <b>TEMP-L</b> (Temperature input low limit action) or <b>TEMP-H</b> (Temperature input high limit action) is selected in [EVT3 type] • Not available for ON/OFF control. • Setting range: 1 to 300 seconds	30 sec.
E30LH □□□□100	<b>EVT3 output high limit</b> • Sets EVT3 output high limit value. • Available when <b>pH-L</b> (pH input low limit action), <b>pH-H</b> (pH input high limit action), <b>TEMP-L</b> (Temperature input low limit action) or <b>TEMP-H</b> (Temperature input high limit action) is selected in [EVT3 type] • Not available for ON/OFF control. • Setting range: EVT3 output low limit value to 100%	100%
E30LL □□□□□0	<b>EVT3 output low limit</b> • Sets EVT3 output low limit value. • Available when <b>pH-L</b> (pH input low limit action), <b>pH-H</b> (pH input high limit action), <b>TEMP-L</b> (Temperature input low limit action) or <b>TEMP-H</b> (Temperature input high limit action) is selected in [EVT3 type] • Not available for ON/OFF control. • Setting range: 0% to EVT3 output high limit value	0%
00NT3 □□□□□0	<b>Output ON time when EVT3 output ON</b> • Sets Output ON time when EVT3 output is ON. If Output ON time and OFF time are set, EVT3 output can be turned ON/OFF in a configured cycle when EVT3 output is ON. (Fig. 6.8-2)(p.48) • Available when <b>pH-L</b> (pH input low limit action), <b>pH-H</b> (pH input high limit action), <b>TEMP-L</b> (Temperature input low limit action) or <b>TEMP-H</b> (Temperature input high limit action) is selected in [EVT3 type] • Not available for P control. • Setting range: 0 to 10000 seconds	0 sec.

Character	Setting Item, Function, Setting Range	Factory Default
00FT3 00000 0	<b>Output OFF time when EVT3 output ON</b> <ul style="list-style-type: none"> <li>Sets Output OFF time when EVT3 output is ON.</li> <li>If Output ON time and OFF time are set, EVT3 output can be turned ON/OFF in a configured cycle when EVT3 output is ON. (Fig. 6.8-2)(p.48)</li> <li>Available when <b>pH-L</b> (pH input low limit action), <b>pH-H</b> (pH input high limit action), <b>TEMP-L</b> (Temperature input low limit action) or <b>TEMP-H</b> (Temperature input high limit action) is selected in [EVT3 type]</li> <li>Not available for P control.</li> <li>Setting range: 0 to 10000 seconds</li> </ul>	0 sec.
E3CS -----	<b>EVT3 pH input error alarm EVT type</b> <ul style="list-style-type: none"> <li>Selects an EVT type (except EVT3 type) in order to assess EVT3 pH input error alarm.</li> <li>Available only when <b>EPUL</b> (pH input error alarm output) is selected in [EVT3 type]</li> <li>Selection item  <b>EVT1</b> : EVT1 type  <b>EVT2</b> : EVT2 type  <b>-----</b> : No action  <b>EVT4</b> : EVT4 type</li> </ul>	No action
E3P0 0000 0.0	<b>EVT3 pH input error alarm span when EVT output ON</b> <ul style="list-style-type: none"> <li>Sets span to assess EVT3 pH input error alarm when EVT output is ON – which is selected in [EVT3 pH input error alarm EVT type].</li> <li>Available only when <b>EPUL</b> (pH input error alarm output) is selected in [EVT3 type]</li> <li>Setting range: pH 0.0 to 14.0 When set to 0.0, pH input error alarm is disabled.</li> </ul>	pH 0.0
E3POT 00000 0	<b>EVT3 pH input error alarm time when EVT output ON</b> <ul style="list-style-type: none"> <li>Sets time to assess EVT3 pH input error alarm when EVT output is ON – which is selected in [EVT3 pH input error alarm EVT type].</li> <li>Available only when <b>EPUL</b> (pH input error alarm output) is selected in [EVT3 type]</li> <li>Setting range: 0 to 10000 seconds or minutes (Time unit follows the selection in [pH/ORP input error alarm time unit].) When set to 0, pH input error alarm is disabled.</li> </ul>	0 sec.
E3PC 0000 0.0	<b>EVT3 pH input error alarm span when EVT output OFF</b> <ul style="list-style-type: none"> <li>Sets span to assess EVT3 pH input error alarm when EVT output is OFF – which is selected in [EVT3 pH input error alarm EVT type].</li> <li>Available only when <b>EPUL</b> (pH input error alarm output) is selected in [EVT3 type]</li> <li>Setting range: pH 0.0 to 14.0 When set to 0.0, pH input error alarm is disabled.</li> </ul>	pH 0.0

Character	Setting Item, Function, Setting Range	Factory Default
<b>E3PCT</b> □□□□□0	<b>EVT3 pH input error alarm time when EVT□ output OFF</b> <ul style="list-style-type: none"> <li>• Sets time to assess EVT3 pH input error alarm when EVT□ output is OFF – which is selected in [EVT3 pH input error alarm EVT□ type].</li> <li>• Available only when <b>EPUL</b>□□ (pH input error alarm output) is selected in [EVT3 type]</li> <li>• Setting range: 0 to 10000 seconds or minutes (Time unit follows the selection in [pH/ORP input error alarm time unit].) When set to 0, pH input error alarm is disabled.</li> </ul>	0 sec.
<b>MVZN3</b> □□□50.0	<b>EVT3 cycle variable range</b> <ul style="list-style-type: none"> <li>• Sets EVT3 cycle range to be changed.</li> <li>• Available when <b>PH-L</b>□□ (pH input low limit action), <b>PH-H</b>□□ (pH input high limit action), <b>TEMPL</b>□ (Temperature input low limit action) or <b>TEMPH</b>□ (Temperature input high limit action) is selected in [EVT3 type]</li> <li>• Not available for ON/OFF control.</li> <li>• Setting range: 1.0 to 100.0%</li> </ul>	50.0%
<b>CENT3</b> □□□□□0	<b>EVT3 cycle extended time</b> <ul style="list-style-type: none"> <li>• Sets time to extend EVT3 cycle.</li> <li>• Available when <b>PH-L</b>□□ (pH input low limit action), <b>PH-H</b>□□ (pH input high limit action), <b>TEMPL</b>□ (Temperature input low limit action) or <b>TEMPH</b>□ (Temperature input high limit action) is selected in [EVT3 type]</li> <li>• Not available for ON/OFF control.</li> <li>• Setting range: 0 to 300 seconds</li> </ul>	0 sec.

### 6.8.2 When Selecting ORP Meter

To enter EVT3 Group, follow the procedure below.

- ① **G\_ORP** Press the  MODE key in pH-Temperature/ORP Display Mode, or Cleansing Output Mode.
- ② **G\_E03** Press the  ▽ key as many times as necessary until the left characters appear.
- ③ **EVT3F** Press the  SET key.

The unit will enter EVT3 Group, and 'EVT3 type' will appear.

Character	Setting Item, Function, Setting Range	Factory Default
<b>EVT3F</b> -----	<b>EVT3 type</b> <ul style="list-style-type: none"> <li>• Selects an EVT3 output (Contact output 3) type. (Fig. 6.8-1)(p.48)</li> <li><b>Note: If EVT3 type is changed, EVT3 value will default to 0.</b></li> <li>• ----- : No action</li> <li>• <b>ORP-L</b>□ : ORP input low limit action</li> <li>• <b>ORP-H</b>□ : ORP input high limit action</li> <li>• <b>CLEG</b>□□ : Cleansing output</li> <li>• <b>EOUL</b>□□ : ORP input error alarm output</li> </ul>	No action
<b>ESV3</b> □ □□□□□0	<b>EVT3 value</b> <ul style="list-style-type: none"> <li>• Selects an EVT3 value.</li> <li>• Available when <b>ORP-L</b>□ (ORP input low limit action) or <b>ORP-H</b>□ (ORP input high limit action) is selected in [EVT3 type].</li> <li>• Setting range: Input low limit to Input high limit</li> </ul>	0 mV
<b>EP3</b> □□ □□□□□0	<b>EVT3 proportional band</b> <ul style="list-style-type: none"> <li>• Sets EVT3 proportional band.</li> <li>• ON/OFF control when set to 0.</li> <li>• Available when <b>ORP-L</b>□ (ORP input low limit action) or <b>ORP-H</b>□ (ORP input high limit action) is selected in [EVT3 type].</li> <li>• Setting range: 0 to Input span</li> </ul>	0 mV

Character	Setting Item, Function, Setting Range	Factory Default
E3RST □□□□0	<b>EVT3 reset</b> <ul style="list-style-type: none"> <li>• Sets the EVT3 reset value.</li> <li>• Available when <b>ORP-L</b> (ORP input low limit action) or <b>ORP-H</b> (ORP input high limit action) is selected in [EVT3 type].</li> <li>• Not available for ON/OFF control.</li> <li>• Setting range: ±200 mV</li> </ul>	0 mV
E3DIF SDIF□□	<b>EVT3 hysteresis type</b> <ul style="list-style-type: none"> <li>• Selects EVT3 output hysteresis type (Medium or Reference Value). (Fig. 6.8-1)(p.48)</li> <li>• Available when <b>ORP-L</b> (ORP input low limit action) or <b>ORP-H</b> (ORP input high limit action) is selected in [EVT3 type].</li> <li>• Not available for P control.</li> <li>• <b>CDIF</b>□□: Medium Value Sets the same value for both ON and OFF sides in relation to EVT3 value. Only ON side needs to be set.</li> <li>• <b>SDIF</b>□□: Reference Value Sets individual values for ON and OFF sides in relation to EVT3 value. Both ON and OFF sides need to be set individually.</li> </ul>	Reference Value
E3DF0 □□□□10	<b>EVT3 ON side</b> <ul style="list-style-type: none"> <li>• Sets the span of EVT3 ON side. (Fig. 6.8-1)(p.48)</li> <li>• If <b>CDIF</b>□□ (Medium Value) is selected in [EVT3 hysteresis type], the span of ON/OFF side will be the same value.</li> <li>• Available when <b>ORP-L</b> (ORP input low limit action) or <b>ORP-H</b> (ORP input high limit action) is selected in [EVT3 type].</li> <li>• Not available for P control.</li> <li>• Setting range: 0 to 200 mV</li> </ul>	10 mV
E3DFU □□□□10	<b>EVT3 OFF side</b> <ul style="list-style-type: none"> <li>• Sets the span of EVT3 OFF side. (Fig. 6.8-1)(p.48)</li> <li>• Available when <b>ORP-L</b> (ORP input low limit action) or <b>ORP-H</b> (ORP input high limit action) is selected in [EVT3 type].</li> <li>• Available when <b>SDIF</b>□□ (Reference Value) is selected in [EVT3 hysteresis type].</li> <li>• Not available for P control.</li> <li>• Setting range: 0 to 200 mV</li> </ul>	10 mV
E3ONT □□□□0	<b>EVT3 ON delay time</b> <ul style="list-style-type: none"> <li>• Sets EVT3 ON delay time.</li> <li>• The EVT3 output does not turn ON (under the conditions of turning ON) until the time set in [EVT3 ON delay time] elapses.</li> <li>• Available when <b>ORP-L</b> (ORP input low limit action) or <b>ORP-H</b> (ORP input high limit action) is selected in [EVT3 type].</li> <li>• Not available for P control.</li> <li>• Setting range: 0 to 10000 seconds</li> </ul>	0 sec.
E3OFT □□□□0	<b>EVT3 OFF delay time</b> <ul style="list-style-type: none"> <li>• Sets EVT3 OFF delay time.</li> <li>• The EVT3 output does not turn OFF (under the conditions of turning OFF) until the time set in [EVT3 OFF delay time] elapses.</li> <li>• Available when <b>ORP-L</b> (ORP input low limit action) or <b>ORP-H</b> (ORP input high limit action) is selected in [EVT3 type].</li> <li>• Not available for P control.</li> <li>• Setting range: 0 to 10000 seconds</li> </ul>	0 sec.

Character	Setting Item, Function, Setting Range	Factory Default
E3C□□ □□□□30	<b>EVT3 proportional cycle</b> <ul style="list-style-type: none"> <li>• Sets proportional cycle for EVT3.</li> <li>• Available when <b>ORP-L</b>□ (ORP input low limit action) or <b>ORP-H</b>□ (ORP input high limit action) is selected in [EVT3 type].</li> <li>• Not available for ON/OFF control.</li> <li>• Setting range: 1 to 300 seconds</li> </ul>	30 sec.
E30LH □□□100	<b>EVT3 output high limit</b> <ul style="list-style-type: none"> <li>• Sets EVT3 output high limit value.</li> <li>• Available when <b>ORP-L</b>□ (ORP input low limit action) or <b>ORP-H</b>□ (ORP input high limit action) is selected in [EVT3 type].</li> <li>• Not available for ON/OFF control.</li> <li>• Setting range: EVT3 output low limit value to 100%</li> </ul>	100%
E30LL □□□□0	<b>EVT3 output low limit</b> <ul style="list-style-type: none"> <li>• Sets EVT3 output low limit value.</li> <li>• Available when <b>ORP-L</b>□ (ORP input low limit action) or <b>ORP-H</b>□ (ORP input high limit action) is selected in [EVT3 type].</li> <li>• Not available for ON/OFF control.</li> <li>• Setting range: 0% to EVT3 output high limit value</li> </ul>	0%
00NT3 □□□□0	<b>Output ON time when EVT3 output ON</b> <ul style="list-style-type: none"> <li>• Sets Output ON time when EVT3 output is ON.</li> <li>• If ON time and OFF time are set, EVT3 output can be turned ON/OFF in a configured cycle when EVT3 output is ON. (Fig. 6.8-2)(p.48)</li> <li>• Available when <b>ORP-L</b>□ (ORP input low limit action) or <b>ORP-H</b>□ (ORP input high limit action) is selected in [EVT3 type].</li> <li>• Not available for P control.</li> <li>• Setting range: 0 to 10000 seconds</li> </ul>	0 sec.
00FT3 □□□□0	<b>Output OFF time when EVT3 output ON</b> <ul style="list-style-type: none"> <li>• Sets Output OFF time when EVT3 output is ON.</li> <li>• If ON time and OFF time are set, EVT3 output can be turned ON/OFF in a configured cycle when EVT3 output is ON. (Fig. 6.8-2)(p.48)</li> <li>• Available when <b>ORP-L</b>□ (ORP input low limit action) or <b>ORP-H</b>□ (ORP input high limit action) is selected in [EVT3 type].</li> <li>• Not available for P control.</li> <li>• Setting range: 0 to 10000 seconds</li> </ul>	0 sec.
E3CS□ -----	<b>EVT3 ORP input error alarm EVT□ type</b> <ul style="list-style-type: none"> <li>• Selects an EVT□ type (except EVT3 type) in order to assess EVT3 ORP input error alarm.</li> <li>• Available only when <b>EOUL</b>□□ (ORP input error alarm output) is selected in [EVT3 type]</li> <li>• Selection item  <b>EVT1</b>□□ : EVT1 type  <b>EVT2</b>□□ : EVT2 type  ----- : No action  <b>EVT4</b>□□ : EVT4 type </li> </ul>	No action
E300□ □□□□0	<b>EVT3 ORP input error alarm span when EVT□ output ON</b> <ul style="list-style-type: none"> <li>• Sets span to assess EVT3 ORP input error alarm when EVT□ output is ON – which is selected in [EVT3 ORP input error alarm EVT□ type].</li> <li>• Available only when <b>EOUL</b>□□ (ORP input error alarm output) is selected in [EVT3 type]</li> <li>• Setting range: 0 to 2000 mV When set to 0, ORP input error alarm is disabled.</li> </ul>	0 mV

Character	Setting Item, Function, Setting Range	Factory Default
E300T □□□□□0	<b>EVT3 ORP input error alarm time when EVT□ output ON</b> <ul style="list-style-type: none"> <li>• Sets time to assess EVT3 ORP input error alarm when EVT□ output is ON – which is selected in [EVT3 ORP input error alarm EVT□ type].</li> <li>• Available only when <b>E0UL</b>□□ (ORP input error alarm output) is selected in [EVT3 type]</li> <li>• Setting range: 0 to 10000 seconds or minutes (Time unit follows the selection in [pH/ORP input error alarm time unit].) When set to 0, ORP input error alarm is disabled.</li> </ul>	0 sec.
E300□ □□□□□0	<b>EVT3 ORP input error alarm span when EVT□ output OFF</b> <ul style="list-style-type: none"> <li>• Sets span to assess EVT3 ORP input error alarm when EVT□ output is OFF – which is selected in [EVT3 ORP input error alarm EVT□ type].</li> <li>• Available only when <b>E0UL</b>□□ (ORP input error alarm output) is selected in [EVT3 type]</li> <li>• Setting range: 0 to 2000 mV When set to 0, ORP input error alarm is disabled.</li> </ul>	0 mV
E300T □□□□□0	<b>EVT3 ORP input error alarm time when EVT□ output OFF</b> <ul style="list-style-type: none"> <li>• Sets time to assess EVT3 ORP input error alarm when EVT□ output is OFF – which is selected in [EVT3 ORP input error alarm EVT□ type].</li> <li>• Available only when <b>E0UL</b>□□ (ORP input error alarm output) is selected in [EVT3 type]</li> <li>• Setting range: 0 to 10000 seconds or minutes (Time unit follows the selection in [pH/ORP input error alarm time unit].) When set to 0, ORP input error alarm is disabled.</li> </ul>	0 sec.
MVZN3 □□□50.0	<b>EVT3 cycle variable range</b> <ul style="list-style-type: none"> <li>• Sets EVT3 cycle range to be changed.</li> <li>• Available when <b>ORP-L</b>□ (ORP input low limit action) or <b>ORP-H</b>□ (ORP input high limit action) is selected in [EVT3 type].</li> <li>• Not available for ON/OFF control.</li> <li>• Setting range: 1.0 to 100.0%</li> </ul>	50.0%
CENT3 □□□□□0	<b>EVT3 cycle extended time</b> <ul style="list-style-type: none"> <li>• Sets time to extend EVT3 cycle.</li> <li>• Available when <b>ORP-L</b>□ (ORP input low limit action) or <b>ORP-H</b>□ (ORP input high limit action) is selected in [EVT3 type].</li> <li>• Not available for ON/OFF control.</li> <li>• Setting range: 0 to 300 seconds</li> </ul>	0 sec.

**EVT3 Action**

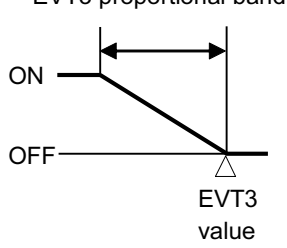
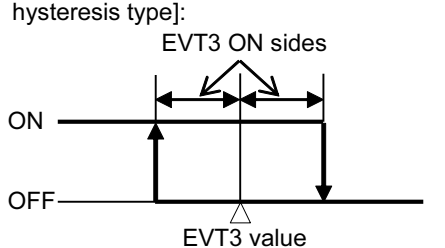
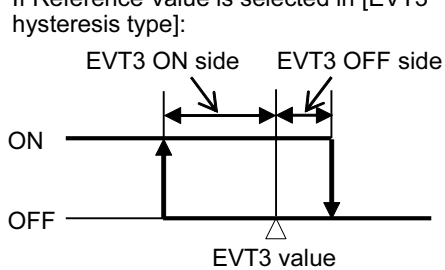
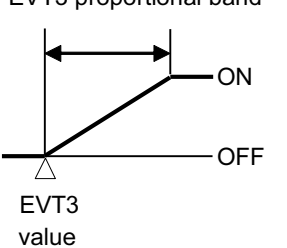
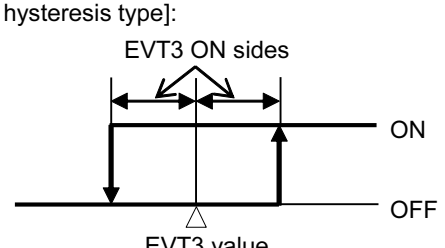
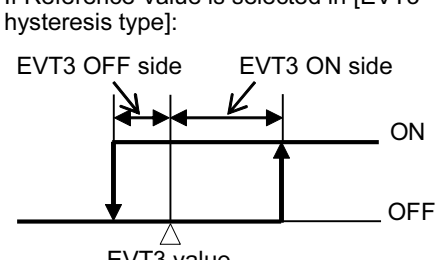
EVT3 Type	P Control Action	ON/OFF Control Action
pH input low limit action, Temperature input low limit action, ORP input low limit action	EVT3 proportional band 	If Medium Value is selected in [EVT3 hysteresis type]: 
		If Reference Value is selected in [EVT3 hysteresis type]: 
pH input high limit action, Temperature input high limit action, ORP input high limit action	EVT3 proportional band 	If Medium Value is selected in [EVT3 hysteresis type]: 
		If Reference Value is selected in [EVT3 hysteresis type]: 

(Fig. 6.8-1)

**Timing chart of EVT3 output ON time and OFF time while in EVT3 output ON**

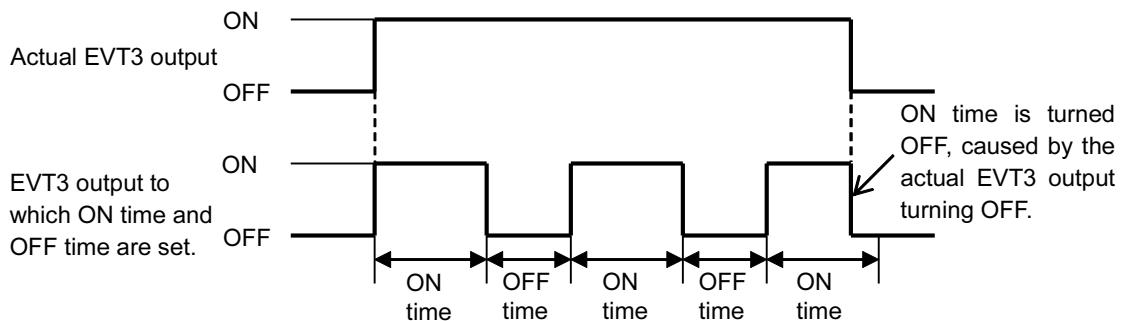

(Fig. 6.8-2)



## 6.9 EVT4 Group

Available only when EVT4 option is ordered.

Setting item and range differ depending on the selection in Section 6.2 Model Selection (p.18).

### 6.9.1 When Selecting pH Meter

To enter EVT4 Group, follow the procedure below.

- ① **G\_PH** Press the **MODE** key in pH-Temperature/ORP Display Mode, or Cleansing Output Mode.
- ② **G\_E04** Press the **▽** key as many times as necessary until the left characters appear.
- ③ **EVT4F** Press the **SET** key.

The unit will enter EVT4 Group, and 'EVT4 type' will appear.

Character	Setting Item, Function, Setting Range	Factory Default																														
<b>EVT4F</b> -----	<b>EVT4 type</b> <ul style="list-style-type: none"> <li>• Selects an EVT4 output (Contact output 4) type. (Fig. 6.9-1) (p.57)</li> <li><b>Note: If EVT4 type is changed, EVT4 value will default to 0.00 or 0.0.</b></li> <li>• If <b>NONE</b> (No temperature compensation) is selected in [Electrode RTD (p.21)], and even if Temperature input low limit or high limit action is selected, the action will be disabled.</li> <li>• -----: No action</li> <li><b>pH-L</b> : pH input low limit action</li> <li><b>pH-H</b> : pH input high limit action</li> <li><b>TEMPL</b> : Temperature input low limit action</li> <li><b>TEMPH</b> : Temperature input high limit action</li> <li><b>EROUT</b> : Error output [When the error type is "Error" (Table 6.9.1-1), the output is turned ON.]</li> <li><b>FAIL</b> : Fail output [When the error type is "Fail" (Table 6.9.1-1), the output is turned ON.]</li> <li><b>CLEG</b> : Cleansing output</li> <li><b>EPUL</b> : pH input error alarm output</li> <li>• <b>Error output, Fail output</b> (Table 6.9.1-1)</li> </ul> <table border="1"> <thead> <tr> <th>Error Type</th> <th>Error Contents</th> <th>Description</th> </tr> </thead> <tbody> <tr> <td>Error</td> <td>Response Speed Error</td> <td>When calibrating, the response of the pH Combined Electrode Sensor is slow. With the 1st and 2nd solutions, when pH <math>\pm 0.10</math> or more of input fluctuation within pH <math>\pm 1.50</math> continues for 5 minutes.</td> </tr> <tr> <td>Error</td> <td>Electrode Sensitivity Error</td> <td>When calibrating, sensitivity of the pH Combined Electrode Sensor is deteriorating. The difference of pH measured value (after calibration) between the 1st and the 2nd point is pH 2.00 or less.</td> </tr> <tr> <td>Error</td> <td>Asymmetry Potential Error</td> <td>When calibrating pH 7, the difference in electromotive force between the sensor-measured value and standard value exceeds the equivalent of pH <math>\pm 1.50</math>.</td> </tr> <tr> <td>Error</td> <td>Standard Solution Error</td> <td>The specified standard solution has not been used. When pH <math>\pm 1.50</math> is exceeded for the 1st &amp; 2nd solutions.</td> </tr> <tr> <td>Error</td> <td>Solution Temperature Error</td> <td>When temperature is 55°C or more at pH 10 solution.</td> </tr> <tr> <td>Error</td> <td>Outside Temp. Compen. Range</td> <td>Measured temperature has exceeded 110.0°C.</td> </tr> <tr> <td>Error</td> <td>Outside Temp. Compen. Range</td> <td>Measured temperature is less than 0.0°C.</td> </tr> <tr> <td>Fail</td> <td>Temp. Sensor Burnout</td> <td>Temperature sensor lead wire is burnt out.</td> </tr> <tr> <td>Fail</td> <td>Temp. Sensor Short-circuited</td> <td>Temperature sensor lead wire is short-circuited.</td> </tr> </tbody> </table> <p>(Abbreviations: Temp.: Temperature, Compen.: Compensation)</p>	Error Type	Error Contents	Description	Error	Response Speed Error	When calibrating, the response of the pH Combined Electrode Sensor is slow. With the 1st and 2nd solutions, when pH $\pm 0.10$ or more of input fluctuation within pH $\pm 1.50$ continues for 5 minutes.	Error	Electrode Sensitivity Error	When calibrating, sensitivity of the pH Combined Electrode Sensor is deteriorating. The difference of pH measured value (after calibration) between the 1st and the 2nd point is pH 2.00 or less.	Error	Asymmetry Potential Error	When calibrating pH 7, the difference in electromotive force between the sensor-measured value and standard value exceeds the equivalent of pH $\pm 1.50$ .	Error	Standard Solution Error	The specified standard solution has not been used. When pH $\pm 1.50$ is exceeded for the 1st & 2nd solutions.	Error	Solution Temperature Error	When temperature is 55°C or more at pH 10 solution.	Error	Outside Temp. Compen. Range	Measured temperature has exceeded 110.0°C.	Error	Outside Temp. Compen. Range	Measured temperature is less than 0.0°C.	Fail	Temp. Sensor Burnout	Temperature sensor lead wire is burnt out.	Fail	Temp. Sensor Short-circuited	Temperature sensor lead wire is short-circuited.	No action
Error Type	Error Contents	Description																														
Error	Response Speed Error	When calibrating, the response of the pH Combined Electrode Sensor is slow. With the 1st and 2nd solutions, when pH $\pm 0.10$ or more of input fluctuation within pH $\pm 1.50$ continues for 5 minutes.																														
Error	Electrode Sensitivity Error	When calibrating, sensitivity of the pH Combined Electrode Sensor is deteriorating. The difference of pH measured value (after calibration) between the 1st and the 2nd point is pH 2.00 or less.																														
Error	Asymmetry Potential Error	When calibrating pH 7, the difference in electromotive force between the sensor-measured value and standard value exceeds the equivalent of pH $\pm 1.50$ .																														
Error	Standard Solution Error	The specified standard solution has not been used. When pH $\pm 1.50$ is exceeded for the 1st & 2nd solutions.																														
Error	Solution Temperature Error	When temperature is 55°C or more at pH 10 solution.																														
Error	Outside Temp. Compen. Range	Measured temperature has exceeded 110.0°C.																														
Error	Outside Temp. Compen. Range	Measured temperature is less than 0.0°C.																														
Fail	Temp. Sensor Burnout	Temperature sensor lead wire is burnt out.																														
Fail	Temp. Sensor Short-circuited	Temperature sensor lead wire is short-circuited.																														
<b>ESV4</b> 0.00	<b>EVT4 value</b> <ul style="list-style-type: none"> <li>• Sets an EVT4 value.</li> <li>• Available when <b>pH-L</b> (pH input low limit action), <b>pH-H</b> (pH input high limit action), <b>TEMPL</b> (Temperature input low limit action) or <b>TEMPH</b> (Temperature input high limit action) is selected in [EVT4 type]</li> <li>• Setting range: pH input: pH 0.00 to 14.00 (*) Temperature input: 0.0 to 100.0°C (*)</li> </ul>	pH input: pH 0.00 Temperature input: 0.0°C																														

(\*) The placement of the decimal point does not follow the selection. It is fixed.

Character	Setting Item, Function, Setting Range	Factory Default
EP4 0.00	<b>EVT4 proportional band</b>  <ul style="list-style-type: none"> <li>Sets EVT4 proportional band. ON/OFF control when set to 0.00 or 0.0.</li> <li>Available when <b>PH-L</b> (pH input low limit action), <b>PH-H</b> (pH input high limit action), <b>TEMPL</b> (Temperature input low limit action) or <b>TEMPH</b> (Temperature input high limit action) is selected in [EVT4 type]</li> <li>Setting range: pH input: pH 0.00 to 14.00 (*) Temperature input: 0.0 to 100.0°C (*)</li> </ul>	pH input: pH 0.00 Temperature input: 0.0°C
E4RST 0.00	<b>EVT4 reset</b>  <ul style="list-style-type: none"> <li>Sets the EVT4 reset value.</li> <li>Available when <b>PH-L</b> (pH input low limit action), <b>PH-H</b> (pH input high limit action), <b>TEMPL</b> (Temperature input low limit action) or <b>TEMPH</b> (Temperature input high limit action) is selected in [EVT4 type]</li> <li>Not available for ON/OFF control.</li> <li>Setting range: pH input: pH ±4.00 (*) Temperature input: ±10.0°C (*)</li> </ul>	pH input: pH 0.00 Temperature input: 0.0°C
E4DIF SDIF	<b>EVT4 hysteresis type</b>  <ul style="list-style-type: none"> <li>Selects EVT4 output hysteresis type (Medium or Reference Value). (Fig. 6.9-1)(p.57)</li> <li>Available when <b>PH-L</b> (pH input low limit action), <b>PH-H</b> (pH input high limit action), <b>TEMPL</b> (Temperature input low limit action) or <b>TEMPH</b> (Temperature input high limit action) is selected in [EVT4 type]</li> <li>Not available for P control.</li> <li><b>CDIF</b>: Medium Value Sets the same value for both ON and OFF sides in relation to EVT4 value. Only ON side needs to be set.</li> <li><b>SDIF</b>: Reference Value Sets individual values for ON and OFF sides in relation to EVT4 value. Both ON and OFF sides need to be set individually.</li> </ul>	Reference Value
E4DF0 0.10	<b>EVT4 ON side</b>  <ul style="list-style-type: none"> <li>Sets the span of EVT4 ON side. (Fig. 6.9-1)(p.57) If <b>CDIF</b> (Medium Value) is selected in [EVT4 hysteresis type], the span of ON/OFF side will be the same value.</li> <li>Available when <b>PH-L</b> (pH input low limit action), <b>PH-H</b> (pH input high limit action), <b>TEMPL</b> (Temperature input low limit action) or <b>TEMPH</b> (Temperature input high limit action) is selected in [EVT4 type]</li> <li>Not available for P control.</li> <li>Setting range: pH input: pH 0.00 to 4.00 (*) Temperature input: 0.0 to 10.0°C (*)</li> </ul>	pH input: pH 0.10 Temperature input: 1.0°C
E4DFU 0.10	<b>EVT4 OFF side</b>  <ul style="list-style-type: none"> <li>Sets the span of EVT4 OFF side. (Fig. 6.9-1)(p.57)</li> <li>Available when <b>PH-L</b> (pH input low limit action), <b>PH-H</b> (pH input high limit action), <b>TEMPL</b> (Temperature input low limit action) or <b>TEMPH</b> (Temperature input high limit action) is selected in [EVT4 type]</li> <li>Available when <b>SDIF</b> (Reference Value) is selected in [EVT4 hysteresis type]. Not available for P control.</li> <li>Setting range: pH input: pH 0.00 to 4.00 (*) Temperature input: 0.0 to 10.0°C (*)</li> </ul>	pH input: pH 0.10 Temperature input: 1.0°C

(\*) The placement of the decimal point does not follow the selection. It is fixed.

Character	Setting Item, Function, Setting Range	Factory Default
<b>E40NT</b> □□□□□0	<b>EVT4 ON delay time</b> • Sets EVT4 ON delay time. The EVT4 output does not turn ON (under the conditions of turning ON) until the time set in [EVT4 ON delay time] elapses. • Available when <b>pH-L</b> (pH input low limit action), <b>pH-H</b> (pH input high limit action), <b>TEMP-L</b> (Temperature input low limit action) or <b>TEMP-H</b> (Temperature input high limit action) is selected in [EVT4 type] • Not available for P control. • Setting range: 0 to 10000 seconds	0 sec.
<b>E40FT</b> □□□□□0	<b>EVT4 OFF delay time</b> • Sets EVT4 OFF delay time. The EVT4 output does not turn OFF (under the conditions of turning OFF) until the time set in [EVT4 OFF delay time] elapses. • Available when <b>pH-L</b> (pH input low limit action), <b>pH-H</b> (pH input high limit action), <b>TEMP-L</b> (Temperature input low limit action) or <b>TEMP-H</b> (Temperature input high limit action) is selected in [EVT4 type] • Not available for P control. • Setting range: 0 to 10000 seconds	0 sec.
<b>E4C</b> □ □□□□30	<b>EVT4 proportional cycle</b> • Sets proportional cycle for EVT4. • Available when <b>pH-L</b> (pH input low limit action), <b>pH-H</b> (pH input high limit action), <b>TEMP-L</b> (Temperature input low limit action) or <b>TEMP-H</b> (Temperature input high limit action) is selected in [EVT4 type] • Not available for ON/OFF control. • Setting range: 1 to 300 seconds	30 sec.
<b>E40LH</b> □□□□100	<b>EVT4 output high limit</b> • Sets EVT4 output high limit value. • Available when <b>pH-L</b> (pH input low limit action), <b>pH-H</b> (pH input high limit action), <b>TEMP-L</b> (Temperature input low limit action) or <b>TEMP-H</b> (Temperature input high limit action) is selected in [EVT4 type] • Not available for ON/OFF control. • Setting range: EVT4 output low limit value to 100%	100%
<b>E40LL</b> □□□□□0	<b>EVT4 output low limit</b> • Sets EVT4 output low limit value. • Available when <b>pH-L</b> (pH input low limit action), <b>pH-H</b> (pH input high limit action), <b>TEMP-L</b> (Temperature input low limit action) or <b>TEMP-H</b> (Temperature input high limit action) is selected in [EVT4 type] • Not available for ON/OFF control. • Setting range: 0% to EVT4 output high limit value	0%
<b>OONT4</b> □□□□□0	<b>Output ON time when EVT4 output ON</b> • Sets Output ON time when EVT4 output is ON. If Output ON time and OFF time are set, EVT4 output can be turned ON/OFF in a configured cycle when EVT4 output is ON. (Fig. 6.9-2)(p.57) • Available when <b>pH-L</b> (pH input low limit action), <b>pH-H</b> (pH input high limit action), <b>TEMP-L</b> (Temperature input low limit action) or <b>TEMP-H</b> (Temperature input high limit action) is selected in [EVT4 type] • Not available for P control. • Setting range: 0 to 10000 seconds	0 sec.

Character	Setting Item, Function, Setting Range	Factory Default
00FT4 □□□□□0	<b>Output OFF time when EVT4 output ON</b> • Sets Output OFF time when EVT4 output is ON. If Output ON time and OFF time are set, EVT4 output can be turned ON/OFF in a configured cycle when EVT4 output is ON. (Fig. 6.9-2)(p.57) • Available when <b>pH-L</b> □□ (pH input low limit action), <b>pH-H</b> □□ (pH input high limit action), <b>TEMP-L</b> □ (Temperature input low limit action) or <b>TEMP-H</b> □ (Temperature input high limit action) is selected in [EVT4 type] • Not available for P control. • Setting range: 0 to 10000 seconds	0 sec.
E4CS□ -----	<b>EVT4 pH input error alarm EVT□ type</b> • Selects an EVT□ type (except EVT4 type) in order to assess EVT4 pH input error alarm. • Available only when <b>EPUL</b> □□ (pH input error alarm output) is selected in [EVT4 type] • Selection item <b>EVT1</b> □□ : EVT1 type <b>EVT2</b> □□ : EVT2 type <b>EVT3</b> □□ : EVT3 type ----- : No action	No action
E4P0□ □□□□0.0	<b>EVT4 pH input error alarm span when EVT□ output ON</b> • Sets span to assess EVT4 pH input error alarm when EVT□ output is ON – which is selected in [EVT4 pH input error alarm EVT□ type]. • Available only when <b>EPUL</b> □□ (pH input error alarm output) is selected in [EVT4 type] • Setting range: pH 0.0 to 14.0 When set to 0.0, pH input error alarm is disabled.	pH 0.0
E4P0T □□□□□0	<b>EVT4 pH input error alarm time when EVT□ output ON</b> • Sets time to assess EVT4 pH input error alarm when EVT□ output is ON – which is selected in [EVT4 pH input error alarm EVT□ type]. • Available only when <b>EPUL</b> □□ (pH input error alarm output) is selected in [EVT4 type] • Setting range: 0 to 10000 seconds or minutes (Time unit follows the selection in [pH/ORP input error alarm time unit].) When set to 0, pH input error alarm is disabled.	0 sec.
E4PC□ □□□□0.0	<b>EVT4 pH input error alarm span when EVT□ output OFF</b> • Sets span to assess EVT4 pH input error alarm when EVT□ output is OFF – which is selected in [EVT4 pH input error alarm EVT□ type]. • Available only when <b>EPUL</b> □□ (pH input error alarm output) is selected in [EVT4 type] • Setting range: pH 0.0 to 14.0 When set to 0.0, pH input error alarm is disabled.	pH 0.0

Character	Setting Item, Function, Setting Range	Factory Default
<b>E4PCT</b> □□□□□ <b>0</b>	<b>EVT4 pH input error alarm time when EVT□ output OFF</b> <ul style="list-style-type: none"> <li>• Sets time to assess EVT4 pH input error alarm when EVT□ output is OFF – which is selected in [EVT4 pH input error alarm EVT□ type].</li> <li>• Available only when <b>EPUL</b>□□ (pH input error alarm output) is selected in [EVT4 type]</li> <li>• Setting range: 0 to 10000 seconds or minutes (Time unit follows the selection in [pH/ORP input error alarm time unit].) When set to 0, pH input error alarm is disabled.</li> </ul>	0 sec.
<b>MVZN4</b> □□□ <b>50.0</b>	<b>EVT4 cycle variable range</b> <ul style="list-style-type: none"> <li>• Sets EVT4 cycle range to be changed.</li> <li>• Available when <b>PH-L</b>□□ (pH input low limit action), <b>PH-H</b>□□ (pH input high limit action), <b>TEMPL</b>□ (Temperature input low limit action) or <b>TEMPH</b>□ (Temperature input high limit action) is selected in [EVT4 type]</li> <li>• Not available for ON/OFF control.</li> <li>• Setting range: 1.0 to 100.0%</li> </ul>	50.0%
<b>CENT4</b> □□□□□ <b>0</b>	<b>EVT4 cycle extended time</b> <ul style="list-style-type: none"> <li>• Sets time to extend EVT4 cycle.</li> <li>• Available when <b>PH-L</b>□□ (pH input low limit action), <b>PH-H</b>□□ (pH input high limit action), <b>TEMPL</b>□ (Temperature input low limit action) or <b>TEMPH</b>□ (Temperature input high limit action) is selected in [EVT4 type]</li> <li>• Not available for ON/OFF control.</li> <li>• Setting range: 0 to 300 seconds</li> </ul>	0 sec.

### 6.9.2 When Selecting ORP Meter

To enter EVT4 Group, follow the procedure below.

- ① **G\_ORP** Press the  **MODE** key in pH-Temperature/ORP Display Mode, or Cleansing Output Mode.
- ② **G\_E04** Press the  **▽** key as many times as necessary until the left characters appear.
- ③ **EVT4F** Press the  **SET** key.

The unit will enter EVT4 Group, and 'EVT4 type' will appear.

Character	Setting Item, Function, Setting Range	Factory Default
<b>EVT4F</b> -----	<b>EVT4 type</b> <ul style="list-style-type: none"> <li>• Selects an EVT4 output (Contact output 4) type. (Fig. 6.9-1)(p.57)</li> <li><b>Note: If EVT4 type is changed, EVT4 value will default to 0.</b></li> <li>• ----- : No action</li> <li>• <b>ORP-L</b>□ : ORP input low limit action</li> <li>• <b>ORP-H</b>□ : ORP input high limit action</li> <li>• <b>CLEG</b>□□ : Cleansing output</li> <li>• <b>EOUL</b>□□ : ORP input error alarm output</li> </ul>	No action
<b>ESV4</b> □ □□□□□ <b>0</b>	<b>EVT4 value</b> <ul style="list-style-type: none"> <li>• Selects an EVT4 value.</li> <li>• Available when <b>ORP-L</b>□ (ORP input low limit action) or <b>ORP-H</b>□ (ORP input high limit action) is selected in [EVT4 type].</li> <li>• Setting range: Input low limit to Input high limit</li> </ul>	0 mV
<b>EP4</b> □□ □□□□□ <b>0</b>	<b>EVT4 proportional band</b> <ul style="list-style-type: none"> <li>• Sets EVT4 proportional band.</li> <li>• ON/OFF control when set to 0.</li> <li>• Available when <b>ORP-L</b>□ (ORP input low limit action) or <b>ORP-H</b>□ (ORP input high limit action) is selected in [EVT4 type].</li> <li>• Setting range: 0 to Input span</li> </ul>	0 mV

Character	Setting Item, Function, Setting Range	Factory Default
E4RST □□□□0	<b>EVT4 reset</b> <ul style="list-style-type: none"> <li>• Sets the EVT4 reset value.</li> <li>• Available when <b>ORP-L</b> (ORP input low limit action) or <b>ORP-H</b> (ORP input high limit action) is selected in [EVT4 type].</li> <li>• Not available for ON/OFF control.</li> <li>• Setting range: <math>\pm 200</math> mV</li> </ul>	0 mV
E4DIF SDIF□□	<b>EVT4 hysteresis type</b> <ul style="list-style-type: none"> <li>• Selects EVT4 output hysteresis type (Medium or Reference Value). (Fig. 6.9-1)(p.57)</li> <li>• Available when <b>ORP-L</b> (ORP input low limit action) or <b>ORP-H</b> (ORP input high limit action) is selected in [EVT4 type].</li> <li>• Not available for P control.</li> <li>• <b>CDIF</b>□□: Medium Value  Sets the same value for both ON and OFF sides in relation to EVT4 value.  Only ON side needs to be set.</li> <li>• <b>SDIF</b>□□: Reference Value  Sets individual values for ON and OFF sides in relation to EVT4 value.  Both ON and OFF sides need to be set individually.</li> </ul>	Reference Value
E4DF0 □□□□10	<b>EVT4 ON side</b> <ul style="list-style-type: none"> <li>• Sets the span of EVT4 ON side. (Fig. 6.9-1)(p.57)</li> <li>• If <b>CDIF</b>□□ (Medium Value) is selected in [EVT4 hysteresis type], the span of ON/OFF side will be the same value.</li> <li>• Available when <b>ORP-L</b> (ORP input low limit action) or <b>ORP-H</b> (ORP input high limit action) is selected in [EVT4 type].</li> <li>• Not available for P control.</li> <li>• Setting range: 0 to 200 mV</li> </ul>	10 mV
E4DFU □□□□10	<b>EVT4 OFF side</b> <ul style="list-style-type: none"> <li>• Sets the span of EVT4 OFF side. (Fig. 6.9-1)(p.57)</li> <li>• Available when <b>ORP-L</b> (ORP input low limit action) or <b>ORP-H</b> (ORP input high limit action) is selected in [EVT4 type].</li> <li>• Available when <b>SDIF</b>□□ (Reference Value) is selected in [EVT4 hysteresis type].</li> <li>• Not available for P control.</li> <li>• Setting range: 0 to 200 mV</li> </ul>	10 mV
E40NT □□□□0	<b>EVT4 ON delay time</b> <ul style="list-style-type: none"> <li>• Sets EVT4 ON delay time.</li> <li>• The EVT4 output does not turn ON (under the conditions of turning ON) until the time set in [EVT4 ON delay time] elapses.</li> <li>• Available when <b>ORP-L</b> (ORP input low limit action) or <b>ORP-H</b> (ORP input high limit action) is selected in [EVT4 type].</li> <li>• Not available for P control.</li> <li>• Setting range: 0 to 10000 seconds</li> </ul>	0 sec.
E40FT □□□□0	<b>EVT4 OFF delay time</b> <ul style="list-style-type: none"> <li>• Sets EVT4 OFF delay time.</li> <li>• The EVT4 output does not turn OFF (under the conditions of turning OFF) until the time set in [EVT4 OFF delay time] elapses.</li> <li>• Available when <b>ORP-L</b> (ORP input low limit action) or <b>ORP-H</b> (ORP input high limit action) is selected in [EVT4 type].</li> <li>• Not available for P control.</li> <li>• Setting range: 0 to 10000 seconds</li> </ul>	0 sec.

Character	Setting Item, Function, Setting Range	Factory Default
E4C□□ □□□□30	<b>EVT4 proportional cycle</b> <ul style="list-style-type: none"> <li>• Sets proportional cycle for EVT4.</li> <li>• Available when <b>ORP-L</b>□ (ORP input low limit action) or <b>ORP-H</b>□ (ORP input high limit action) is selected in [EVT4 type].</li> <li>• Not available for ON/OFF control.</li> <li>• Setting range: 1 to 300 seconds</li> </ul>	30 sec.
E40LH □□□100	<b>EVT4 output high limit</b> <ul style="list-style-type: none"> <li>• Sets EVT4 output high limit value.</li> <li>• Available when <b>ORP-L</b>□ (ORP input low limit action) or <b>ORP-H</b>□ (ORP input high limit action) is selected in [EVT4 type].</li> <li>• Not available for ON/OFF control.</li> <li>• Setting range: EVT4 output low limit value to 100%</li> </ul>	100%
E40LL □□□□0	<b>EVT4 output low limit</b> <ul style="list-style-type: none"> <li>• Sets EVT4 output low limit value.</li> <li>• Available when <b>ORP-L</b>□ (ORP input low limit action) or <b>ORP-H</b>□ (ORP input high limit action) is selected in [EVT4 type].</li> <li>• Not available for ON/OFF control.</li> <li>• Setting range: 0% to EVT4 output high limit value</li> </ul>	0%
OONT4 □□□□0	<b>Output ON time when EVT4 output ON</b> <ul style="list-style-type: none"> <li>• Sets Output ON time when EVT4 output is ON.</li> <li>• If ON time and OFF time are set, EVT4 output can be turned ON/OFF in a configured cycle when EVT4 output is ON. (Fig. 6.9-2)(p.57)</li> <li>• Available when <b>ORP-L</b>□ (ORP input low limit action) or <b>ORP-H</b>□ (ORP input high limit action) is selected in [EVT4 type].</li> <li>• Not available for P control.</li> <li>• Setting range: 0 to 10000 seconds</li> </ul>	0 sec.
OOF4 □□□□0	<b>Output OFF time when EVT4 output ON</b> <ul style="list-style-type: none"> <li>• Sets Output OFF time when EVT4 output is ON.</li> <li>• If ON time and OFF time are set, EVT4 output can be turned ON/OFF in a configured cycle when EVT4 output is ON. (Fig. 6.9-2)(p.57)</li> <li>• Available when <b>ORP-L</b>□ (ORP input low limit action) or <b>ORP-H</b>□ (ORP input high limit action) is selected in [EVT4 type].</li> <li>• Not available for P control.</li> <li>• Setting range: 0 to 10000 seconds</li> </ul>	0 sec.
E4CS□ -----	<b>EVT4 ORP input error alarm EVT□ type</b> <ul style="list-style-type: none"> <li>• Selects an EVT□ type (except EVT4 type) in order to assess EVT4 ORP input error alarm.</li> <li>• Available only when <b>EOUL</b>□□ (ORP input error alarm output) is selected in [EVT4 type]</li> <li>• Selection item  <b>EVT1</b>□□ : EVT1 type  <b>EVT2</b>□□ : EVT2 type  <b>EVT3</b>□□ : EVT3 type  ----- : No action </li> </ul>	No action
E400□ □□□□0	<b>EVT4 ORP input error alarm span when EVT□ output ON</b> <ul style="list-style-type: none"> <li>• Sets span to assess EVT4 ORP input error alarm when EVT□ output is ON – which is selected in [EVT4 ORP input error alarm EVT□ type].</li> <li>• Available only when <b>EOUL</b>□□ (ORP input error alarm output) is selected in [EVT4 type]</li> <li>• Setting range: 0 to 2000 mV When set to 0, ORP input error alarm is disabled.</li> </ul>	0 mV



Character	Setting Item, Function, Setting Range	Factory Default
<b>E400T</b> □□□□□ 0	<b>EVT4 ORP input error alarm time when EVT□ output ON</b> <ul style="list-style-type: none"> <li>• Sets time to assess EVT4 ORP input error alarm when EVT□ output is ON – which is selected in [EVT4 ORP input error alarm EVT□ type].</li> <li>• Available only when <b>E0UL</b>□□ (ORP input error alarm output) is selected in [EVT4 type]</li> <li>• Setting range: 0 to 10000 seconds or minutes (Time unit follows the selection in [pH/ORP input error alarm time unit].) When set to 0, ORP input error alarm is disabled.</li> </ul>	0 sec.
<b>E40C</b> □ □□□□□ 0	<b>EVT4 ORP input error alarm span when EVT□ output OFF</b> <ul style="list-style-type: none"> <li>• Sets span to assess EVT4 ORP input error alarm when EVT□ output is OFF – which is selected in [EVT4 ORP input error alarm EVT□ type].</li> <li>• Available only when <b>E0UL</b>□□ (ORP input error alarm output) is selected in [EVT4 type]</li> <li>• Setting range: 0 to 2000 mV When set to 0, ORP input error alarm is disabled.</li> </ul>	0 mV
<b>E40CT</b> □□□□□ 0	<b>EVT4 ORP input error alarm time when EVT□ output OFF</b> <ul style="list-style-type: none"> <li>• Sets time to assess EVT4 ORP input error alarm when EVT□ output is OFF – which is selected in [EVT4 ORP input error alarm EVT□ type].</li> <li>• Available only when <b>E0UL</b>□□ (ORP input error alarm output) is selected in [EVT4 type]</li> <li>• Setting range: 0 to 10000 seconds or minutes (Time unit follows the selection in [pH/ORP input error alarm time unit].) When set to 0, ORP input error alarm is disabled.</li> </ul>	0 sec.
<b>MVZN4</b> □□ 50.0	<b>EVT4 cycle variable range</b> <ul style="list-style-type: none"> <li>• Sets EVT4 cycle range to be changed.</li> <li>• Available when <b>ORP-L</b>□ (ORP input low limit action) or <b>ORP-H</b>□ (ORP input high limit action) is selected in [EVT4 type].</li> <li>• Not available for ON/OFF control.</li> <li>• Setting range: 1.0 to 100.0%</li> </ul>	50.0%
<b>CENT4</b> □□□□□ 0	<b>EVT4 cycle extended time</b> <ul style="list-style-type: none"> <li>• Sets time to extend EVT4 cycle.</li> <li>• Available when <b>ORP-L</b>□ (ORP input low limit action) or <b>ORP-H</b>□ (ORP input high limit action) is selected in [EVT4 type].</li> <li>• Not available for ON/OFF control.</li> <li>• Setting range: 0 to 300 seconds</li> </ul>	0 sec.

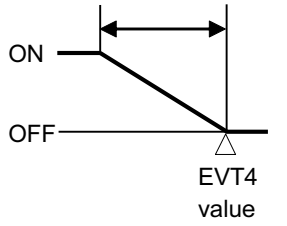
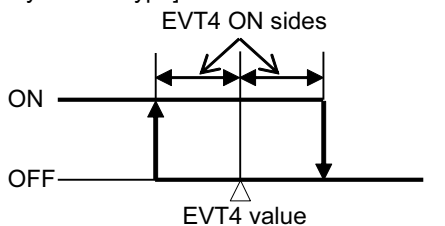
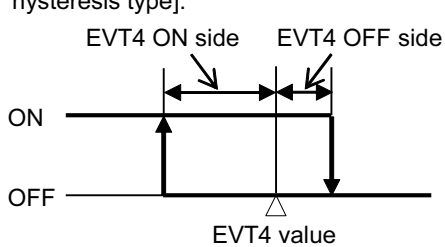
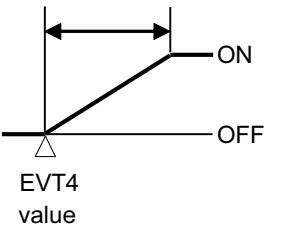
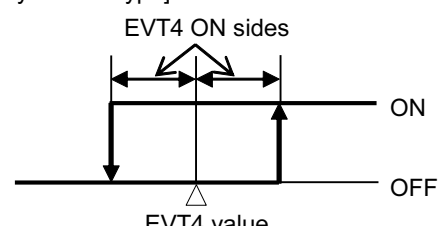
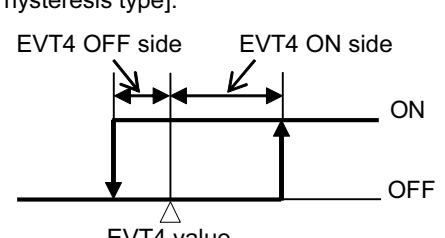

### EVT4 Action

EVT4 Type	P Control Action	ON/OFF Control Action
pH input low limit action, Temperature input low limit action, ORP input low limit action	EVT4 proportional band 	If Medium Value is selected in [EVT4 hysteresis type]: 
		If Reference Value is selected in [EVT4 hysteresis type]: 
pH input high limit action, Temperature input high limit action, ORP input high limit action	EVT4 proportional band 	If Medium Value is selected in [EVT4 hysteresis type]: 
		If Reference Value is selected in [EVT4 hysteresis type]: 

(Fig. 6.9-1)

### Timing chart of EVT4 output ON time and OFF time while in EVT4 output ON

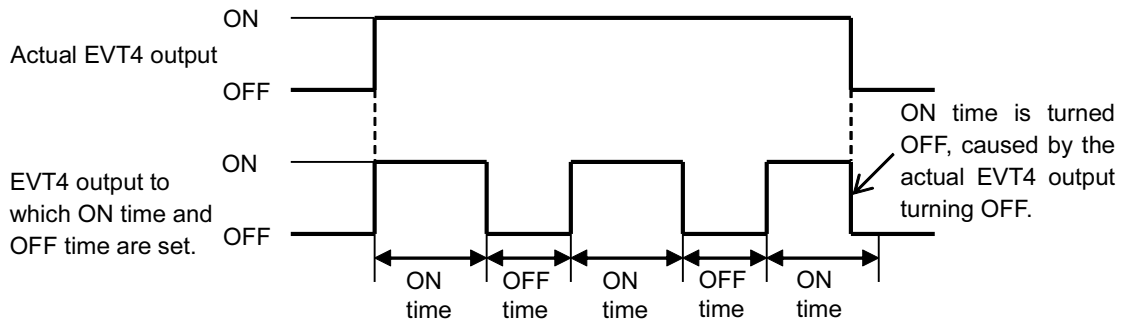

(Fig. 6.9-2)

## 6.10 Communication Group

Available only when C5 option is ordered.

To enter the Communication Group, follow the procedure below.

- ① **G\_PH** Press the  MODE key in pH-Temperature/ORP Display Mode, or Cleansing Output Mode.
- ② **G\_COM** Press the  key as many times as necessary until the left characters appear.
- ③ **CMSL** Press the  SET key.

The unit will enter the Communication Group, and the 'Communication protocol' will appear.

Character	Setting Item, Function, Setting Range	Factory Default
<b>CMSL</b> <b>NOML</b>	<b>Communication protocol</b> <ul style="list-style-type: none"> <li>• Selects communication protocol.</li> <li>• <b>NOML</b> : Shinko protocol</li> <li>• <b>MODA</b> : Modbus ASCII mode</li> <li>• <b>MODR</b> : Modbus RTU mode</li> </ul>	Shinko protocol
<b>CMNO</b> <b>00000</b>	<b>Instrument number</b> <ul style="list-style-type: none"> <li>• Sets the instrument number. (The instrument numbers should be set one by one when multiple instruments are connected.)</li> <li>• Setting range: 0 to 95</li> </ul>	0
<b>CMSP</b> <b>9600</b>	<b>Communication speed</b> <ul style="list-style-type: none"> <li>• Selects a communication speed equal to that of the host computer.</li> <li>• <b>9600</b> : 9600 bps</li> <li>• <b>19200</b> : 19200 bps</li> <li>• <b>38400</b> : 38400 bps</li> </ul>	9600 bps
<b>CMFT</b> <b>7EVN</b>	<b>Data bit/Parity</b> <ul style="list-style-type: none"> <li>• Selects data bit and parity.</li> <li>• <b>8NON</b> : 8 bits/No parity</li> <li>• <b>7NON</b> : 7 bits/No parity</li> <li>• <b>8EVN</b> : 8 bits/Even</li> <li>• <b>7EVN</b> : 7 bits/Even</li> <li>• <b>8ODD</b> : 8 bits/Odd</li> <li>• <b>7ODD</b> : 7 bits/Odd</li> </ul>	7 bits/Even
<b>CMST</b> <b>00001</b>	<b>Stop bit</b> <ul style="list-style-type: none"> <li>• Selects the stop bit.</li> <li>• <b>1</b> : 1 bit</li> <li>• <b>2</b> : 2 bits</li> </ul>	1 bit

## 6.11 Transmission Output Group

Depending on the selection in Section 6.2 Model Selection (p.18), setting items are different as follows.

### 6.11.1 When Selecting pH Meter

To enter the Transmission Output Group, follow the procedure below.

- ① **G\_pH** Press the **MODE** key in pH-Temperature/ORP Display Mode, or Cleansing Output Mode.
- ② **G\_TRA** Press the **▽** key as many times as necessary until the left characters appear.
- ③ **TROS1** Press the **SET** key.

The unit will enter Transmission Output Group, and 'Transmission output 1 type' will appear.

Character	Setting Item, Function, Setting Range	Factory Default
<b>TROS1</b> pH□□□□	<b>Transmission output 1 type</b> <ul style="list-style-type: none"> <li>• Selects the transmission output 1 type.</li> <li>If <b>NONE</b>□□ (No temperature compensation) is selected in [Electrode RTD (p.21)], and if <b>TEMP</b>□□ (Temperature transmission) is selected here, the value set in [Reference temperature (p.21)] will be output regardless of the selection in [Display when no temperature compensation (p.64)].</li> <li>• <b>pH</b>□□□□ : pH transmission</li> <li>• <b>TEMP</b>□□ : Temperature transmission</li> <li>• <b>MV1</b>□□□□ : EVT1 MV transmission</li> <li>• <b>MV2</b>□□□□ : EVT2 MV transmission</li> </ul>	pH transmission
<b>TRLH1</b> □□14.00	<b>Transmission output 1 high limit</b> <ul style="list-style-type: none"> <li>• Sets the Transmission output 1 high limit value. (This value corresponds to 20 mA DC output.)</li> <li>If Transmission output 1 high limit and low limit are set to the same value, Transmission output 1 will be fixed at 4 mA DC.</li> <li>• pH transmission: Transmission output 1 low limit to pH 14.00 (*)</li> <li>• Temperature transmission: Transmission output 1 low limit to 100.0°C (*)</li> <li>• MV transmission: Transmission output 1 low limit to 100.0%</li> </ul>	pH transmission: pH 14.00 Temperature transmission: 100.0°C MV transmission: 100.0%
<b>TRLL1</b> □□□0.00	<b>Transmission output 1 low limit</b> <ul style="list-style-type: none"> <li>• Sets the Transmission output 1 low limit value. (This value corresponds to 4 mA DC output.)</li> <li>If Transmission output 1 high limit and low limit are set to the same value, Transmission output 1 will be fixed at 4 mA DC.</li> <li>• pH transmission: pH 0.00 to Transmission output 1 high limit (*)</li> <li>• Temperature transmission: 0.0°C to Transmission output 1 high limit (*)</li> <li>• MV transmission: 0.0% to Transmission output 1 high limit</li> </ul>	pH transmission: pH 0.00 Temperature transmission: 0.0°C MV transmission: 0.0%
<b>TRCS1</b> BEFH□□	<b>Transmission output 1 status when calibrating</b> <ul style="list-style-type: none"> <li>• Sets the Transmission output 1 status when calibrating pH.</li> <li>• <b>BEFH</b>□□ : Last value HOLD (Retains and outputs the last value before pH calibration.)</li> <li>• <b>SETH</b>□□ : Set value HOLD (Outputs the value set in [Transmission output 1 Set value HOLD].)</li> <li>• <b>PVH</b>□□□ : Measured value (Outputs the measured value when calibrating pH.)</li> </ul>	Last value HOLD
<b>TRSE1</b> □□□0.00	<b>Transmission output 1 Set value HOLD</b> <ul style="list-style-type: none"> <li>• Sets the Transmission output 1 Set value HOLD</li> <li>Available only when <b>SETH</b>□□ (Set value HOLD) is selected in [Transmission output 1 status when calibrating]</li> <li>• pH transmission: pH 0.00 to 14.00 (*)</li> <li>• Temperature transmission: 0.0 to 100.0°C (*)</li> <li>• MV transmission: 0.0 to 100.0%</li> </ul>	pH transmission: pH 0.00 Temperature transmission: 0.0°C MV transmission: 0.0%

(\*) The placement of the decimal point does not follow the selection. It is fixed.

Character	Setting Item, Function, Setting Range	Factory Default
<b>TR0S2</b> <b>pH</b> [ ][ ][ ][ ]	<b>Transmission output 2 type</b> <ul style="list-style-type: none"> <li>• Selects the transmission output 2 type.            If <b>NONE</b> [ ][ ] (No temperature compensation) is selected in [Electrode RTD (p.21)], and if <b>TEMP</b> [ ][ ] (Temperature transmission) is selected here, the value set in [Reference temperature (p.21)] will be output regardless of the selection in [Display when no temperature compensation (p.64)].</li> <li>• <b>pH</b> [ ][ ][ ] : pH transmission</li> <li>• <b>TEMP</b> [ ][ ] : Temperature transmission</li> <li>• <b>MV1</b> [ ][ ][ ] : EVT1 MV transmission</li> <li>• <b>MV2</b> [ ][ ][ ] : EVT2 MV transmission</li> <li>• <b>MV3</b> [ ][ ][ ] : EVT3 MV transmission</li> </ul>	pH transmission
<b>TRLH2</b> [ ][ ] <b>14.00</b>	<b>Transmission output 2 high limit</b> <ul style="list-style-type: none"> <li>• Sets the Transmission output 2 high limit value. (This value corresponds to 20 mA DC output.)            If Transmission output 2 high limit and low limit are set to the same value, Transmission output 2 will be fixed at 4 mA DC.</li> <li>• pH transmission: Transmission output 2 low limit to 14.00 pH (*)            Temperature transmission: Transmission output 2 low limit to 100.0°C (*)            MV transmission: Transmission output 2 low limit to 100.0%</li> </ul>	pH transmission: pH 14.00 Temperature transmission: 100.0°C MV transmission: 100.0%
<b>TRLL2</b> [ ][ ][ ] <b>0.00</b>	<b>Transmission output 2 low limit</b> <ul style="list-style-type: none"> <li>• Sets the Transmission output 2 low limit value. (This value corresponds to 4 mA DC output.)            If Transmission output 2 high limit and low limit are set to the same value, Transmission output 2 will be fixed at 4 mA DC.</li> <li>• pH transmission: pH 0.00 to Transmission output 2 high limit (*)            Temperature transmission: 0.0°C to Transmission output 2 high limit (*)            MV transmission: 0.0% to Transmission output 2 high limit</li> </ul>	pH transmission: pH 0.00 Temperature transmission: 0.0°C MV transmission: 0.0%
<b>TRCS2</b> <b>BEFH</b> [ ][ ]	<b>Transmission output 2 status when calibrating</b> <ul style="list-style-type: none"> <li>• Sets the Transmission output 2 status when calibrating pH.</li> <li>• <b>BEFH</b> [ ][ ] : Last value HOLD (Retains and outputs the last value before pH calibration.)</li> <li>• <b>SETH</b> [ ][ ] : Set value HOLD (Outputs the value set in [Transmission output 2 Set value HOLD].)</li> <li>• <b>PVH</b> [ ][ ][ ] : Measured value (Outputs the measured value when calibrating pH.)</li> </ul>	Last value HOLD
<b>TRSE2</b> [ ][ ] <b>14.00</b>	<b>Transmission output 2 Set value HOLD</b> <ul style="list-style-type: none"> <li>• Sets the Transmission output 2 Set value HOLD.            Available only when <b>SETH</b> [ ][ ] (Set value HOLD) is selected in [Transmission output 2 status when calibrating]</li> <li>• pH transmission: pH 0.00 to 14.00 (*)            Temperature transmission: 0.0 to 100.0°C (*)            MV transmission: 0.0 to 100.0%</li> </ul>	pH transmission: pH 0.00 Temperature transmission: 0.0°C MV transmission: 0.0%

(\*) The placement of the decimal point does not follow the selection. It is fixed.

### 6.11.2 When Selecting ORP Meter

To enter the Transmission Output Group, follow the procedure below.

- ① **G\_ORP** Press the MODE key in pH-Temperature/ORP Display Mode, or Cleansing Output Mode.
- ② **G\_TRA** Press the ▽ key as many times as necessary until the left characters appear.
- ③ **TROS1** Press the SET key.

The unit will enter Transmission Output Group, and 'Transmission output 1 type' will appear.

Character	Setting Item, Function, Setting Range	Factory Default
<b>TROS1</b> ORP□□□	<b>Transmission output 1 type</b> • Selects Transmission output 1 type. <b>ORP</b> □□□ : ORP transmission <b>MV1</b> □□□ : EVT1 MV transmission <b>MV2</b> □□□ : EVT2 MV transmission	ORP transmission
<b>TRLH1</b> □□2000	<b>Transmission output 1 high limit</b> • Sets the Transmission output 1 high limit value. (This value corresponds to 20 mA DC output.) If Transmission output 1 high limit and low limit are set to the same value, Transmission output 1 will be fixed at 4 mA DC. • Setting range ORP transmission: Transmission output 1 low limit to 2000 mV MV transmission: Transmission output 1 low limit to 100.0%	ORP transmission : 2000 mV MV transmission : 100.0%
<b>TRLL1</b> □□-2000	<b>Transmission output 1 low limit</b> • Sets the Transmission output 1 low limit value. (This value corresponds to 4 mA DC output.) If Transmission output 1 high limit and low limit are set to the same value, Transmission output 1 will be fixed at 4 mA DC. • Setting range: ORP transmission: -2000 mV to Transmission output 1 high limit MV transmission: 0.0% to Transmission output 1 high limit	ORP transmission : -2000 mV MV transmission : 0.0%
<b>TRCS1</b> BEFH□□	<b>Transmission output 1 status in Adjustment Mode, Span Sensitivity Correction Mode</b> • Selects the Transmission output 1 status in Adjustment Mode or Span Sensitivity Correction Mode. • <b>BEFH</b> □□: Last value HOLD (Retains and outputs the last value before performing Adjustment Mode or Span Sensitivity Correction Mode.) <b>SETH</b> □□: Set value HOLD (Outputs the value set in [Transmission output 1 Set value HOLD].) <b>PVH</b> □□□: Measured value (Outputs the measured value in Adjustment Mode or Span Sensitivity Correction Mode)	Last value HOLD
<b>TRSE1</b> □□□□0	<b>Transmission output 1 Set value HOLD</b> • Sets the Transmission output 1 Set value HOLD. Available only when <b>SETH</b> □□ (Set value HOLD) is selected in [Transmission output 1 status in Adjustment Mode, Span Sensitivity Correction Mode] • ORP transmission: -2000 to 2000 mV MV transmission: 0.0 to 100.0%	ORP transmission : 0 mV MV transmission : 0.0%
<b>TROS2</b> ORP□□□	<b>Transmission output 2 type</b> • Selects the Transmission output 2 type. • <b>ORP</b> □□□ : ORP transmission <b>MV1</b> □□□ : EVT1 MV transmission <b>MV2</b> □□□ : EVT2 MV transmission <b>MV3</b> □□□ : EVT3 MV transmission	ORP transmission

Character	Setting Item, Function, Setting Range	Factory Default
TRLH2 □□2000	<b>Transmission output 2 high limit</b> • Sets the Transmission output 2 high limit value. (This value corresponds to 20 mA DC output.) If Transmission output 2 high limit and low limit are set to the same value, Transmission output 2 will be fixed at 4 mA DC. • Setting range ORP transmission: Transmission output 2 low limit to 2000 mV MV transmission: Transmission output 2 low limit to 100.0%	ORP transmission : 2000 mV MV transmission : 100.0%
TRLL2 □□-2000	<b>Transmission output 2 low limit</b> • Sets the Transmission output 2 low limit value. (This value corresponds to 4 mA DC output.) If Transmission output 2 high limit and low limit are set to the same value, Transmission output 2 will be fixed at 4 mA DC. • Setting range: ORP transmission: -2000 mV to Transmission output 2 high limit MV transmission: 0.0% to Transmission output 2 high limit	ORP transmission : -2000 mV MV transmission : 0.0%
TRCS2 BEFH□□	<b>Transmission output 2 status in Adjustment Mode, Span Sensitivity Correction Mode</b> • Selects the Transmission output 2 status in Adjustment Mode or Span Sensitivity Correction Mode. • <b>BEFH</b> □□ : Last value HOLD (Retains and outputs the last value before performing Adjustment Mode or Span Sensitivity Correction Mode.) <b>SETH</b> □□ : Set value HOLD (Outputs the value set in [Transmission output 2 Set value HOLD].) <b>PVH</b> □□□ : Measured value (Outputs the measured value in Adjustment Mode or Span Sensitivity Correction Mode.)	Last value HOLD
TRSE2 □□□□0	<b>Transmission output 2 Set value HOLD</b> • Sets the Transmission output 2 Set value HOLD. Available only when <b>SETH</b> □□ (Set value HOLD) is selected in [Transmission output 2 status in Adjustment Mode or Span Sensitivity Correction Mode] • ORP transmission: -2000 to 2000 mV MV transmission: 0.0 to 100.0%	ORP transmission: 0 mV MV transmission: 0.0%

## 6.12 Cleansing Function Group

To enter the Cleansing Function Group, follow the procedure below.

- ① **G\_PH**□□ Press the **MODE** key in pH-Temperature/ORP Display Mode, or Cleansing Output Mode.
- ② **G\_CLN** Press the **▽** key as many times as necessary until the left characters appear.
- ③ **CCNT**□□ Press the **SET** key.

The unit will enter the Cleansing Function Group, and 'Number of cleansing cycles' will appear.

Character	Setting Item, Function, Setting Range	Factory Default
CCNT□□ □□□□0	<b>Number of cleansing cycles</b> • Sets the number of cleansing outputs. (Fig. 6.12-1) (p.63) • Setting range: 0 to 10 times (0: Continuous cleansing)	0 (Continuous cleansing)
CCYC□□ □□360	<b>Cleansing interval</b> • Sets an interval between cleansing outputs. (Fig. 6.12-1) (p.63) • Setting range: 60 to 3000 minutes	360 minutes
CTIM□□ □□600	<b>Cleansing time</b> • Sets the cleansing output time during the cleansing output interval. (Fig. 6.12-1) (p.63) • Setting range: 1 to 1800 seconds	600 sec.
CREC□□ □□600	<b>Restore time after cleansing</b> • Sets the time to restore units to normal operation after cleansing output. (Fig. 6.12-1) • Setting range: 1 to 1800 seconds	600 sec.

• **Cleansing Output Action**

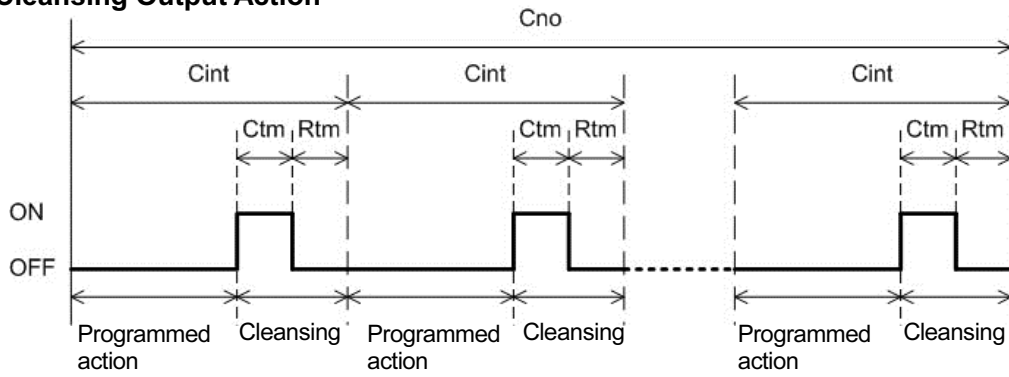

Cno: Number of cleansing cycles  
 Cint: Cleansing interval  
 Ctm: Cleansing time  
 Rtm: Restore time after cleansing

(Fig. 6.12-1)

**6.13 Special Function Group**

To enter the Special Function Group, follow the procedure below.

- ① **G\_PH** Press the  key in pH-Temperature/ORP Display Mode, or Cleansing Output Mode.
- ② **G\_OTH** Press the  key as many times as necessary until the left characters appear.
- ③ **LOCK** Press the  key.

The unit will enter the Special Function Group, and the 'Set value lock' will appear.

Character	Setting Item, Function, Setting Range	Factory Default
<b>LOCK</b> -----	<b>Set value lock</b> • Locks the set values to prevent setting errors. • ----- (Unlock): All set values can be changed. <b>LOCK1</b> (Lock 1): None of the set values can be changed. <b>LOCK2</b> (Lock 2): Only EVT1, EVT2, EVT3, EVT4 values can be changed. <b>LOCK3</b> (Lock 3): All set values – except Electrode RTD, Temperature calibration value, pH calibration value, pH calibration Auto/Manual, Adjustment value, Span sensitivity correction value, Transmission output 1 Zero adjustment value, Transmission output 1 Span adjustment value, Transmission output 2 Zero adjustment value, Transmission output 2 Span adjustment value – can be temporarily changed. However, they revert to their previous value after the power is turned off because they are not saved in the non-volatile IC memory. Do not change setting items (EVT1, EVT2, EVT3, EVT4 types). If they are changed, they will affect other setting items. Be sure to select Lock 3 when changing the set value frequently via software communication. (If a value set via software communication is the same as the value before the setting, the value will not be written in non-volatile IC memory.)	Unlock
<b>DISP</b> <b>DUAL</b>	<b>Display selection (for pH meter)</b> • Selects items to be indicated in the pH/ORP Display and Temperature/Set Value Display. Available when <b>ORP</b> (ORP meter) is selected in Section 6.2 Model Selection (p.18). • <b>DUAL</b> : Input value (pH, Temperature) <b>PH</b> : pH <b>TEMP</b> : Temperature	Input value (pH, Temperature)

Character	Setting Item, Function, Setting Range	Factory Default
DISP -----	<b>Display selection (for ORP meter)</b> • Selects an item to be indicated in the Temperature/Set Value Display. Available when <b>ORP</b> (ORP meter) is selected in Section 6.2 Model Selection (p.18). • ----- : No indication <b>ESV1</b> : EVT1 value <b>ESV2</b> : EVT2 value	No indication
INERR OFF	<b>EVT output when input errors occur</b> • If input errors occur, such as pH Combined Electrode Sensor is disconnected or short-circuited, EVT output can be Enabled or Disabled. If “Enabled” is selected, EVT output will be maintained when input errors occur. If “Disabled” is selected, EVT output will be turned OFF when input errors occur. • <b>ON</b> : Enabled <b>OFF</b> : Disabled	Disabled
OFDP OFF	<b>Display when no temperature compensation</b> • Selects an item to be indicated in the Temperature/Set value Display when <b>NONE</b> (No temperature compensation) is selected in [Electrode RTD (p.21)]. • Available when <b>pH</b> (pH meter) is selected in Section 6.2 Model Selection (p.18). Available when <b>NONE</b> (No temperature compensation) is selected in [Electrode RTD (p.21)]. • <b>STD</b> : Reference temperature <b>OFF</b> : Unlit	Unlit
M_S SEC	<b>pH/ORP input error alarm time unit</b> • Selects pH or ORP input error alarm time unit. • <b>SEC</b> : Second(s) <b>MIN</b> : Minute(s)	Second(s)
MODEL pH	<b>Model selection</b> • Selects a model. • <b>pH</b> : pH meter <b>ORP</b> : ORP meter	pH meter

#### 6.14 Zero/Slope Indication Group

Available when **pH** (pH meter) is selected in Section 6.2 Model Selection (p.18).

To enter the Zero/Slope Indication Group, follow the procedure below.

- ① **G\_PH** Press the **MODE** key in pH-Temperature/ORP Display Mode, or Cleansing Output Mode.
- ② **G\_ZS** Press the **▽** key as many times as necessary until the left characters appear.
- ③ **ZERO** Press the **SET** key.

The unit will enter the Zero/Slope Indication Group, and the ‘Zero indication’ will appear.

Character	Setting Item, Function, Setting Range	Factory Default
ZERO 0.0	<b>Zero indication</b> • Indicates electrical potential difference when calibrating pH 7. However, if manual calibration is performed, zero indication value calculated at previous automatic calculation will not be updated. If calibration is not successfully completed, zero indication value will show the value before calibration. • Indication range: Voltage equivalent to pH $\pm 1.5$	0.0 mV
SLOP 59.2	<b>Slope indication</b> • From the voltage calibrated at pH calibration, electromotive force for the change of pH 1 will be indicated. If calibration is not successfully completed, slope indication will show the value before calibration. • Indication range: Voltage equivalent to pH 0.00 to 14.00	59.2 mV



# 7. Calibration

The pH Calibration Mode, Temperature Calibration Mode, Adjustment Mode and Span Sensitivity Correction Mode are described below.

Depending on the selection in [6.2 Model Selection (p.18)], the unit enters the following mode. If pH meter is selected, the unit will enter pH Calibration Mode or Temperature Calibration Mode. If ORP meter is selected, the unit will enter Adjustment Mode or Span Sensitivity Correction Mode. Transmission output adjustment mode is common to pH meter and ORP meter.

## 7.1 pH Calibration Mode

For pH measurement using the glass electrode method, pH in the sensor location, electrode performance and standard solution accuracy respectively play an important role for obtaining reliable data.

There are 2 methods in pH calibration: Automatic Calibration and Manual Calibration.

If **AUTO** (Automatic) is selected in [pH Calibration Auto/Manual (p.19)], pH will be automatically calibrated.

If **MANU** (Manual) is selected in [pH Calibration Auto/Manual (p.19)], pH will be manually calibrated.

The unit cannot enter pH Calibration Mode in the following cases:

- if **LOCK1** (Lock 1), **LOCK2** (Lock 2) or **LOCK3** (Lock 3) is selected in [Set value lock (p.63)]
- If **CLEG** (Cleansing output) is selected in any of [EVT1, EVT2, EVT3, EVT4 type (pp. 22, 26, 31, 35, 40, 44, 49, 53)], and cleansing action is performing using the 'Cleansing time' and 'Restore time after cleansing' settings.

### 7.1.1 Automatic Calibration

The 1st point standard solution pH 7 (JIS or US standard) selected in [pH 7 calibration standard (p.19)] is automatically calibrated first, followed by calibration of the 2nd point solution [pH 2, pH 4, pH 9 or pH 10 (JIS)] selected in [2nd Solution (p.18)].

The pH value (based on JIS Z8802) at each temperature of pH standard solution will be automatically calculated.

If **NONE** (No temperature compensation) is selected in [Electrode RTD (p.21)], calibration will be automatically performed at 25°C basis.

The following shows the method for automatic calibration.

#### (1) The 1st Point Calibration

- ① Immerse the pH Combined Electrode Sensor in the 1st point standard solution (pH 7).  
When selecting **BEFH** (Last value HOLD) in [Transmission output 1 status when calibrating (p.59)] or in [Transmission output 2 status when calibrating (p.60)], select it while the sensor is being immersed in the solution currently calibrated.  
After that, immerse the sensor in the 1st point standard solution (pH 7).

- ② Press the **CAL** key in pH-Temperature/ORP Display Mode or Cleansing Output Mode.  
The unit will enter pH Calibration Mode, and will indicate the following.

Display	Indication
pH/ORP Display	Unlit
Temperature/Set value Display	<b>pH7</b>

- ③ Press the  key.

Automatic calibration of the 1st point starts.

During Automatic calibration, pH in the pH/ORP Display flashes.

Automatic calibration is carried out using the Automatic electrode quality evaluation function (\*).

When flashing stops, automatic calibration of the 1st point is complete.

(\*) The value calibrated by the Automatic electrode quality evaluation function will be as follows depending on the selection in [pH7 calibration standard (p.19)].

pH 7 Calibration Standard	Value Calibrated by the Automatic Electrode Quality Evaluation Function
JIS	pH 6.86
US standard	pH 7.00

## (2) The 2nd Point Calibration

- ① Confirm that automatic calibration of the 1st point is complete, then press the  key.

The 2nd standard solution will be shown in the display as follows.

Display	Indication
pH/ORP Display	Unlit
Temperature/Set Value Display	pH standard solution selected in [2nd Solution (p.18)] is indicated.

- ② Rinse the electrode, and immerse the pH Combined Electrode Sensor in the 2nd Standard solution.

- ③ Press the  key.

Automatic calibration of the 2nd point starts.



During Automatic calibration, pH in the pH/ORP Display flashes.

Automatic calibration is carried out using the Automatic electrode quality evaluation function.

When flashing stops, automatic calibration of the 2nd point is complete.

- ④ Confirm that automatic calibration of the 2nd point is complete, then press the  key.

The newly calibrated values will be applied to the unit, indicated as follows.

Display	Indication
pH/ORP Display	CAL 
Temperature/Setting Display	GOOD 

pH automatic calibration is now complete.

- ⑤ Press the  key.

The unit will revert to pH-Temperature/ORP Display Mode, or Cleansing Output Mode.

## 7.1.2 Manual Calibration

Manual calibration can be carried out using 2 types of solution with a difference of pH 2 or more.

The following shows the method for manual calibration.

### (1) The 1st Point Calibration

- ① Immerse the pH Combined Electrode Sensor in the 1st standard solution.

When selecting **BEFH**  (Last value HOLD) in [Transmission output 1 status when calibrating (p.59)] or in [Transmission output 2 status when calibrating (p.60)], select it while the sensor is being immersed in the solution currently calibrated.

After that, immerse the sensor in the 1st point standard solution.

- ② Press the **CAL** key in pH-Temperature/ORP Display Mode, or Cleansing Output Mode. The unit will enter pH Calibration Mode, indicating the following.

Display	Indication
pH/ORP Display	Unlit
Temperature/Set Value Display	□□-1-□

- ③ Press the **SET** key.

The unit will enter the 1st point manual calibration mode, indicating the following.

Display	Indication
pH/ORP Display	□-1-□ and pH are indicated alternately.
Temperature/Set Value Display	Calibration value

- ④ Set a calibration value with the **△** or **▽** key while checking the pH. pH calibration coefficient: -7.00 to 7.00

- ⑤ Press the **SET** key.

The 1st point calibration is completed, indicating the following.

Display	Indication
pH/ORP Display	Unlit
Temperature/Set Value Display	□□-2-□

## (2) The 2nd Point Calibration

- ① Rinse the electrode, and immerse the pH Combined Electrode Sensor in the 2nd Standard solution.

- ② Press the **SET** key.

The 2nd point can be calibrated manually, indicated as follows.

Display	Indication
pH/ORP Display	□□-2-□ and pH are indicated alternately.
Temperature/Set Value Display	Calibration value

- ③ Set a calibration value with the **△** or **▽** key while checking the pH. pH calibration coefficient: -7.00 to 7.00

- ④ Press the **SET** key.

The 2nd point calibration is completed. The newly calibrated values will be applied to the unit, indicated as follows.

Display	Indication
pH/ORP Display	CAL□□
Temperature/ Set Value Display	GOOD□□

- ⑤ Press the **MODE** key.

The unit will revert to pH-Temperature/ORP Display Mode, or Cleansing Output Mode.

### 7.1.3 Error Code during pH Calibration

During pH calibration, if pH calibration cannot be performed due to unstable pH input or temperature compensation error, etc., the error code (Table 7.1.3-1) will flash in the Temperature/Set Value Display. To release the error code, press the **MODE** key.

Confirm the standard solution and the pH Combined Electrode Sensor, and calibrate again.

If **EROUT** (Error output) is selected in [EVT1 type (pp.22, 26)], and if the error type is Error in (Table 7.1.3-1), EVT1 output will be turned ON.

The same applies to EVT2, EVT3 and EVT4.

If **FAIL** (Fail output) is selected in [EVT1 type (pp.22, 26)], and if the error type is Fail in (Table 7.1.3-1), EVT1 output will be turned ON.

The same applies to EVT2, EVT3 and EVT4.

(Table 7.1.3-1)

Error Code	Error Type	Error	Description	Occurance
<b>E-11</b>	Error	Response Speed Error	When calibrating, the response of the pH Combined Electrode Sensor is slow. When the 1st and 2nd solutions do not reach within pH $\pm 1.50$ of each pH for 5 minutes, or when pH $\pm 0.10$ or more of input fluctuation continues for 5 minutes.	When calibrating
<b>E-12</b>	Error	Electrode Sensitivity Error	When calibrating, sensitivity of the pH Combined Electrode Sensor is deteriorating. The difference of pH measured value (after calibration) between the 1st and the 2nd point is pH 2.00 or less.	
<b>E-13</b>	Error	Asymmetry Potential Error	When calibrating pH 7, the difference in electromotive force between the sensor-measured value and standard value exceeds pH $\pm 1.5$ .	
<b>E-14</b>	Error	Standard Solution Error	The specified standard solution has not been used. When pH $\pm 1.5$ is exceeded for the 1st and 2nd solutions.	
<b>E-15</b>	Error	Solution Temperature Error	When temperature is 55°C or more at pH 10 solution.	
<b>E-21</b>	Fail	Temperature Sensor Burnout	Temperature sensor lead wire is burnt out.	When measuring or calibrating
<b>E-22</b>	Fail	Temperature Sensor Short-circuited	Temperature sensor lead wire is short-circuited.	
<b>E-23</b>	Error	Outside Temperature Compensation Range	Measured temperature has exceeded 110.0°C.	
<b>E-24</b>	Error	Outside Temperature Compensation Range	Measured temperature is less than 0.0°C.	

## 7.2 Temperature Calibration Mode

To calibrate a temperature, set a temperature calibration value.

If **NONE** (No temperature compensation) is selected in [Electrode RTD (p.21)], Temperature Calibration Mode is not available.

The unit cannot enter Temperature Calibration Mode in the following cases:

- If **LOCK1** (Lock 1), **LOCK2** (Lock 2) or **LOCK3** (Lock 3) is selected in [Set value lock (p.63)].
- If **CLEG** (Cleansing output) is selected in any of [EVT1, EVT2, EVT3, EVT4 type (pp. 22, 26, 31, 35, 40, 44, 49, 53)], and when cleansing action is performing using the 'Cleansing time' and 'Restore time after cleansing' settings.

When a sensor cannot be set at the exact location where measurement is desired, the resulting measured temperature may deviate from the temperature in the desired location. In this case, the desired temperature can be set for the desired location by setting a temperature calibration value. However, it is effective within the input rated range regardless of the temperature calibration value.

Temperature after calibration = Current temperature + (Temperature calibration value)

(e.g.) When current temperature is 23.5°C,

If temperature calibration value is set to 1.5°C:  $23.5 + (1.5) = 25.0^{\circ}\text{C}$

If temperature calibration value is set to -1.5°C:  $23.5 + (-1.5) = 22.0^{\circ}\text{C}$

The following outlines the procedure for temperature calibration.

- ① Press and hold the  $\Delta$  key and  $\square_{\text{CAL}}$  key (in that order) together in pH-Temperature/ORP Display Mode, or Cleansing Output Mode.

The unit will proceed to Temperature Calibration Mode, indicated as follows.

Display	Indication
pH/ORP Display	<b>S0</b> and temperature are indicated alternately.
Temperature/Set Value Display	Temperature calibration value

- ② Set a temperature calibration value with the  $\Delta$  or  $\nabla$  key while checking temperature. Setting range: -10.0 to 10.0°C (The placement of the decimal point does not follow the selection. It is fixed.)

- ③ Press the  $\square_{\text{MODE}}$  key.

Temperature calibration is complete, and the unit reverts to pH-Temperature/ORP Display Mode, or Cleansing Output Mode.

### 7.3 Adjustment Mode

When using a brand-new sensor, please calibrate in Adjustment Mode.

By setting the adjustment value, calibrates ORP value indicated on the instrument to read 260 mV (at 20°C) when immersing the ORP Combined Electrode Sensor in the standard solution (Quinhydrone potential difference 260 mV).

The unit cannot enter Adjustment Mode in the following cases:

- If **LOCK1** (Lock 1), **LOCK2** (Lock 2) or **LOCK3** (Lock 3) is selected in [Set value lock (p.63)]
- If **CLEG** (Cleansing output) is selected in any of [EVT1, EVT2, EVT3, EVT4 type (pp. 22, 26, 31, 35, 40, 44, 49, 53)], and cleansing action is performing using the 'Cleansing time' and 'Restore time after cleansing' settings.

The following outlines the procedure for calibration.

- ① When selecting **BEFH** (Last value HOLD) in [Transmission output 1 status in Adjustment Mode, Span Sensitivity Correction Mode (p.61)] or in [Transmission output 2 status in Adjustment Mode, Span Sensitivity Correction Mode (p.62)], select it while the ORP Combined Electrode Sensor is being immersed in the solution currently calibrated.
- ② Press the **CAL** key in pH-Temperature/ORP Display Mode, or Cleansing Output Mode.  
The unit enters Adjustment Mode, indicated as follows.

Display	Indication
pH/ORP Display	<b>ADJS</b> and ORP value are indicated alternately.
Temperature/Set Value Display	Adjustment value

- ③ Immerse the ORP Combined Electrode Sensor in the standard solution (Quinhydrone potential difference 260 mV).
- ④ Set an adjustment value with the **▲** or **▼** key so that ORP value is approximately 260 mV (at 20°C).  
For other temperature and electrical potentials, refer to the temperature characteristics of your standard solution.  
Adjustment range: -200 to 200 mV
- ⑤ Press the **MODE** key.  
Adjustment Mode is complete, and the unit reverts to pH-Temperature/ORP Display Mode, or Cleansing Output Mode.

## 7.4 Span Sensitivity Correction Mode

When calibrating periodically, please calibrate in Span Sensitivity Correction Mode.

By setting the Span sensitivity correction value in percentage, calibrates ORP value indicated on the instrument to read 260 mV (at 20°C) when immersing the ORP Combined Electrode Sensor in the standard solution (Quinhydrone potential difference 260 mV).

The unit cannot enter Span Sensitivity Correction Mode in the following cases:

- If **LOCK1** (Lock 1), **LOCK2** (Lock 2) or **LOCK3** (Lock 3) is selected in [Set value lock (p.63)]
- If **CLEG** (Cleansing output) is selected in any of [EVT1, EVT2, EVT3, EVT4 type (pp. 22, 26, 31, 35, 40, 44, 49, 53)], and cleansing action is performing using the 'Cleansing time' and 'Restore time after cleansing' settings.

The following outlines the procedure for calibration.

- ① When selecting **BEFH** (Last value HOLD) in [Transmission output 1 status in Adjustment Mode, Span Sensitivity Correction Mode (p.61)] or in [Transmission output 2 status in Adjustment Mode, Span Sensitivity Correction Mode (p.62)], select it while the ORP Combined Electrode Sensor is being immersed in the solution currently calibrated.
- ② Press and hold the  $\Delta$  key and  $\text{CAL}$  key (in that order) together in pH-Temperature/ORP Display Mode, or Cleansing Output Mode.

The unit will enter Span Sensitivity Correction Mode, indicated as follows.

Display	Indication
pH/ORP Display	<b>SPAN</b> and ORP value are indicated alternately.
Temperature/Set Value Display	Span sensitivity correction value

- ③ Immerse the ORP Combined Electrode Sensor in the standard solution (Quinhydrone potential difference 260 mV).
- ④ Set a span sensitivity correction value with the  $\Delta$  or  $\nabla$  key so that ORP value is approximately 260 mV (at 20°C).  
For other temperature and electrical potentials, refer to the temperature characteristics of your standard solution.  
Setting range: 50 to 150%
- ⑤ Press the  $\text{MODE}$  key.  
Span Sensitivity Correction Mode is complete, and the unit reverts to pH-Temperature/ORP Display Mode, or Cleansing Output Mode.

## 7.5 Transmission Output 1 Adjustment Mode

Fine adjustment of Transmission output 1 is performed.

This ORP meter is adjusted at the factory, however, differences may occur between the indication value of the connected equipment (recorders, etc.) and output value of this instrument.

In this case, perform Transmission output 1 Zero adjustment and Span adjustment.

The unit cannot enter Transmission Output 1 Adjustment Mode in the following cases:

- During pH calibration, temperature calibration, Adjustment Mode, Span Sensitivity Correction Mode
- If **LOCK1** (Lock 1), **LOCK2** (Lock 2) or **LOCK3** (Lock 3) is selected in [Set value lock (p.63)]
- If **CLEG** (Cleansing output) is selected in any of [EVT1, EVT2, EVT3, EVT4 type (pp. 22, 26, 31, 35, 40, 44, 49, 53)], and cleansing action is performing using the 'Cleansing time' and 'Restore time after cleansing' settings.

The following outlines the procedure for Transmission output 1 adjustment.

- ① Press and hold the  $\Delta$  key and  $\text{SET}$  key (in that order) together for 3 seconds in pH-Temperature/ORP Display Mode, or Cleansing Output Mode.

The unit will enter Transmission Output 1 Zero Adjustment Mode, and will indicate the following.

Display	Indication
pH/ORP Display	AJZ1
Temperature/Set Value Display	Transmission output 1 Zero adjustment value

- ② Set a Transmission output 1 Zero adjustment value with the  $\Delta$  or  $\nabla$  key, while viewing the value indicated on the connected equipment (recorders, etc.).

Transmission output value (mA) changes in synchronization with the set value change.

Setting range:  $\pm 5.00\%$  of Transmission output span

- ③ Press the  $\text{SET}$  key.

The unit will enter Transmission Output 1 Span Adjustment Mode, and will indicate the following.

Display	Indication
pH/ORP Display	AJS1
Temperature/Set Value Display	Transmission output 1 Span adjustment value

- ④ Set a Transmission output 1 Span adjustment value with the  $\Delta$  or  $\nabla$  key, while viewing the value indicated on the connected equipment (recorders, etc.).

Transmission output value (mA) changes in synchronization with the set value change.

Setting range:  $\pm 5.00\%$  of Transmission output span

- ⑤ Press the  $\text{SET}$  key.

The unit reverts to Transmission Output 1 Zero Adjustment Mode.

Repeat steps ② to ⑤ if necessary.

- ⑥ To finish Transmission Output 1 Adjustment, press the  $\text{MODE}$  key in Transmission Output 1 Span Adjustment Mode.

The unit reverts to pH-Temperature/ORP Display Mode, or Cleansing Output Mode.

### Transmission Output 1 Zero and Span Adjustment Range

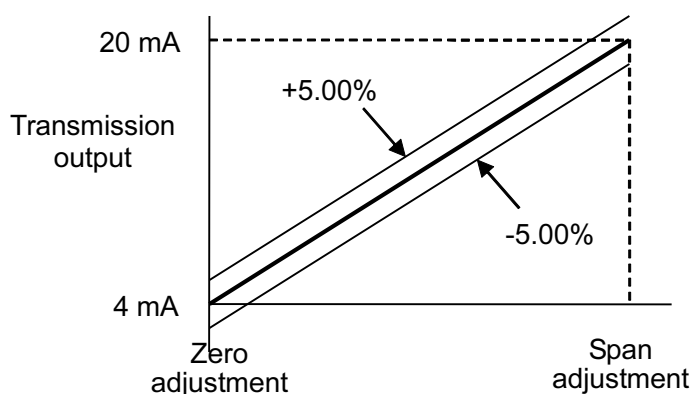

(Fig. 7.5-1)



## 7.6 Transmission Output 2 Adjustment Mode

Fine adjustment of Transmission output 2 is performed.

This ORP meter is adjusted at the factory, however, differences may occur between the indication value of the connected equipment (recorders, etc.) and output value of this instrument.

In this case, perform Transmission output 2 Zero adjustment and Span adjustment.

The unit cannot enter Transmission Output 2 Adjustment Mode in the following cases:

- During pH calibration, temperature calibration, Adjustment Mode and Span Sensitivity Correction Mode
- If **LOCK1** (Lock 1), **LOCK2** (Lock 2) or **LOCK3** (Lock 3) is selected in [Set value lock (p.63)]
- If **CLEG** (Cleansing output) is selected in any of [EVT1, EVT2, EVT3, EVT4 type (pp. 22, 26, 31, 35, 40, 44, 49, 53)], and cleansing action is performing using the 'Cleansing time' and 'Restore time after cleansing' settings.

The following outlines the procedure for Transmission output 2 adjustment.

- ① Press and hold the  $\nabla$  key and  $\text{SET}$  key (in that order) together for 3 seconds in pH-Temperature/ORP Display Mode, or Cleansing Output Mode.

The unit will enter Transmission Output 2 Zero Adjustment Mode, and will indicate the following.

Display	Indication
pH/ORP Display	AJZ2
Temperature/Set Value Display	Transmission output 2 Zero adjustment value

- ② Set a Transmission output 2 Zero adjustment value with the  $\Delta$  or  $\nabla$  key, while viewing the value indicated on the connected equipment (recorders, etc.).

Transmission output value (mA) changes in synchronization with the set value change.

Setting range:  $\pm 5.00\%$  of Transmission output span

- ③ Press the  $\text{SET}$  key.

The unit will enter Transmission Output 2 Span Adjustment Mode, and will indicate the following.

Display	Indication
pH/ORP Display	AJS2
Temperature/Set Value Display	Transmission output 2 Span adjustment value

- ④ Set a Transmission output 2 Span adjustment value with the  $\Delta$  or  $\nabla$  key, while viewing the value indicated on the connected equipment (recorders, etc.).

Transmission output value (mA) changes in synchronization with the set value change.

Setting range:  $\pm 5.00\%$  of Transmission output span

- ⑤ Press the  $\text{SET}$  key.

The unit will revert to Transmission Output 2 Zero Adjustment Mode.

Repeat steps ② to ⑤ if necessary.

- ⑥ To finish Transmission Output 2 Adjustment, press the  $\text{MODE}$  key in Transmission Output 2 Span Adjustment Mode.

The unit will revert to pH-Temperature/ORP Display Mode, or Cleansing Output Mode.

### Transmission Output 2 Zero and Span Adjustment Range

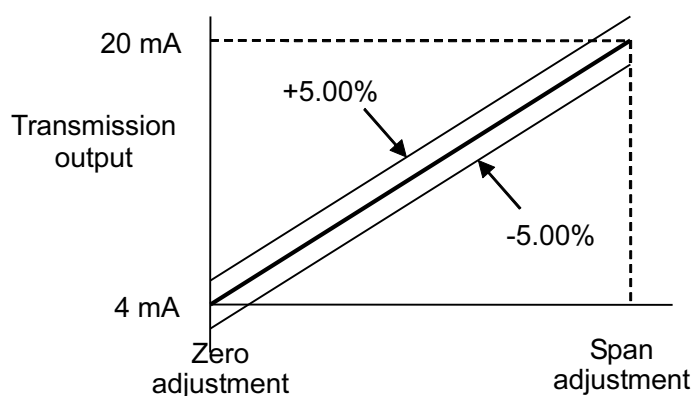

(Fig. 7.6-1)

# 8. Measurement

## 8.1 Starting Measurement

After mounting to the control panel, and wiring, setup and calibration are complete, turn the power to the instrument ON. For approx. 4 seconds after the power is switched ON, the input types are indicated in the pH/ORP Display and Temperature/Set Value Display.

pH/ORP Display	Temperature/ Set Value Display	Item Selected in [Model selection (p.64)]	Item Selected in [Electrode RTD (p.21)]
pH <input type="text"/>	Unlit	pH <input type="text"/> : pH meter	NONE <input type="text"/> : No temperature compensation
	CU500 <input type="text"/>		CU500 <input type="text"/> : Cu500
	PT100 <input type="text"/>		PT100 <input type="text"/> : Pt100
	PT1000 <input type="text"/>		PT1000 <input type="text"/> : Pt1000
ORP <input type="text"/>	Unlit	ORP <input type="text"/> : ORP meter	

After that, measurement starts, indicating the item selected in [Display selection (for pH meter)] or [Display selection (for ORP meter)] (pp. 63, 64).

When the power switch is turned ON again, the last mode (pH-Temperature/ORP Display Mode or Cleansing Output Mode) from when the power switch was turned OFF will resume.

If the  key is pressed for 3 seconds in pH-Temperature/ORP Display Mode, the unit switches to voltage indication.

By pressing the  key, the unit reverts to pH-Temperature/ORP Display Mode.

## 8.2 Error Code during Measurement

For temperature sensor error or outside temperature compensation range during measurement, their corresponding error codes flash in the Temperature/Set Value Display as shown below in (Table 8.2-1).

(Table 8.2-1)

Error Code	Error Type	Error	Description	Occurance
E-21 <input type="text"/>	Fail	Temperature sensor burnout	Temperature sensor lead wire is burnt out.	When measuring or calibrating
E-22 <input type="text"/>	Fail	Temperature sensor short-circuited	Temperature sensor lead wire is short-circuited.	
E-23 <input type="text"/>	Error	Outside temperature compensation range	Measured temperature has exceeded 110.0°C.	
E-24 <input type="text"/>	Error	Outside temperaure compensation range	Measured temperature is less than 0.0°C.	

### 8.3 Setting EVT1, EVT2, EVT3, EVT4 Values

EVT1 to EVT4 values are set in Simple Setting Mode.

These EVT1 to EVT4 values correspond to those in EVT1 to EVT4 Groups.

To enter Simple Setting Mode, follow the procedure below.

- ① **ESV1** Press the key in pH-Temperature/ORP Display Mode or Cleansing Output Mode. “EVT1 value” will be indicated.
- ② Set each setting item with the or key, and register the value with the key.

Character	Setting Item, Function, Setting Range	Factory Default
<b>ESV1</b> 0.00	<b>EVT1 value</b>  <ul style="list-style-type: none"> <li>• Sets EVT1 value.</li> <li>• Available when <b>PH-L</b>  (pH input low limit action), <b>PH-H</b>  (pH input high limit action), <b>TEMP-L</b>  (Temperature input low limit action) or <b>TEMP-H</b>  (Temperature input high limit action) is selected in [EVT1 type].</li> <li>• Setting range: pH input: pH 0.00 to 14.00 (*) Temperature input: 0.0 to 100.0°C (*) ORP input: Input low limit to Input high limit</li> </ul>	pH input: pH 0.00 Temperature input: 0.0°C ORP input: 0 mV
<b>ESV2</b> 0.00	<b>EVT2 value</b>  <ul style="list-style-type: none"> <li>• Sets EVT2 value.</li> <li>• Available when <b>PH-L</b>  (pH input low limit action), <b>PH-H</b>  (pH input high limit action), <b>TEMP-L</b>  (Temperature input low limit action) or <b>TEMP-H</b>  (Temperature input high limit action) is selected in [EVT2 type].</li> <li>• Setting range: pH input: pH 0.00 to 14.00 (*) Temperature input: 0.0 to 100.0°C (*) ORP input: Input low limit to Input high limit</li> </ul>	pH input: pH 0.00 Temperature input: 0.0°C ORP input: 0 mV
<b>ESV3</b> 0.00	<b>EVT3 value</b>  <ul style="list-style-type: none"> <li>• Sets EVT3 value.</li> <li>Available only when EVT3 or EVT4 is ordered.</li> <li>• Available when <b>PH-L</b>  (pH input low limit action), <b>PH-H</b>  (pH input high limit action), <b>TEMP-L</b>  (Temperature input low limit action) or <b>TEMP-H</b>  (Temperature input high limit action) is selected in [EVT2 type].</li> <li>• Setting range: pH input: pH 0.00 to 14.00 (*) Temperature input: 0.0 to 100.0°C (*) ORP input: Input low limit to Input high limit</li> </ul>	pH input: pH 0.00 Temperature input: 0.0°C ORP input: 0 mV
<b>ESV4</b> 0.00	<b>EVT4 value</b>  <ul style="list-style-type: none"> <li>• Sets EVT4 value.</li> <li>Available only when EVT4 is ordered.</li> <li>• Available when <b>PH-L</b>  (pH input low limit action), <b>PH-H</b>  (pH input high limit action), <b>TEMP-L</b>  (Temperature input low limit action) or <b>TEMP-H</b>  (Temperature input high limit action) is selected in [EVT4 type].</li> <li>• Setting range: pH input: pH 0.00 to 14.00 (*) Temperature input: 0.0 to 100.0°C (*) ORP input: Input low limit to Input high limit</li> </ul>	pH input: pH 0.00 Temperature input: 0.0°C ORP input: 0 mV

(\*) The placement of the decimal point does not follow the selection. It is fixed.

- ③ Press the key. The unit will revert to pH-Temperature/ORP Display Mode, or Cleansing Output Mode.

### 8.4 EVT1, EVT2, EVT3, EVT4 Outputs

When **PH-L** (pH input low limit action), **PH-H** (pH input high limit action), **TEMP-L** (Temperature input low limit action), **TEMP-H** (Temperature input high limit action), **ORP-L** (ORP input low limit action) or **ORP-H** (ORP input high limit action) is selected in [EVT1 type (pp. 22, 26)], the following action will be activated.

The same applies to EVT2, EVT3 and EVT4 output.

#### • EVT1 Action

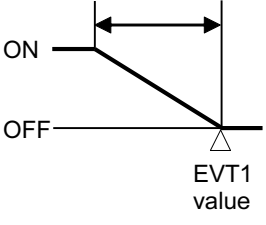
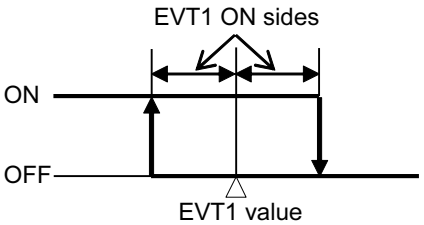
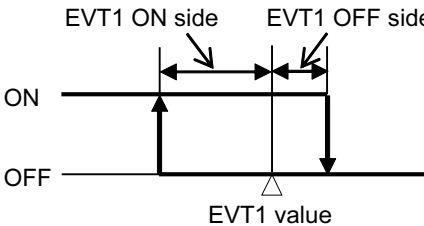
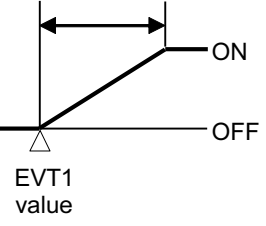
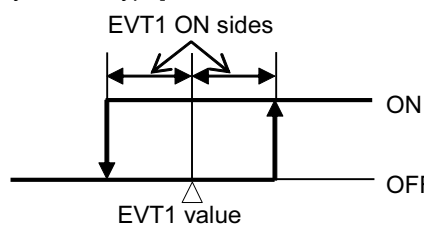
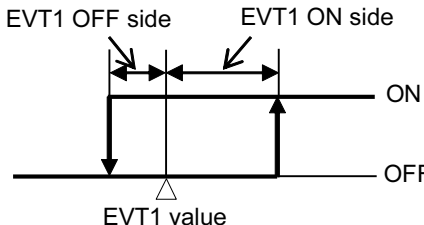
EVT1 Type	P Control Action	ON/OFF Control Action
pH input low limit action, Temperature input low limit action, ORP input low limit action	EVT1 proportional band 	If Medium Value is selected in [EVT1 hysteresis type]: 
		If Reference Value is selected in [EVT1 hysteresis type]: 
pH input high limit action, Temperature input high limit action, ORP input high limit action	EVT1 proportional band 	If Medium Value is selected in [EVT1 hysteresis type]: 
		If Reference Value is selected in [EVT1 hysteresis type]: 

(Fig. 8.4-1)

#### • P Control Action

Within the proportional band, the manipulated variable is output in proportion to the deviation between the EVT1 value and measurement value.

EVT1 Type	Description
pH input low limit action, Temperature input low limit action, ORP input low limit action	If measurement value is lower than [EVT1 value – EVT1 proportional band], EVT1 output is turned ON. If measurement value enters within the proportional band, EVT1 output is turned ON/OFF in EVT1 proportional cycles. If measurement value exceeds EVT1 value, EVT1 output is turned OFF.
pH input high limit action, Temperature input high limit action, ORP input high limit action	If measurement value is higher than [EVT1 value + EVT1 proportional band], EVT1 output is turned ON. If measurement value enters within the proportional band, EVT1 output is turned ON/OFF in EVT1 proportional cycles. If measurement value drops below EVT1 value, EVT1 output is turned OFF.

• **ON/OFF Control Action**

EVT1 Type	Description
pH input low limit action, Temperature input low limit action, ORP input low limit action	If measurement value is lower than EVT1 value, EVT1 output is turned ON. If measurement value exceeds the EVT1 value, EVT1 output is turned OFF.
pH input high limit action, Temperature input high limit action, ORP input high limit action	If measurement value is higher than EVT1 value, EVT1 output is turned ON. If measurement value drops below the EVT1 value, EVT1 output is turned OFF.

If ON and OFF time are set in [Output ON/OFF Time when EVT1 Output ON (pp. 24, 25)], and when EVT1 output is turned ON, EVT1 output is turned ON/OFF in a configured cycle.

**Timing chart of Output ON time and OFF time while in EVT1 output ON**

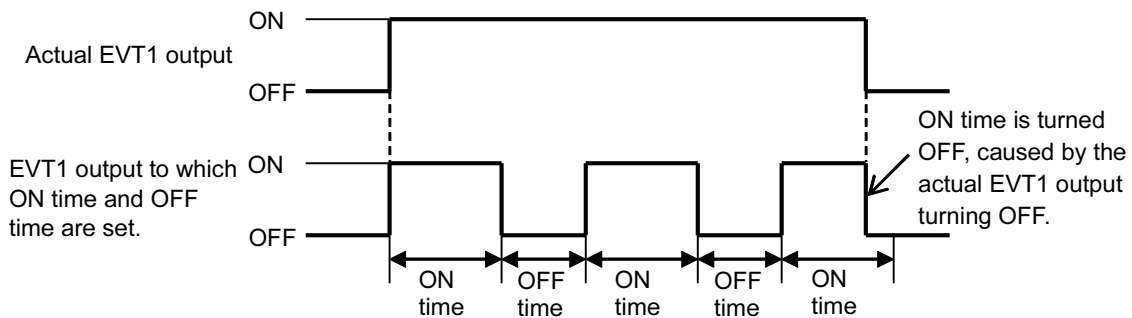

(Fig. 8.4-2)

EVT output status, when input errors occur, differs depending on the selection in [EVT output when input errors occur (p.64)].

- If **ON** [ ] [ ] [ ] [ ] (Enabled) is selected, EVT output will be maintained when input errors occur.
- If **OFF** [ ] [ ] [ ] [ ] (Disabled) is selected, EVT output will be turned OFF when input errors occur.

### 8.5 Error Output

If **EROUT** (Error output) is selected in [EVT1 type (pp. 22, 26)], and if the error type is Error in (Table 8.5-1), EVT1 output will be turned ON.

The same applies to EVT2, EVT3 and EVT4

(Table 8.5-1)

Error Code	Error Type	Error	Description	Occurance
<b>E-11</b>	Error	Response Speed Error	The response of the pH combined electrode sensor is slow. When the 1st and 2nd solutions do not reach within pH $\pm 1.50$ of each pH for 5 minutes, or when pH $\pm 0.10$ or more of input fluctuation continues for 5 minutes.	When calibrating
<b>E-12</b>	Error	Electrode Sensitivity Error	Sensitivity of the pH combined electrode sensor is deteriorating. The difference of pH measured value (after calibration) between the 1st and the 2nd point is pH 2.00 or less.	
<b>E-13</b>	Error	Asymmetry Potential Error	When calibrating pH 7, the difference in electromotive force between the sensor-measured value and standard value exceeds pH $\pm 1.5$ .	
<b>E-14</b>	Error	Standard Solution Error	The specified standard solution has not been used. When pH $\pm 1.5$ is exceeded for the 1st and 2nd solutions.	
<b>E-15</b>	Error	Solution Temperature Error	When temperature is 55°C or more at pH 10 solution.	
<b>E-21</b>	Fail	Temperature Sensor Burnout	Temperature sensor lead wire is burnt out.	When measuring or calibrating
<b>E-22</b>	Fail	Temperature Sensor Short-circuited	Temperature sensor lead wire is short-circuited.	
<b>E-23</b>	Error	Outside Temperature Compensation Range	Measured temperature has exceeded 110.0 °C.	
<b>E-24</b>	Error	Outside Temperature Compensation Range	Measured temperature is less than 0.0°C.	

### 8.6 Fail Output

If **FAIL** (Fail output) is selected in [EVT1 type (pp.22, 26)], and if the error type is Fail in (Table 8.5-1), EVT1 output will be turned ON.

The same applies to EVT2, EVT3 and EVT4.

## 8.7 Cleansing Output

If **CLEG** (Cleansing output) is selected in any of [EVT1, EVT2, EVT3, EVT4 type (pp.22, 26, 31, 35, 40, 44, 49, 53)], the unit will enter Cleansing Output Mode.

An EVT output (for which the cleansing output is selected) will turn ON during the configured cleansing time.

When the cleansing interval finishes after restore time has passed, this is counted as one cleansing cycle, and the configured number of cleansing cycles will be repeated.

While cleansing is being performed using the 'Cleansing Time' and 'Restore Time after Cleansing' settings, other outputs are in OFF status.

Measured value (pH, temperature or ORP) is retained.

When cleansing is not being performed, normal operation continues.

When power is turned ON again, the unit starts from the first cleansing cycle.

After the configured number of cleansing cycles are finished, the EVT output (for which the cleansing output is selected) is turned OFF, and other outputs perform their programmed operations, however, they are in Cleansing Output Mode.

### • Cleansing Output Action

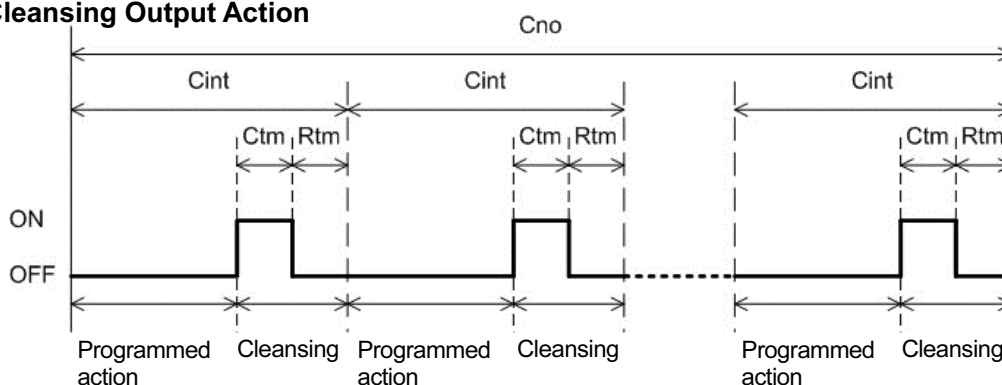

Cno: Number of cleansing cycles  
 Cint: Cleansing interval  
 Ctm: Cleansing time  
 Rtm: Restore time after cleansing

(Fig. 8.7-1)

- If **CLEG** (Cleansing output) is selected in any of [EVT1, EVT2, EVT3 or EVT4 type (pp.22, 26, 31, 35, 40, 44, 49, 53)] while performing cleansing action, the same cleansing output as the currently performing EVT output will be performed.
- If **NONE** (No temperature compensation) is selected in [Electrode RTD (p.21)], the value set in [Reference temperature] is maintained during cleansing action.  
 If an input error occurs [when temperature measured value is outside the measurement range (e.g.) less than 0.0°C or exceeding 110.0°C], the following indication will be displayed.

(Table 8.7-1)

pH/ORP Display	Temperature/Set Value Display
pH measured value	Less than 0.0°C: <b>E-24</b>
pH measured value	Exceeding 110.0°C: <b>E-23</b>

- If cleansing action initiates during Calibration Mode, Adjustment Mode, Span Sensitivity Correction Mode or Transmission output adjustment, the cleansing action will not be performed in the current session.
- If the number of cleansing cycles is changed in [Number of cleansing cycles] during cleansing action, the new number will be valid from the next cleansing cycle.

If any item except **CLEG** (Cleansing output) is selected in any of [EVT1, EVT2, EVT3 or EVT4 type (pp.22, 26, 31, 35, 40, 44, 49, 53)], the unit reverts to pH-Temperature/ORP Display Mode, or Cleansing Output Mode.

## 8.8 Manual Cleansing Mode

By pressing the  $\Delta$  and  $\nabla$  keys simultaneously for 3 seconds, the unit enters Manual Cleansing Mode. In Manual Cleansing Mode, cleansing action is performed using the 'Cleansing Time' and 'Restore Time after Cleansing' settings.

If **CLEG** (Cleansing output) is selected in any of [EVT1, EVT2, EVT3, EVT4 type (pp. 22, 26, 31, 35, 40, 44, 49, 53)], the unit can enter Manual Cleansing Mode.

After cleansing is completed, the unit automatically reverts to Cleansing Output Mode.

During cleansing action, Manual cleansing via key operation is invalidated, so the unit cannot enter Manual Cleansing Mode.

During Manual Cleansing Mode, if programmed cleansing action initiates after Restore time has passed, the cleansing action will not be performed in the current session.

Cleansing action by Manual Cleansing Mode is also counted as 1 cleansing cycle.

### Manual Cleansing Mode Action

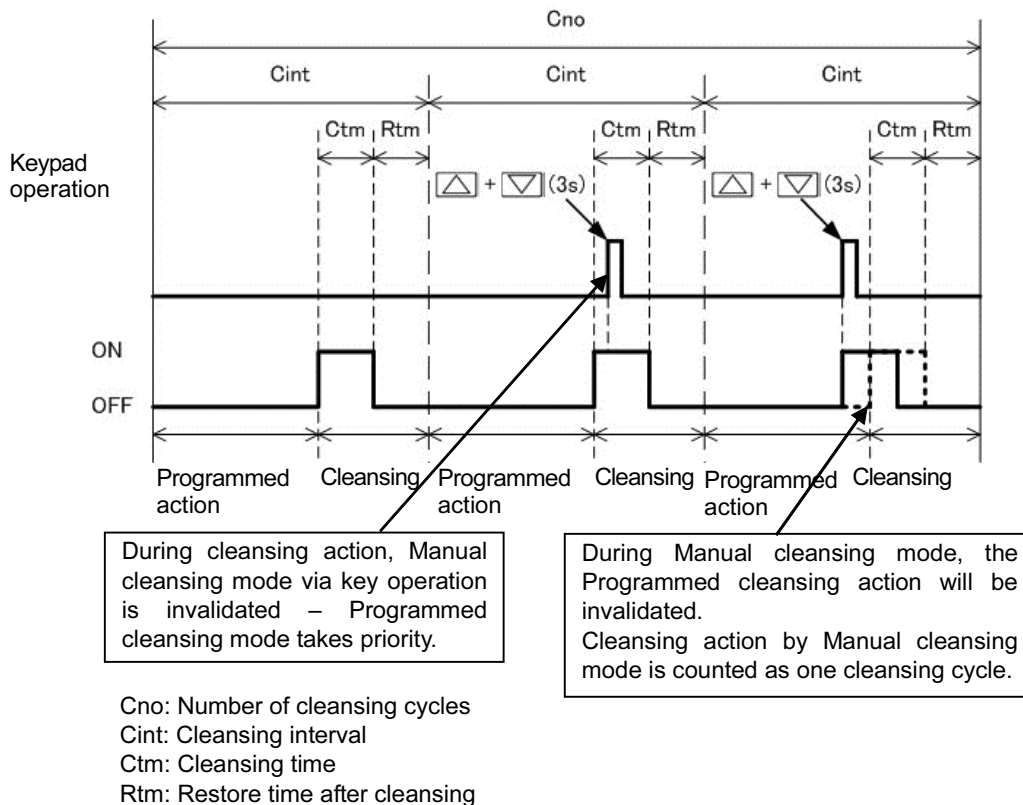

(Fig. 8.8-1)

## 8.9 pH/ORP Input Error Alarm

pH/ORP input error alarm is used for detecting actuator trouble.

Even if pH/ORP input error alarm time has elapsed, and if pH/ORP input does not become higher than pH/ORP input error alarm span, the unit assumes that actuator trouble has occurred, and writes Status flag 2.

In Serial communication, status can be read by reading Status flag 2 (EVT1, EVT2, EVT3, EVT4 output flags).

EVT1 output is turned ON when **EPUL** (pH input error alarm output) or **EOUL** (ORP input error alarm output) is selected in [EVT1 type (pp. 22, 26)].

The same applies to EVT2, EVT3 and EVT4.

pH/ORP input error alarm is disabled in the following cases.

- During pH calibration, Adjustment Mode or Span Sensitivity Correction Mode
- If **CLEG** (Cleansing output) is selected in any of [EVT1, EVT2, EVT3, EVT4 type] (p. 22, 26, 31, 35, 40, 44, 49, 53), and cleansing is being performed using the 'Cleansing Time' and 'Restore Time after Cleansing' settings
- When pH/ORP input error alarm time is set to 0 seconds (minutes), or pH/ORP input error alarm span is set to pH 0.0/0 mV.



### 8.10 Cycle Automatic Variable Function

If deviation between EVT□ value and measured value enters EVT□ cycle variable range, the proportional cycle will be automatically extended in accordance with the deviation. Proportional action OFF time will be extended, and ON / OFF ratio will be adjusted. However, if EVT□ cycle extended time is set to 0 (zero) seconds, this function will be disabled.

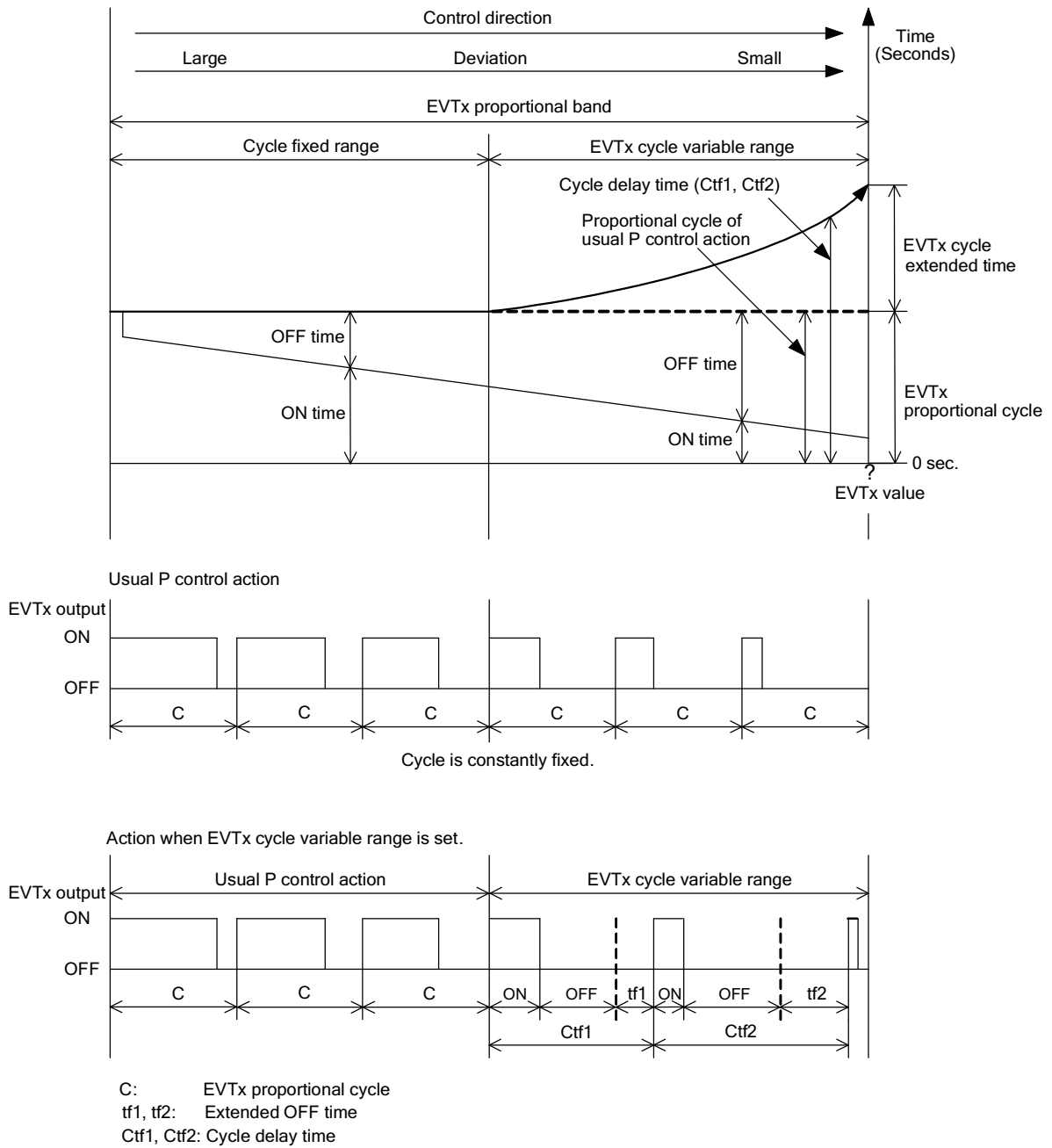

EVTx: EVT1, EVT2, EVT3 or EVT4

(Fig. 8.10-1)

### 8.11 Transmission Output

Converting pH, temperature or MV to analog signal every input sampling period, outputs in current. If **NONE** (No temperature compensation) is selected in [Electrode RTD (p.21)], and **TEMP** (Temperature transmission) is selected in [Transmission output 1 type (p.59)], the value set in [Reference temperature (p.21)] will be output.

If Transmission output 1 high limit and low limit are set to the same value, Transmission output 1 will be fixed at 4 mA DC.

The same applies to Transmission output 2.

Resolution	12000
Current	4 to 20 mA DC (Load resistance: Max 550 $\Omega$ )
Output accuracy	Within $\pm 0.3\%$ of Transmission output span

# 9. Specifications

## 9.1 Standard Specifications

### Rating

Rated Scale	Input		Input Range	Resolution
	pH Combined Electrode Sensor		pH 0.00 to 14.00	pH 0.01
ORP Combined Electrode Sensor		-2000 to 2000 mV	1 mV	
Temperature compensation	No temperature compensation			
	Pt100			
	Pt1000		0.0 to 100.0°C	0.1°C
	Cu500			
Input	pH Combined Electrode Sensor	pH sensor: Based on JIS Z8802, Temperature element: Cu500/25°C, Pt100 or Pt1000		
	ORP Combined Electrode Sensor	Temperature element: Cu500/25°C, Pt100 or Pt1000		
Supply Voltage	100 to 240 V AC 50/60Hz Allowable voltage fluctuation range: 85 to 264 V AC			

### General Structure



External Dimensions	239.5 x 190 x 75 mm (W x H x D)			
Mounting	Wall mounting			
Case	Material: Polycarbonate, Color: Metallic gray			
Front Panel	Membrane sheet			
Drip-proof/Dust-proof	IP65			
Indication Structure	LCD Display			
	pH/ORP Display	Indicates pH or ORP value. Indicates the setting item or calibration item in a setting mode or calibration mode.		
	Temperature/Set Value Display	Indicates temperature or set value. Indicates the set value or calibration value in a setting mode or calibration mode.		
	Model Display	Indicates the model.		
	Action Indicator	EV1	Indicated when EVT1 output (Contact output 1) is ON.	
		EV2	Indicated when EVT2 output (Contact output 2) is ON.	
		EV3	Indicated when EVT3 output (Contact output 3) is ON. (When EVT3 or EVT4 option is ordered)	
EV4		Indicated when EVT4 output (Contact output 4) is ON. (When EVT4 option is ordered)		
T/R	Indicated while in Serial communication TX output (transmitting) (When C5 option is ordered)			
Setting Structure	Setting method: Input system using membrane sheet key			

### Indication Performance

Repeatability	pH meter	pH $\pm 0.05$
	ORP meter	Within $\pm 5$ mV (at equivalent input)
Linearity	pH meter	pH $\pm 0.05$
	ORP meter	Within $\pm 5$ mV (at equivalent input)
Temperature Indication Accuracy	$\pm 1^\circ\text{C}$	
Input Sampling Period	125 ms (2 inputs)	
Time Accuracy	Within $\pm 1\%$ of setting time	

## Standard Functions

pH Calibration	<p>For pH measurement using the glass electrode method, pH in the sensor location, electrode performance and standard solution accuracy respectively play an important role for obtaining reliable data. Input value is shifted via 2-points calibration using the standard solutions. However, it is effective within the input rated range regardless of the calibration value. There are 2 calibration methods: Automatic Calibration, Manual Calibration.</p>																											
Temperature Calibration	<p>When a sensor cannot be set at the exact location where measurement is desired, the resulting measured temperature may deviate from the temperature in the desired location. In this case, the desired temperature can be set for the desired location by setting a temperature calibration value. However, it is effective within the input rated range regardless of the temperature calibration value.</p>																											
Adjustment Mode	<p>For successful measurement of ORP, ORP value in the sensor location, electrode performance and standard solution accuracy respectively play an important role for obtaining reliable data. By setting the adjustment value, calibrates ORP value indicated on the FEB-102-PH to read 260 mV (at 20°C) when immersing the ORP Combined Electrode Sensor in the standard solution (Quinhydrone potential difference 260 mV).</p>																											
Span Sensitivity Correction Mode	<p>By setting the Span sensitivity correction value in percentage, calibrates ORP value indicated on the FEB-102-PH to read 260 mV (at 20°C) when immersing the ORP Combined Electrode Sensor in the standard solution (Quinhydrone potential difference 260 mV).</p>																											
EVT <input type="checkbox"/> output																												
Setting accuracy	Same as Indication Accuracy																											
Output action	<p>P control: When proportional band is set to any value, except 0 (zero). ON/OFF control: When proportional band is set to 0 (zero).</p> <table border="1"> <tr> <td rowspan="3">EVT <input type="checkbox"/> proportional band</td> <td colspan="2">pH meter:</td> </tr> <tr> <td>pH input</td> <td>pH 0.00 to 14.00 (*)</td> </tr> <tr> <td>Temperature input</td> <td>0.0 to 100.0°C (*)</td> </tr> <tr> <td colspan="3">ORP meter: 0 to 4000 mV</td> </tr> <tr> <td>EVT <input type="checkbox"/> proportional cycle</td> <td colspan="2">1 to 300 seconds</td> </tr> <tr> <td rowspan="3">EVT <input type="checkbox"/> ON side, OFF side</td> <td colspan="2">pH meter:</td> </tr> <tr> <td>pH input</td> <td>pH 0.00 to 4.00 (*)</td> </tr> <tr> <td>Temperature input</td> <td>0.0 to 10.0°C (*)</td> </tr> <tr> <td colspan="3">ORP meter: 0 to 200 mV</td> </tr> <tr> <td>Output high limit, low limit</td> <td colspan="2">0 to 100%</td> </tr> </table> <p>(*) The placement of the decimal point does not follow the selection. It is fixed.</p>		EVT <input type="checkbox"/> proportional band	pH meter:		pH input	pH 0.00 to 14.00 (*)	Temperature input	0.0 to 100.0°C (*)	ORP meter: 0 to 4000 mV			EVT <input type="checkbox"/> proportional cycle	1 to 300 seconds		EVT <input type="checkbox"/> ON side, OFF side	pH meter:		pH input	pH 0.00 to 4.00 (*)	Temperature input	0.0 to 10.0°C (*)	ORP meter: 0 to 200 mV			Output high limit, low limit	0 to 100%	
EVT <input type="checkbox"/> proportional band	pH meter:																											
	pH input	pH 0.00 to 14.00 (*)																										
	Temperature input	0.0 to 100.0°C (*)																										
ORP meter: 0 to 4000 mV																												
EVT <input type="checkbox"/> proportional cycle	1 to 300 seconds																											
EVT <input type="checkbox"/> ON side, OFF side	pH meter:																											
	pH input	pH 0.00 to 4.00 (*)																										
	Temperature input	0.0 to 10.0°C (*)																										
ORP meter: 0 to 200 mV																												
Output high limit, low limit	0 to 100%																											
Type	<p>One type can be selected from the following with the keypad.</p> <table border="1"> <tr> <td> <p><b>pH meter:</b></p> <ul style="list-style-type: none"> <li>• No action</li> <li>• pH input low limit action</li> <li>• pH input high limit action</li> <li>• Temperature input low limit action</li> <li>• Temperature input high limit action</li> <li>• Error output</li> <li>• Fail output</li> <li>• Cleansing output</li> <li>• pH input error alarm output</li> </ul> </td> <td> <p><b>ORP meter:</b></p> <ul style="list-style-type: none"> <li>• No action</li> <li>• ORP input low limit action</li> <li>• ORP input high limit action</li> <li>• Cleansing output</li> <li>• ORP input error alarm output</li> </ul> </td> </tr> </table>		<p><b>pH meter:</b></p> <ul style="list-style-type: none"> <li>• No action</li> <li>• pH input low limit action</li> <li>• pH input high limit action</li> <li>• Temperature input low limit action</li> <li>• Temperature input high limit action</li> <li>• Error output</li> <li>• Fail output</li> <li>• Cleansing output</li> <li>• pH input error alarm output</li> </ul>	<p><b>ORP meter:</b></p> <ul style="list-style-type: none"> <li>• No action</li> <li>• ORP input low limit action</li> <li>• ORP input high limit action</li> <li>• Cleansing output</li> <li>• ORP input error alarm output</li> </ul>																								
<p><b>pH meter:</b></p> <ul style="list-style-type: none"> <li>• No action</li> <li>• pH input low limit action</li> <li>• pH input high limit action</li> <li>• Temperature input low limit action</li> <li>• Temperature input high limit action</li> <li>• Error output</li> <li>• Fail output</li> <li>• Cleansing output</li> <li>• pH input error alarm output</li> </ul>	<p><b>ORP meter:</b></p> <ul style="list-style-type: none"> <li>• No action</li> <li>• ORP input low limit action</li> <li>• ORP input high limit action</li> <li>• Cleansing output</li> <li>• ORP input error alarm output</li> </ul>																											
Output	<p>Relay contact 1a</p> <table border="1"> <tr> <td>Control capacity</td> <td>3A 250 V AC (Resistive load) 1A 250 V AC (Inductive load <math>\cos\phi=0.4</math>)</td> </tr> <tr> <td>Electrical life</td> <td>100,000 cycles</td> </tr> </table>		Control capacity	3A 250 V AC (Resistive load) 1A 250 V AC (Inductive load $\cos\phi=0.4$ )	Electrical life	100,000 cycles																						
Control capacity	3A 250 V AC (Resistive load) 1A 250 V AC (Inductive load $\cos\phi=0.4$ )																											
Electrical life	100,000 cycles																											
EVT ON delay time	0 to 10000 seconds																											
EVT OFF delay time	0 to 10000 seconds																											
Output ON time/ OFF time when EVT output ON	If Output ON time and OFF time are set, EVT output can be turned ON/OFF in a configured cycle when EVT output is ON.																											

Cycle Automatic Variable Function	<p>If deviation between EVT□ value and measured value enters EVT□ cycle variable range, the proportional cycle will be automatically extended in accordance with the deviation.</p> <p>Proportional action OFF time will be extended, and ON / OFF ratio will be adjusted. However, if EVT□ cycle extended time is set to 0 (zero) seconds, this function will be disabled.</p>
Cleansing Output	<p><b>Cleansing Output Mode:</b>  If <b>CLEG</b>□□ (Cleansing output) is selected in any of [EVT1, EVT2, EVT3, EVT4 type] (p. 22, 26, 31, 35, 40, 44, 49, 53), the unit will enter Cleansing Output Mode.  An EVT output (for which the cleansing output is selected) will turn ON during the configured cleansing time.  When the cleansing interval finishes after restore time has passed, this is counted as one cleansing cycle, and the configured number of cleansing cycles will be repeated.  While cleansing is being performed using the ‘Cleansing Time’ and ‘Restore Time after Cleansing’ settings, other outputs are in OFF status.  Measured value (pH, temperature or ORP value) is retained.  When cleansing is not being performed, normal operation continues.  When power is turned ON again, the unit starts from the first cleansing cycle.  After the configured number of cleansing cycles is finished, the EVT output (for which the cleansing output is selected) is turned OFF, and other outputs perform their programmed operations, however, they are in Cleansing Output Mode.</p> <p><b>Manual Cleansing Mode:</b>  By pressing the  and  keys simultaneously for 3 seconds, the unit enters Manual Cleansing Mode.  In Manual Cleansing Mode, cleansing action is performed using the ‘Cleansing Time’ and ‘Restore Time after Cleansing’ settings.  After cleansing is completed, the unit automatically reverts to Cleansing Output Mode.  During cleansing action, Manual cleansing via key operation is invalidated, so the unit cannot enter Manual Cleansing Mode.  During Manual Cleansing Mode, if Programmed cleansing action initiates after Restore time has passed, the cleansing action will not be performed in the current session.  Cleansing action by Manual Cleansing Mode is counted as 1 cleansing cycle.</p>
pH/ORP Input Error Alarm	<p>Detects actuator trouble.</p> <p>Even if pH/ORP input error alarm time has elapsed, and if pH/ORP input does not become higher than pH/ORP input error alarm span, the unit assumes that actuator trouble has occurred, and writes Status flag 2.</p> <p>In Serial communication, status can be read by reading Status flag 2 (EVT1, EVT2, EVT3, EVT4 output flags).</p> <p>EVT1 output is turned ON when <b>EPUL</b>□□ (pH input error alarm output) or <b>EOUL</b>□□ (ORP input error alarm output) is selected in [EVT1 type (pp. 22, 26)]. The same applies to EVT2, EVT3 and EVT4.</p> <p>pH/ORP input error alarm is disabled in the following cases.</p> <ul style="list-style-type: none"> <li>• During pH calibration, Adjustment Mode or Span Sensitivity Correction Mode</li> <li>• If <b>CLEG</b>□□ (Cleansing output) is selected in any of [EVT1, EVT2, EVT3, EVT4 type] (p.22, 26, 31, 35, 40, 44, 49, 53), and cleansing is being performed using the ‘Cleansing Time’ and ‘Restore Time after Cleansing’ settings.</li> <li>• When pH/ORP input error alarm time is set to 0 seconds (minutes), or pH/ORP input error alarm span is set to pH 0.0/0 mV.</li> </ul>

Transmission Output 1, 2	<p>Converting pH, temperature, ORP or MV to analog signal every input sampling period, and outputs the value in current.</p> <p>If <b>NONE</b> (No temperature compensation) is selected in [Electrode RTD (p.21)], and if <b>TEMP</b> (Temperature transmission) is selected in [Transmission output 1 type (p.59)], the value set in [Reference temperature (p.21)] will be output.</p> <p>If Transmission output 1 high limit and low limit are set to the same value, Transmission output 1 will be fixed at 4 mA DC.</p> <p>The same applies to Transmission output 2.</p> <p>(The placement of the decimal point does not follow the selection. It is fixed.)</p>	
	Resolution	12000
	Current	4 to 20 mA DC (Load resistance: Max 550 Ω)
	Output accuracy	Within ±0.3% of Transmission output span
Transmission output adjustment	For Transmission output 1 and 2, fine adjustment of Transmission output can be performed via Transmission output Zero and Span adjustment.	
Transmission output status when calibrating, or Transmission output status in Adjustment Mode or in Span Sensitivity Correction Mode	For Transmission output 1 and 2, Transmission output status when calibrating pH, Transmission output status in Adjustment Mode or in Span Sensitivity Correction Mode can be selected.	
	Last value HOLD	Retains and outputs the last value before pH calibration, or the last value before performing Adjustment Mode or Span Sensitivity Correction Mode.
	Set value HOLD	Outputs the value set in [Transmission output 1, 2 Set value HOLD].
	Measured value	Outputs the measured value when calibrating pH, or the measured value in Adjustment Mode or in Span Sensitivity Correction Mode.

### Insulation/Dielectric Strength

Circuit Insulation Configuration	<p style="text-align: center;">: When option is ordered.</p> <p>Insulation resistance: 10MΩ min., at 500 V DC</p>
Dielectric Strength	<p>Between power terminal - ground (GND): 1.5 kV AC for 1 minute</p> <p>Between input terminal - ground (GND): 1.5 kV AC for 1 minute</p> <p>Between input terminal - power terminal: 1.5 kV AC for 1 minute</p>

## Attached Functions

Set Value Lock	<p>Lock 1: None of the set values can be changed.</p> <p>Lock 2: Only EVT1, EVT2, EVT3, EVT4 values can be changed.</p> <p>Lock 3: All set values – except Electrode RTD, Temperature calibration value, pH calibration value, pH calibration Auto/Manual, Adjustment value, Span sensitivity correction value, Transmission output 1 Zero adjustment value, Transmission output 1 Span adjustment value, Transmission output 2 Zero adjustment value, Transmission output 2 Span adjustment value – can be temporarily changed.</p> <p>However, they revert to their previous value after the power is turned off because they are not saved in the non-volatile IC memory.</p>																								
pH Input Sensor Correction	<p>pH value measured by the pH Combined Electrode Sensor may deviate from the pH value in the measured location. In this case desired pH value can be obtained by adding a sensor correction value.</p> <p>However, it is effective within the measurement range regardless of the sensor correction value.</p>																								
Outside Measurement Range	<p><b>pH meter:</b></p> <p><b>If pH measured value is outside the measurement range:</b> If the value is less than pH 0.00 or exceeds pH 14.00, the following will be indicated. However, when pH measured value is outside the measurement range, and if the unit proceeds to pH Calibration Mode, the pH/ORP Display will be unlit, and the Temperature/Set Value Display will flash <b>OF</b>□□□□.</p> <p><b>If temperature measured value is outside the measurement range:</b> When the unit proceeds to pH Calibration Mode, the pH/ORP Display will be unlit, and the Temperature/Set Value Display will flash the error code.</p> <p>When <b>NONE</b>□ (No temperature compensation) is selected in [Electrode RTD (p.21)]</p> <table border="1" data-bbox="497 1079 1481 1182"> <thead> <tr> <th data-bbox="497 1079 1008 1115">pH/ORP Display</th> <th data-bbox="1015 1079 1481 1115">Temperature/Set Value Display</th> </tr> </thead> <tbody> <tr> <td data-bbox="497 1115 1008 1151">Less than pH 0.00: 0.00</td> <td data-bbox="1015 1115 1481 1151"><b>OF</b>□□□□ is flashing.</td> </tr> <tr> <td data-bbox="497 1151 1008 1182">Exceeding pH 14.00: 14.00</td> <td data-bbox="1015 1151 1481 1182"><b>OF</b>□□□□ is flashing.</td> </tr> </tbody> </table> <p>When <b>CU500</b>□ (Cu500), <b>PT100</b>□ (Pt100) or <b>PT1000</b> (Pt1000) is selected in [Electrode RTD (p.21)]:</p> <table border="1" data-bbox="497 1281 1481 1393"> <thead> <tr> <th data-bbox="497 1281 1008 1317">pH/ORP Display</th> <th data-bbox="1015 1281 1481 1317">Temperature/Set Value Display</th> </tr> </thead> <tbody> <tr> <td data-bbox="497 1317 1008 1352">Less than pH 0.00: 0.00 is flashing.</td> <td data-bbox="1015 1317 1481 1352">Temperature</td> </tr> <tr> <td data-bbox="497 1352 1008 1393">Exceeding pH 14.00: 14.00 is flashing.</td> <td data-bbox="1015 1352 1481 1393">Temperature</td> </tr> </tbody> </table> <p>When temperature measured value is outside the measurement range (Less than 0.0°C or exceeding 110.0°C), the following will be indicated.</p> <table border="1" data-bbox="497 1482 1481 1594"> <thead> <tr> <th data-bbox="497 1482 1008 1518">pH/ORP Display</th> <th data-bbox="1015 1482 1481 1518">Temperature/Set Value Display</th> </tr> </thead> <tbody> <tr> <td data-bbox="497 1518 1008 1554">pH</td> <td data-bbox="1015 1518 1481 1554">Less than 0.0°C: <b>E-24</b>□□</td> </tr> <tr> <td data-bbox="497 1554 1008 1594">pH</td> <td data-bbox="1015 1554 1481 1594">Exceeding 110.0°C: <b>E-23</b>□□</td> </tr> </tbody> </table> <p><b>ORP meter:</b></p> <p>ORP value is outside the measurement range: If the value is less than -2000 mV or exceeds 2000 mV, the following will be indicated.</p> <p>However, when ORP value is outside the measurement range, and if the unit proceeds to Adjustment Mode or Span Sensitivity Correction Mode, the pH/ORP Display will be unlit, and the Temperature/Set Value Display will flash <b>OF</b>□□□□.</p> <table border="1" data-bbox="497 1863 1481 1975"> <thead> <tr> <th data-bbox="497 1863 1008 1899">pH/ORP Display</th> <th data-bbox="1015 1863 1481 1899">Temperature/Set Value Display</th> </tr> </thead> <tbody> <tr> <td data-bbox="497 1899 1008 1935">Less than -2000 mV: -2000</td> <td data-bbox="1015 1899 1481 1935"><b>OF</b>□□□□ is flashing.</td> </tr> <tr> <td data-bbox="497 1935 1008 1975">Exceeding 2000 mV: 2000</td> <td data-bbox="1015 1935 1481 1975"><b>OF</b>□□□□ is flashing.</td> </tr> </tbody> </table>	pH/ORP Display	Temperature/Set Value Display	Less than pH 0.00: 0.00	<b>OF</b> □□□□ is flashing.	Exceeding pH 14.00: 14.00	<b>OF</b> □□□□ is flashing.	pH/ORP Display	Temperature/Set Value Display	Less than pH 0.00: 0.00 is flashing.	Temperature	Exceeding pH 14.00: 14.00 is flashing.	Temperature	pH/ORP Display	Temperature/Set Value Display	pH	Less than 0.0°C: <b>E-24</b> □□	pH	Exceeding 110.0°C: <b>E-23</b> □□	pH/ORP Display	Temperature/Set Value Display	Less than -2000 mV: -2000	<b>OF</b> □□□□ is flashing.	Exceeding 2000 mV: 2000	<b>OF</b> □□□□ is flashing.
pH/ORP Display	Temperature/Set Value Display																								
Less than pH 0.00: 0.00	<b>OF</b> □□□□ is flashing.																								
Exceeding pH 14.00: 14.00	<b>OF</b> □□□□ is flashing.																								
pH/ORP Display	Temperature/Set Value Display																								
Less than pH 0.00: 0.00 is flashing.	Temperature																								
Exceeding pH 14.00: 14.00 is flashing.	Temperature																								
pH/ORP Display	Temperature/Set Value Display																								
pH	Less than 0.0°C: <b>E-24</b> □□																								
pH	Exceeding 110.0°C: <b>E-23</b> □□																								
pH/ORP Display	Temperature/Set Value Display																								
Less than -2000 mV: -2000	<b>OF</b> □□□□ is flashing.																								
Exceeding 2000 mV: 2000	<b>OF</b> □□□□ is flashing.																								
Power Failure Countermeasure	The setting data is backed up in the non-volatile IC memory.																								
Self-diagnosis	The CPU is monitored by a watchdog timer, and if an abnormal status is found on the CPU, the FEB-102-PH is switched to warm-up status.																								

Warm-up Indication	For approx. 4 seconds after the power is switched ON, the input types are indicated in the pH/ORP Display and Temperature/Set Value Display.			
	pH/ORP Display	Temperature/Set Value Display	Item Selected in [Model Selection (p.64)]	
	pH <input type="text"/>	Unlit	pH <input type="text"/> : pH meter	NONE <input type="text"/> : No temperature compensation
		CUS00 <input type="text"/>		CUS00 <input type="text"/> : Cu500
		PT100 <input type="text"/>		PT100 <input type="text"/> : Pt100
PT1000 <input type="text"/>		PT1000 <input type="text"/> : Pt1000		
ORP <input type="text"/>	Unlit	ORP <input type="text"/> : ORP meter		
Display Selection	<p><b>pH meter:</b>  Selects items to be indicated in the pH/ORP Display and Temperature/Set Value Display.</p> <ul style="list-style-type: none"> <li>• Input value (pH, temperature)</li> <li>• pH</li> <li>• Temperature</li> </ul>			
	<p><b>ORP meter:</b>  Selects an item to be indicated in the Temperature/Set Value Display.</p> <ul style="list-style-type: none"> <li>• No indication</li> <li>• EVT1 value</li> <li>• EVT2 value</li> </ul>			
Display when No Temperature Compensation	<p>If <b>STD</b> <input type="text"/> (Reference temperature) is selected in [Display when no temperature compensation], the value set in [Reference temperature] will be indicated in the Temperature/Set Value Display.</p> <p>If <b>OFF</b> <input type="text"/> (Unlit) is selected, the Temperature/ Set Value Display will be unlit.</p> <p>If <b>TEMP</b> <input type="text"/> (Temperature) is selected in [Transmission output type], the value set in [Reference temperature] will be output.</p>			
Cable Length Correction	<p>If <b>2WIRE</b> <input type="text"/> (2-wire type) is selected in [Pt100 input wire type (p.21)], and if sensor cable is too long, temperature measurement error will occur due to cable resistance. This can be corrected by setting the cable length correction value and cable cross-section area.</p>			
Zero Indication	<p>Indicates potential difference when pH 7 is calibrated.</p> <p>However, if manual calibration is performed, zero indication value calculated at previous automatic calculation will not be updated.</p> <p>If calibration is not successfully completed, zero indication value will show the value before calibration.</p>			
Slope Indication	<p>From the voltage calibrated at pH calibration, electromotive force for the change of pH 1 will be indicated. If calibration is not successfully completed, slope indication will show the value before calibration.</p>			

#### Other

Power Consumption	Approx. 9 VA
Ambient Temperature	-20 to 50°C (Indication accuracy is applicable to 0 to 50°C range only. Direct sunlight must be avoided.)
Ambient Humidity	35 to 95%RH (non-condensing)
Weight	Approx. 950 g
Environmental Specification	RoHS directive compliant



## 9.2 Optional Specifications

### Serial Communication (Option code: C5)

Serial communication	The following operations can be carried out from an external computer. (1) Reading and setting of various set values (2) Reading of the pH, temperature, ORP value and its status (3) Function change, adjustment (4) Reading and setting of user save area			
Cable Length	1.2 km (Max), Cable resistance value: Within 50 Ω (Terminators are not necessary, but if used, use 120 Ω or more on one side.)			
Communication Line	EIA RS-485			
Communication Method	Half-duplex communication			
Communication Speed	9600, 19200, 38400 bps (Selectable by keypad)			
Synchronization Method	Start-stop synchronization			
Code Form	ASCII, Binary			
Communication Protocol	Shinko protocol, Modbus ASCII, Modbus RTU (Selectable by keypad)			
Data Bit/Parity	8-bits/No parity, 7-bits/No parity, 8-bits/Even, 7-bits/Even, 8-bits/Odd, 7-bits/Odd (Selectable by keypad)			
Stop Bit	1 bit , 2 bits (Selectable by keypad)			
Error Correction	Command request repeat system			
Error Detection	Parity check Checksum (Shinko protocol) LRC (Modbus protocol ASCII) CRC-16 (Modbus protocol RTU)			
Data Format	Communication Protocol	Shinko Protocol	Modbus ASCII	Modbus RTU
	Start bit	1 bit	1 bit	1 bit
	Data bit	7 bits	7 bits	8 bits
	Parity	Even	Even (No parity, Odd) Selectable	No parity (Even, Odd) Selectable
	Stop bit	1 bit	1 bit (2 bits) Selectable	1 bit (2 bits) Selectable

### EVT3, EVT4 Outputs (Contact outputs 3, 4) (Option Code: EVT3 or EVT4)

EVT3, EVT4 Outputs (Contact outputs 3, 4)	Same as EVT□ output (pp. 84, 85)
---	----------------------------------

# 10. Troubleshooting













If any malfunction occurs, refer to the following items after checking that power is being supplied to the FEB-102-PH.

## 10.1 Indication

Problem	Possible Cause	Solution	
Indication of the pH/ORP Display or Temperature/Set Value Display is unstable or irregular.	Electrode sensor terminal screws have become loose.	Tighten the screws.	
	Electrical insulation of electrode sensor terminals is deteriorating.	Clean the terminals with alcohol, and dry completely.	
	The electrode is not clean.	Rinse the electrode.	
	Air bubbles are attached to the electrode.	Make sure there are no bubbles in the measurement solution.	
	The electrode has not been placed in the measurement solution.	Install the electrode in the measurement solution, maintaining a consistent volume.	
	There may be equipment that interferes with or makes noise near the FEB-102-PH.	Keep FEB-102-PH clear of any potentially disruptive equipment.	
	<b>pH meter</b>		
	pH calibration and temperature calibration may not have finished.	Perform pH calibration and temperature calibration.	
	Electrode RTD selection might not be correct.	Select a correct electrode RTD.	
	Specification of pH Combined Electrode Sensor may not be suitable.	Replace the sensor with a suitable specification.	
	<b>ORP meter</b>		
	Calibration may not have finished.	Perform calibration.	
	Specification of ORP Combined Electrode Sensor may not be suitable.	Replace the sensor with a suitable specification.	
	Temperature/Set Value Display is unlit.	<b>pH meter</b>	
<b>NONE</b> [ ] (No temperature compensation) is selected in [Electrode RTD (p.21)].		Select a correct RTD type of the electrode.	
<b>NONE</b> [ ] (No temperature compensation) is selected in [Electrode RTD (p.21)], and <b>OFF</b> [ ] (unlit) is selected in [Display when no temperature compensation (p.64)].		Select <b>STD</b> [ ] (Reference temperature).	
<b>ORP meter</b>			
<b>-----</b> (No indication) is selected in [Display selection (for ORP meter)] (p.64).	Select any item other than <b>-----</b> (No indication).		
<b>[E-11]</b> [ ] is flashing in the Temperature/Set Value Display.	This shows that response of the pH Combined Electrode Sensor is slow when calibrating.	Rinse the pH Combined Electrode Sensor. If <b>[E-11]</b> [ ] is still flashing, check if the standard solution and pH Combined Electrode Sensor are normal. If they are not normal, replace the solution and sensor.	

<b>Problem</b>	<b>Possible Cause</b>	<b>Solution</b>
<b>[E-12]</b> is flashing in the Temperature/Set Value Display.	pH electrode sensitivity is deteriorating when calibrating.	Rinse the pH combined electrode sensor, and refill the internal solution. If <b>[E-12]</b> is still flashing, replace the pH Combined Electrode Sensor.
<b>[E-13]</b> is flashing in the Temperature/Set Value Display.	When calibrating, this will occur if electromotive force (asymmetry potential) of pH 7 is large.	Rinse the pH Combined Electrode Sensor, and refill the internal solution. If <b>[E-13]</b> is still flashing, replace the pH Combined Electrode Sensor.
<b>[E-14]</b> is flashing in the Temperature/Set Value Display.	When calibrating, this will occur if the specified standard solution is not used.	Rinse the pH Combined Electrode Sensor, and refill the internal solution. If <b>[E-14]</b> is still flashing, use the specified standard solution.
<b>[E-15]</b> is flashing in the Temperature/Set Value Display.	When calibrating, this will occur if temperature of pH 10 is 55°C or higher.	Check the liquid temperature of pH 10.
<b>[E-21]</b> is flashing in the Temperature/Set Value Display.	This occurs when the temperature sensor lead wire is burnt out.	Replace the pH Combined Electrode Sensor.
<b>[E-22]</b> is flashing in the Temperature/Set Value Display.	This occurs when the temperature sensor lead wire is short-circuited.	Replace the pH Combined Electrode Sensor.
<b>[E-23]</b> is flashing in the Temperature/Set Value Display.	This occurs when measured temperature value exceeds 110.0°C.	Check the environment of measurement location.
<b>[E-24]</b> is flashing in the Temperature/Set Value Display.	This occurs when measured temperature value is less than 0.0°C.	Check the environment of measurement location.
<b>[OF]</b> is flashing in the Temperature/Set Value Display.	<b>pH meter</b>	
	This indicates that the pH measured value is outside the measurement range (Less than pH 0.00, or exceeding pH 14.00.)	Check the measuring environment.
	<b>ORP meter</b>	
This indicates that ORP value is outside the measurement range (Less than -2000 mV or exceeding 2000 mV).	Check the measuring environment.	
<b>[ERR1]</b> is indicated in the pH/ORP Display.	Internal memory is defective.	Contact our agency or us.

## 10.2 Key Operation

Problem	Possible Cause	Solution
<ul style="list-style-type: none"> <li>None of the set values can be changed.</li> <li>The values do not change by the ,  keys.</li> </ul>	<b>LOCK1</b>  (Lock 1) is selected in [Set value lock (p.63)].	Select <b>-----</b> (Unlock).
<ul style="list-style-type: none"> <li>Only EVT1, EVT2, EVT3, EVT4 value can be set. Other settings are impossible.</li> <li>The values do not change by the ,  keys.</li> </ul>	<b>LOCK2</b>  (Lock 2) is selected in [Set value lock (p.63)].	Select <b>-----</b> (Unlock).
<ul style="list-style-type: none"> <li>Unable to enter Manual Cleansing Mode.</li> </ul>	<b>CLEG</b>  (Cleansing output) is not selected in any of [EVT1, EVT2, EVT3, EVT4 type (pp. 22, 26, 31, 35, 40, 44, 49, 53)].	Select <b>CLEG</b>  (Cleansing output) in any of [EVT1, EVT2, EVT3, EVT4 type (pp. 22, 26, 31, 35, 40, 44, 49, 53)].
	Cleansing action is performing using the 'Cleansing time and 'Restore time after cleansing' settings.	Execute Manual cleansing after cleansing action is complete.
<ul style="list-style-type: none"> <li>Unable to enter a calibration mode. (pH Calibration Mode, Temperature Calibration Mode, Adjustment Mode, Span Sensitivity Correction Mode)</li> </ul>	<b>LOCK1</b>  (Lock 1), <b>LOCK2</b>  (Lock 2) or <b>LOCK3</b>  (Lock 3) has been selected in [Set value lock (p.63)].	Select <b>-----</b> (Unlock).
	<b>CLEG</b>  (Cleansing output) has been selected in any of [EVT1, EVT2, EVT3, EVT4 type (pp. 22, 26, 31, 35, 40, 44, 49, 53)], and cleansing action is performing using the 'Cleansing Time' and 'Restore Time after Cleansing' settings.	Perform calibration after cleansing action is complete.

# 11. Character Tables

The following shows our character tables. Use the data column for reference. Depending on the model and settings, different items are available.

## 11.1 Setting Groups

Character	Setting Group
G_pH	pH Input Group
G_ORP	ORP Input Group
G_TMP	Temperature Input Group
G_E01	EVT1 Group
G_E02	EVT2 Group
G_E03	EVT3 Group
G_E04	EVT4 Group
G_COM	Communication Group
G_TRA	Transmission Output Group
G_CLN	Cleansing Function Group
G_OTH	Special Function Group
G_ZS	Zero/Slope Indication Group

## 11.2 pH Calibration Mode (for pH manual calibration)

Character	Setting Item, Setting Range	Factory Default	Data
1- (*)	pH calibration value	0.00	
0.00	-7.00 to 7.00		

(\*) 1- and pH are displayed alternately.

## 11.3 Temperature Calibration Mode

Character	Setting Item, Setting Range	Factory Default	Data
S0 (*)	Temperature calibration value	0.0°C	
0.0	-10.0 to 10.0°C		

(\*) S0 and temperature are displayed alternately.

## 11.4 Adjustment Mode

Character	Setting Item, Setting Range	Factory Default	Data
ADJS (*)	Adjustment value	0 mV	
0	-200 to 200 mV		

(\*) ADJS and ORP value are displayed alternately.

## 11.5 Span Sensitivity Correction Mode

Character	Setting Item, Setting Range	Factory Default	Data
SPAN (*)	Span sensitivity correction value	100%	
100	50 to 150%		

(\*) SPAN and ORP value are displayed alternately.

### 11.6 Transmission Output 1 Adjustment Mode

Character	Setting Item, Setting Range	Factory Default	Data
AJZ1 0.00	Transmission output 1 Zero adjustment value ±5.00% of Transmission output span	0.00%	
AJS1 0.00	Transmission output 1 Span adjustment value ±5.00% of Transmission output span	0.00%	

### 11.7 Transmission Output 2 Adjustment Mode

Character	Setting Item, Setting Range	Factory Default	Data
AJZ2 0.00	Transmission output 2 Zero adjustment value ±5.00% of Transmission output span	0.00%	
AJS2 0.00	Transmission output 2 Span adjustment value ±5.00% of Transmission output span	0.00%	

### 11.8 Simple Setting Mode

Character	Setting Item, Setting Range	Factory Default	Data
ESV1 0.00	EVT1 value  pH input: pH 0.00 to 14.00 Temperature input: 0.0 to 100.0°C ORP input: Input low limit to Input high limit	pH input: pH 0.00 Temperature input: 0.0°C ORP input: 0 mV	
ESV2 0.00	EVT2 value  pH input: pH 0.00 to 14.00 Temperature input: 0.0 to 100.0°C ORP input: Input low limit to Input high limit	pH input: pH 0.00 Temperature input: 0.0°C ORP input: 0 mV	
ESV3 0.00	EVT3 value  pH input: pH 0.00 to 14.00 Temperature input: 0.0 to 100.0°C ORP input: Input low limit to Input high limit	pH input: pH 0.00 Temperature input: 0.0°C ORP input: 0 mV	
ESV4 0.00	EVT4 value  pH input: pH 0.00 to 14.00 Temperature input: 0.0 to 100.0°C ORP input: Input low limit to Input high limit	pH input: pH 0.00 Temperature input: 0.0°C ORP input: 0 mV	

### 11.9 pH Input Group

Character	Setting Item, Setting Range	Factory Default	Data
TYPE <input type="checkbox"/> JIS <input type="checkbox"/>	pH 7 calibration standard JIS <input type="checkbox"/> : JIS (Japanese Industrial Standards) US <input type="checkbox"/> : US standard	JIS	
SEPH <input type="checkbox"/> PH4 <input type="checkbox"/>	2nd solution PH2 <input type="checkbox"/> : pH 2 PH4 <input type="checkbox"/> : pH 4 PH9 <input type="checkbox"/> : pH 9 PH10 <input type="checkbox"/> : pH 10	pH 4	
AJST <input type="checkbox"/> AUTO <input type="checkbox"/>	pH calibration Auto/Manual AUTO <input type="checkbox"/> : Automatic MANU <input type="checkbox"/> : Manual	Automatic	
DP1 <input type="checkbox"/> <input type="checkbox"/> 0.00	Decimal point place <input type="checkbox"/> 0: No decimal point <input type="checkbox"/> 0.0: 1 digit after decimal point <input type="checkbox"/> 0.00: 2 digits after decimal point	2 digits after decimal point	
DFCT <input type="checkbox"/> <input type="checkbox"/> 3	Moving average data amount 1 to 20	3	
FILT <input type="checkbox"/> <input type="checkbox"/> 0.0	pH input filter time constant 0.0 to 60.0 seconds	0.0 sec.	
PS0 <input type="checkbox"/> <input type="checkbox"/> 0.00	pH input sensor correction pH -1.40 to 1.40	0.00	

### 11.10 ORP Input Group

Character	Setting Item, Setting Range	Factory Default	Data
DFCT <input type="checkbox"/> <input type="checkbox"/> 3	Moving average data amount 1 to 20	3	
DSPH <input type="checkbox"/> <input type="checkbox"/> 2000	Input high limit Input low limit to 2000 mV	2000 mV	
DSPL <input type="checkbox"/> <input type="checkbox"/> -2000	Input low limit -2000 mV to Input high limit	-2000 mV	
FILT <input type="checkbox"/> <input type="checkbox"/> 0.0	ORP input filter time constant 0.0 to 60.0 seconds	0.0 sec.	

### 11.11 Temperature Input Group

Character	Setting Item, Setting Range	Factory Default	Data
SENS <input type="checkbox"/> PT100 <input type="checkbox"/>	Electrode RTD NONE <input type="checkbox"/> : No temperature compensation CU500 <input type="checkbox"/> : Cu500 PT100 <input type="checkbox"/> : Pt100 PT1000 <input type="checkbox"/> : Pt1000	Pt100	
STND <input type="checkbox"/> <input type="checkbox"/> 25.0	Reference temperature 5.0 to 95.0°C	25.0°C	
DP2 <input type="checkbox"/> <input type="checkbox"/> 0.0	Decimal point place <input type="checkbox"/> 0: No decimal point <input type="checkbox"/> 0.0: 1 digit after decimal point	1 digit after decimal point	

Character	Setting Item, Setting Range	Factory Default	Data
<b>CNECT</b> <b>3WIRE</b> <input type="checkbox"/>	<b>Pt100 input wire type</b> <b>2WIRE</b> <input type="checkbox"/> : 2-wire type <b>3WIRE</b> <input type="checkbox"/> : 3-wire type	3-wire type	
<b>CABLE</b> <input type="text"/> <b>0.0</b>	<b>Cable length correction</b> 0.0 to 100.0 m	0.0 m	
<b>CSEC</b> <input type="checkbox"/> <input type="text"/> <b>0.30</b>	<b>Cable cross-section area</b> 0.10 to 2.00 mm <sup>2</sup>	0.30 mm <sup>2</sup>	

### 11.12 EVT1 Group (When Selecting pH meter)

Character	Setting Item, Setting Range	Factory Default	Data
<b>EVT1F</b> -----	<b>EVT1 type</b> ----- : No action <b>PH-L</b> <input type="checkbox"/> : pH input low limit action <b>PH-H</b> <input type="checkbox"/> : pH input high limit action <b>TEMPL</b> <input type="checkbox"/> : Temperature input low limit action <b>TEMPH</b> <input type="checkbox"/> : Temperature input high limit action <b>EROUT</b> <input type="checkbox"/> : Error output <b>FAIL</b> <input type="checkbox"/> : Fail output <b>CLEG</b> <input type="checkbox"/> : Cleansing output <b>EPUL</b> <input type="checkbox"/> : pH input error alarm output	No action	
<b>ESV1</b> <input type="checkbox"/> <input type="text"/> <b>0.00</b>	<b>EVT1 value</b> pH input: pH 0.00 to 14.00 Temperature input: 0.0 to 100.0°C	pH input: pH 0.00 Temperature input: 0.0°C	
<b>EP1</b> <input type="checkbox"/> <input type="text"/> <b>0.00</b>	<b>EVT1 proportional band</b> pH input: pH 0.00 to 14.00 Temperature input: 0.0 to 100.0°C	pH input: pH 0.00 Temperature input: 0.0°C	
<b>E1RST</b> <input type="text"/> <b>0.00</b>	<b>EVT1 reset</b> pH input: pH ±4.00 Temperature input: ±10.0°C	pH input: pH 0.00 Temperature input: 0.0°C	
<b>E1DIF</b> <b>SDIF</b> <input type="checkbox"/>	<b>EVT1 hysteresis type</b> <b>CDIF</b> <input type="checkbox"/> : Medium value <b>SDIF</b> <input type="checkbox"/> : Reference value	Reference value	
<b>E1DFO</b> <input type="text"/> <b>0.10</b>	<b>EVT1 ON side</b> pH input: pH 0.00 to 4.00 Temperature input: 0.0 to 10.0°C	pH input: pH 0.10 Temperature input: 1.0°C	
<b>E1DFU</b> <input type="text"/> <b>0.10</b>	<b>EVT1 OFF side</b> pH input: pH 0.00 to 4.00 Temperature input: 0.0 to 10.0°C	pH input: pH 0.10 Temperature input: 1.0°C	
<b>E10NT</b> <input type="text"/> <b>0</b>	<b>EVT1 ON delay time</b> 0 to 10000 seconds	0 sec.	
<b>E10FT</b> <input type="text"/> <b>0</b>	<b>EVT1 OFF delay time</b> 0 to 10000 seconds	0 sec.	
<b>E1C</b> <input type="checkbox"/> <input type="text"/> <b>30</b>	<b>EVT1 proportional cycle</b> 1 to 300 seconds	30 sec.	



Character	Setting Item, Setting Range	Factory Default	Data
E10LH □□□100	EVT1 output high limit EVT1 output low limit to 100%	100%	
E10LL □□□□0	EVT1 output low limit 0% to EVT1 output high limit	0%	
00NT1 □□□□0	Output ON time when EVT1 output ON 0 to 10000 seconds	0 sec.	
00FT1 □□□□0	Output OFF time when EVT1 output ON 0 to 10000 seconds	0 sec.	
E1CS□ -----	EVT1 pH input error alarm EVT□ type ----- : No action EVT2□□ : EVT2 type EVT3□□ : EVT3 type EVT4□□ : EVT4 type	No action	
E1PO□ □□□□0.0	EVT1 pH input error alarm span when EVT□ output ON pH 0.0 to 14.0	pH 0.0	
E1POT □□□□0	EVT1 pH input error alarm time when EVT□ output ON 0 to 10000 seconds or minutes Time unit follows the selection in [pH/ORP input error alarm time unit].	0 sec.	
E1PC□ □□□□0.0	EVT1 pH input error alarm span when EVT□ output OFF pH 0.0 to 14.0	pH 0.0	
E1PCT □□□□0	EVT1 pH input error alarm time when EVT□ output OFF 0 to 10000 seconds or minutes (Time unit follows the selection in [pH/ORP input error alarm time unit].)	0 sec.	
MVZN1 □□50.0	EVT1 cycle variable range 1.0 to 100.0%	50.0%	
CENT1 □□□□0	EVT1 cycle extended time 0 to 300 seconds	0 sec.	

### 11.13 EVT1 Group (When Selecting ORP meter)

Character	Setting Item, Setting Range	Factory Default	Data
EVT1F -----	EVT1 type ----- : No action ORP_L□□ : ORP input low limit action ORP_H□□ : ORP input high limit action CLEG□□ : Cleansing output EOUL□□ : ORP input error alarm output	No action	
ESV1□ □□□□0	EVT1 value Input low limit to Input high limit	0 mV	
EP1□□ □□□□0	EVT1 proportional band 0 to Input span	0 mV	
E1RST □□□□0	EVT1 reset ±200 mV	0 mV	
E1DIF SDIF□□	EVT1 hysteresis type CDIF□□ : Medium value SDIF□□ : Reference value	Reference value	

Character	Setting Item, Setting Range	Factory Default	Data
E1DF0 □□□□10	EVT1 ON side 0 to 200 mV	10 mV	
E1DFU □□□□10	EVT1 OFF side 0 to 200 mV	10 mV	
E10NT □□□□0	EVT1 ON delay time 0 to 10000 seconds	0 sec.	
E10FT □□□□0	EVT1 OFF delay time 0 to 10000 seconds	0 sec.	
E1C□□ □□□□30	EVT1 proportional cycle 1 to 300 seconds	30 sec.	
E10LH □□□□100	EVT1 output high limit EVT1 output low limit to 100%	100%	
E10LL □□□□0	EVT1 output low limit 0% to EVT1 output high limit	0%	
00NT1 □□□□0	Output ON time when EVT1 output ON 0 to 10000 seconds	0 sec.	
00FT1 □□□□0	Output OFF time when EVT1 output ON 0 to 10000 seconds	0 sec.	
E1CS□□ -----	EVT1 ORP input error alarm EVT□ type ----- : No action EVT2□□ : EVT2 type EVT3□□ : EVT3 type EVT4□□ : EVT4 type	No action	
E100□□ □□□□0	EVT1 ORP input error alarm span when EVT□ output ON 0 to 2000 mV	0 mV	
E100T □□□□0	EVT1 ORP input error alarm time when EVT□ output ON 0 to 10000 seconds or minutes Time unit follows the selection in [pH/ORP input error alarm time unit].	0 sec.	
E10C□□ □□□□0	EVT1 ORP input error alarm span when EVT□ output OFF 0 to 2000 mV	0 mV	
E10CT □□□□0	EVT1 ORP input error alarm time when EVT□ output OFF 0 to 10000 seconds or minutes Time unit follows the selection in [pH/ORP input error alarm time unit].	0 sec.	
MVZN1 □□□□50.0	EVT1 cycle variable range 1.0 to 100.0%	50.0%	
CENT1 □□□□0	EVT1 cycle extended time 0 to 300 seconds	0 sec.	

### 11.14 EVT2 Group (When Selecting pH meter)

Character	Setting Item, Setting Range	Factory Default	Data
EVT2F -----	<b>EVT2 type</b> ----- : No action <b>PH_L</b> : pH input low limit action <b>PH_H</b> : pH input high limit action <b>TEMPL</b> : Temperature input low limit action <b>TEMPH</b> : Temperature input high limit action <b>EROUT</b> : Error output <b>FAIL</b> : Fail output <b>CLEG</b> : Cleansing output <b>EPUL</b> : pH input error alarm output	No action	
ESV2 0.00	<b>EVT2 value</b>  pH input: pH 0.00 to 14.00 Temperature input: 0.0 to 100.0°C	pH input: pH 0.00 Temperature input: 0.0°C	
EP2 0.00	<b>EVT2 proportional band</b>  pH input: pH 0.00 to 14.00 Temperature input: 0.0 to 100.0°C	pH input: pH 0.00 Temperature input: 0.0°C	
E2RST 0.00	<b>EVT2 reset</b>  pH input: pH ±4.00 Temperature input: ±10.0°C	pH input: pH 0.00 Temperature input: 0.0°C	
E2DIF SDIF	<b>EVT2 hysteresis type</b> <b>CDIF</b> : Medium value <b>SDIF</b> : Reference value	Reference value	
E2DF0 0.10	<b>EVT2 ON side</b>  pH input: pH 0.00 to 4.00 Temperature input: 0.0 to 10.0°C	pH input: pH 0.10 Temperature input: 1.0°C	
E2DFU 0.10	<b>EVT2 OFF side</b>  pH input: pH 0.00 to 4.00 Temperature input: 0.0 to 10.0°C	pH input: pH 0.10 Temperature input: 1.0°C	
E20NT 0	<b>EVT2 ON delay time</b> 0 to 10000 seconds	0 sec.	
E20FT 0	<b>EVT2 OFF delay time</b> 0 to 10000 seconds	0 sec.	
E2C 30	<b>EVT2 proportional cycle</b> 1 to 300 seconds	30 sec.	
E20LH 100	<b>EVT2 output high limit</b> EVT2 output low limit to 100%	100%	
E20LL 0	<b>EVT2 output low limit</b> 0% to EVT2 output high limit	0%	
00NT2 0	<b>Output ON time when EVT2 output ON</b> 0 to 10000 seconds	0 sec.	
00FT2 0	<b>Output OFF time when EVT2 output ON</b> 0 to 10000 seconds	0 sec.	

Character	Setting Item, Setting Range	Factory Default	Data
E2CS -----	EVT2 pH input error alarm EVT type EVT1 : EVT1 type ----- : No action EVT3 : EVT3 type EVT4 : EVT4 type	No action	
E2P0 0.0	EVT2 pH input error alarm span when EVT output ON pH 0.0 to 14.0	pH 0.0	
E2P0T 0	EVT2 pH input error alarm time when EVT output ON 0 to 10000 seconds or minutes Time unit follows the selection in [pH/ORP input error alarm time unit].	0 sec.	
E2PC 0.0	EVT2 pH input error alarm span when EVT output OFF pH 0.0 to 14.0	pH 0.0	
E2PCT 0	EVT2 pH input error alarm time when EVT output OFF 0 to 10000 seconds or minutes Time unit follows the selection in [pH/ORP input error alarm time unit].	0 sec.	
MVZN2 50.0	EVT2 cycle variable range 1.0 to 100.0%	50.0%	
CENT2 0	EVT2 cycle extended time 0 to 300 seconds	0 sec.	

#### 11.15 EVT2 Group (When Selecting ORP meter)

Character	Setting Item, Setting Range	Factory Default	Data
EVT2F -----	EVT2 type ----- : No action ORP_L : ORP input low limit action ORP_H : ORP input high limit action CLEG : Cleansing output EOUL : ORP input error alarm output	No action	
ESV2 0	EVT2 value Input low limit to Input high limit	0 mV	
EP2 0	EVT2 proportional band 0 to Input span	0 mV	
E2RST 0	EVT2 reset ±200 mV	0 mV	
E2DIF SDIF	EVT2 hysteresis type CDIF : Medium value SDIF : Reference value	Reference value	
E2DF0 10	EVT2 ON side 0 to 200 mV	10 mV	
E2DFU 10	EVT2 OFF side 0 to 200 mV	10 mV	
E20NT 0	EVT2 ON delay time 0 to 10000 seconds	0 sec.	
E20FT 0	EVT2 OFF delay time 0 to 10000 seconds	0 sec.	

Character	Setting Item, Setting Range	Factory Default	Data
E2C 30	EVT2 proportional cycle 1 to 300 seconds	30 sec.	
E20LH 100	EVT2 output high limit EVT2 output low limit to 100%	100%	
E20LL 0	EVT2 output low limit 0% to EVT2 output high limit	0%	
00NT2 0	Output ON time when EVT2 output ON 0 to 10000 seconds	0 sec.	
00FT2 0	Output OFF time when EVT2 output ON 0 to 10000 seconds	0 sec.	
E2CS -----	EVT2 ORP input error alarm EVT type EVT1 : EVT1 type ----- : No action EVT3 : EVT3 type EVT4 : EVT4 type	No action	
E200 0	EVT2 ORP input error alarm span when EVT output ON 0 to 2000 mV	0 mV	
E200T 0	EVT2 ORP input error alarm time when EVT output ON 0 to 10000 seconds or minutes Time unit follows the selection in [pH/ORP input error alarm time unit].	0 sec.	
E20C 0	EVT2 ORP input error alarm span when EVT output OFF 0 to 2000 mV	0 mV	
E20CT 0	EVT2 ORP input error alarm time when EVT output OFF 0 to 10000 seconds or minutes Time unit follows the selection in [pH/ORP input error alarm time unit].	0 sec.	
MVZN2 50.0	EVT2 cycle variable range 1.0 to 100.0%	50.0%	
CENT2 0	EVT2 cycle extended time 0 to 300 seconds	0 sec.	

### 11.16 EVT3 Group (When Selecting pH meter)

Character	Setting Item, Setting Range	Factory Default	Data
EVT3F -----	<b>EVT3 type</b> ----- : No action <b>PH_L</b> : pH input low limit action <b>PH_H</b> : pH input high limit action <b>TEMPL</b> : Temperature input low limit action <b>TEMPH</b> : Temperature input high limit action <b>EROUT</b> : Error output <b>FAIL</b> : Fail output <b>CLEG</b> : Cleansing output <b>EPUL</b> : pH input error alarm output	No action	
ESV3 0.00	<b>EVT3 value</b>  pH input: pH 0.00 to 14.00 Temperature input: 0.0 to 100.0°C	pH input: pH 0.00 Temperature input: 0.0°C	
EP3 0.00	<b>EVT3 proportional band</b>  pH input: pH 0.00 to 14.00 Temperature input: 0.0 to 100.0°C	pH input: pH 0.00 Temperature input: 0.0°C	
E3RST 0.00	<b>EVT3 reset</b>  pH input: pH ±4.00 Temperature input: ±10.0°C	pH input: pH 0.00 Temperature input: 0.0°C	
E3DIF SDIF	<b>EVT3 hysteresis type</b> <b>CDIF</b> : Medium value <b>SDIF</b> : Reference value	Reference value	
E3DFO 0.10	<b>EVT3 ON side</b>  pH input: pH 0.00 to 4.00 Temperature input: 0.0 to 10.0°C	pH input: pH 0.10 Temperature input: 1.0°C	
E3DFU 0.10	<b>EVT3 OFF side</b>  pH input: pH 0.00 to 4.00 Temperature input: 0.0 to 10.0°C	pH input: pH 0.10 Temperature input: 1.0°C	
E30NT 0	<b>EVT3 ON delay time</b> 0 to 10000 seconds	0 sec.	
E30FT 0	<b>EVT3 OFF delay time</b> 0 to 10000 seconds	0 sec.	
E3C 30	<b>EVT3 proportional cycle</b> 1 to 300 seconds	30 sec.	
E30LH 100	<b>EVT3 output high limit</b> EVT3 output low limit to 100%	100%	
E30LL 0	<b>EVT3 output low limit</b> 0% to EVT3 output high limit	0%	
00NT3 0	<b>Output ON time when EVT3 output ON</b> 0 to 10000 seconds	0 sec.	
00FT3 0	<b>Output OFF time when EVT3 output ON</b> 0 to 10000 seconds	0 sec.	

Character	Setting Item, Setting Range	Factory Default	Data
E3CS -----	EVT3 pH input error alarm EVT type EVT1 : EVT1 type EVT2 : EVT2 type ----- : No action EVT4 : EVT4 type	No action	
E3PO 0.0	EVT3 pH input error alarm span when EVT output ON pH 0.0 to 14.0	pH 0.0	
E3POT 0	EVT3 pH input error alarm time when EVT output ON 0 to 10000 seconds or minutes Time unit follows the selection in [pH/ORP input error alarm time unit].	0 sec.	
E3PC 0.0	EVT3 pH input error alarm span when EVT output OFF pH 0.0 to 14.0	pH 0.0	
E3PCT 0	EVT3 pH input error alarm time when EVT output OFF 0 to 10000 seconds or minutes Time unit follows the selection in [pH/ORP input error alarm time unit].	0 sec.	
MVZN3 50.0	EVT3 cycle variable range 1.0 to 100.0%	50.0%	
CENT3 0	EVT3 cycle extended time 0 to 300 seconds	0 sec.	

#### 11.17 EVT3 Group (When Selecting ORP meter)

Character	Setting Item, Setting Range	Factory Default	Data
EVT3F -----	EVT3 type ----- : No action ORP_L : ORP input low limit action ORP_H : ORP input high limit action CLEG : Cleansing output EOUL : ORP input error alarm output	No action	
ESV3 0	EVT3 value Input low limit to Input high limit	0 mV	
EP3 0	EVT3 proportional band 0 to Input span	0 mV	
E3RST 0	EVT3 reset $\pm 200$ mV	0 mV	
E3DIF SDIF	EVT3 hysteresis type CDIF : Medium value SDIF : Reference value	Reference value	
E3DF0 10	EVT3 ON side 0 to 200 mV	10 mV	
E3DFU 10	EVT3 OFF side 0 to 200 mV	10 mV	
E30NT 0	EVT3 ON delay time 0 to 10000 seconds	0 sec.	
E30FT 0	EVT3 OFF delay time 0 to 10000 seconds	0 sec.	

Character	Setting Item, Setting Range	Factory Default	Data
E3C <input type="text"/> <input type="text"/> 30	EVT3 proportional cycle 1 to 300 seconds	30 sec.	
E30LH <input type="text"/> 100	EVT3 output high limit EVT3 output low limit to 100%	100%	
E30LL <input type="text"/> 0	EVT3 output low limit 0% to EVT3 output high limit	0%	
00NT3 <input type="text"/> 0	Output ON time when EVT3 output ON 0 to 10000 seconds	0 sec.	
00FT3 <input type="text"/> 0	Output OFF time when EVT3 output ON 0 to 10000 seconds	0 sec.	
E3CS <input type="text"/> -----	EVT3 ORP input error alarm EVT <input type="text"/> type EVT1 <input type="text"/> : EVT1 type EVT2 <input type="text"/> : EVT2 type ----- : No action EVT4 <input type="text"/> : EVT4 type	No action	
E300 <input type="text"/> <input type="text"/> 0	EVT3 ORP input error alarm span when EVT <input type="text"/> output ON 0 to 2000 mV	0 mV	
E300T <input type="text"/> 0	EVT3 ORP input error alarm time when EVT <input type="text"/> output ON 0 to 10000 seconds or minutes Time unit follows the selection in [pH/ORP input error alarm time unit].	0 sec.	
E30C <input type="text"/> <input type="text"/> 0	EVT3 ORP input error alarm span when EVT <input type="text"/> output OFF 0 to 2000 mV	0 mV	
E30CT <input type="text"/> 0	EVT3 ORP input error alarm time when EVT <input type="text"/> output OFF 0 to 10000 seconds or minutes Time unit follows the selection in [pH/ORP input error alarm time unit].	0 sec.	
MVZN3 <input type="text"/> 50.0	EVT3 cycle variable range 1.0 to 100.0%	50.0%	
CENT3 <input type="text"/> 0	EVT3 cycle extended time 0 to 300 seconds	0 sec.	



11.18 EVT4 Group (When Selecting pH meter)

Character	Setting Item, Setting Range	Factory Default	Data
EVT4F -----	<b>EVT4 type</b> ----- : No action <b>pH-L</b> : pH input low limit action <b>pH-H</b> : pH input high limit action <b>TEMPL</b> : Temperature input low limit action <b>TEMPH</b> : Temperature input high limit action <b>EROUT</b> : Error output <b>FAIL</b> : Fail output <b>CLEG</b> : Cleansing output <b>EPUL</b> : pH input error alarm output	No action	
ESV4 0.00	<b>EVT4 value</b> pH input: pH 0.00 to 14.00 Temperature input: 0.0 to 100.0°C	pH input: pH 0.00 Temperature input: 0.0°C	
EP4 0.00	<b>EVT4 proportional band</b> pH input: pH 0.00 to 14.00 Temperature input: 0.0 to 100.0°C	pH input: pH 0.00 Temperature input: 0.0°C	
E4RST 0.00	<b>EVT4 reset</b> pH input: pH ±4.00 Temperature input: ±10.0°C	pH input: pH 0.00 Temperature input: 0.0°C	
E4DIF SDIF	<b>EVT4 hysteresis type</b> <b>CDIF</b> : Medium value <b>SDIF</b> : Reference value	Reference value	
E4DF0 0.10	<b>EVT4 ON side</b> pH input: pH 0.00 to 4.00 Temperature input: 0.0 to 10.0°C	pH input: pH 0.10 Temperature input: 1.0°C	
E4DFU 0.10	<b>EVT4 OFF side</b> pH input: pH 0.00 to 4.00 Temperature input: 0.0 to 10.0°C	pH input: pH 0.10 Temperature input: 1.0°C	
E40NT 0	<b>EVT4 ON delay time</b> 0 to 10000 seconds	0 sec.	
E40FT 0	<b>EVT4 OFF delay time</b> 0 to 10000 seconds	0 sec.	
E4C 30	<b>EVT4 proportional cycle</b> 1 to 300 seconds	30 sec.	
E40LH 100	<b>EVT4 output high limit</b> EVT4 output low limit to 100%	100%	
E40LL 0	<b>EVT4 output low limit</b> 0% to EVT4 output high limit	0%	
00NT4 0	<b>Output ON time when EVT4 output ON</b> 0 to 10000 seconds	0 sec.	
00FT4 0	<b>Output OFF time when EVT4 output ON</b> 0 to 10000 seconds	0 sec.	

Character	Setting Item, Setting Range	Factory Default	Data
E4CS -----	EVT4 pH input error alarm EVT type EVT1 : EVT1 type EVT2 : EVT2 type EVT3 : EVT3 type ----- : No action	No action	
E4PO 0.0	EVT4 pH input error alarm span when EVT output ON pH 0.0 to 14.0	pH 0.0	
E4POT 0	EVT4 pH input error alarm time when EVT output ON 0 to 10000 seconds or minutes Time unit follows the selection in [pH/ORP input error alarm time unit].	0 sec.	
E4PC 0.0	EVT4 pH input error alarm span when EVT output OFF pH 0.0 to 14.0	pH 0.0	
E4PCT 0	EVT4 pH input error alarm time when EVT output OFF 0 to 10000 seconds or minutes Time unit follows the selection in [pH/ORP input error alarm time unit].	0 sec.	
MVZN4 50.0	EVT4 cycle variable range 1.0 to 100.0%	50.0%	
CENT4 0	EVT4 cycle extended time 0 to 300 seconds	0 sec.	

#### 11.19 EVT4 Group (When Selecting ORP meter)

Character	Setting Item, Setting Range	Factory Default	Data
EVT4F -----	EVT4 type ----- : No action ORP_L : ORP input low limit action ORP_H : ORP input high limit action CLEG : Cleansing output EOUL : ORP input error alarm output	No action	
ESV4 0	EVT4 value Input low limit to Input high limit	0 mV	
EP4 0	EVT4 proportional band 0 to Input span	0 mV	
E4RST 0	EVT4 reset $\pm 200$ mV	0 mV	
E4DIF SDIF	EVT4 hysteresis type CDIF : Medium value SDIF : Reference value	Reference value	
E4DF0 10	EVT4 ON side 0 to 200 mV	10 mV	
E4DFU 10	EVT4 OFF side 0 to 200 mV	10 mV	
E40NT 0	EVT4 ON delay time 0 to 10000 seconds	0 sec.	
E40FT 0	EVT4 OFF delay time 0 to 10000 seconds	0 sec.	

Character	Setting Item, Setting Range	Factory Default	Data
E4C□□ □□□30	EVT4 proportional cycle 1 to 300 seconds	30 sec.	
E40LH □□□100	EVT4 output high limit EVT4 output low limit to 100%	100%	
E40LL □□□□0	EVT4 output low limit 0% to EVT4 output high limit	0%	
00NT4 □□□□0	Output ON time when EVT4 output ON 0 to 10000 seconds	0 sec.	
00FT4 □□□□0	Output OFF time when EVT4 output ON 0 to 10000 seconds	0 sec.	
E4CS□□ -----	EVT4 ORP input error alarm EVT□ type EVT1□□ : EVT1 type EVT2□□ : EVT2 type EVT3□□ : EVT3 type ----- : No action	No action	
E400□□ □□□□0	EVT4 ORP input error alarm span when EVT□ output ON 0 to 2000 mV	0 mV	
E400T □□□□0	EVT4 ORP input error alarm time when EVT□ output ON 0 to 10000 seconds or minutes Time unit follows the selection in [pH/ORP input error alarm time unit].	0 sec.	
E40C□□ □□□□0	EVT4 ORP input error alarm span when EVT□ output OFF 0 to 2000 mV	0 mV	
E40CT □□□□0	EVT4 ORP input error alarm time when EVT□ output OFF 0 to 10000 seconds or minutes Time unit follows the selection in [pH/ORP input error alarm time unit].	0 sec.	
MVZN4 □□50.0	EVT4 cycle variable range 1.0 to 100.0%	50.0%	
CENT4 □□□□0	EVT4 cycle extended time 0 to 300 seconds	0 sec.	

### 11.20 Communication Group

Character	Setting Item, Setting Range	Factory Default	Data
<b>CMSL</b> <b>NOML</b>	<b>Communication protocol</b> <b>NOML</b> : Shinko protocol <b>MODA</b> : Modbus ASCII mode <b>MODR</b> : Modbus RTU mode	Shinko protocol	
<b>CMNO</b> 0	<b>Instrument number</b> 0 to 95	0	
<b>CMSP</b> 9600	<b>Communication speed</b> 9600 : 9600 bps 19200 : 19200 bps 38400 : 38400 bps	9600 bps	
<b>CMFT</b> <b>7EVN</b>	<b>Data bit/Parity</b> <b>8NON</b> : 8 bits/No parity <b>7NON</b> : 7 bits/No parity <b>8EVN</b> : 8 bits/Even <b>7EVN</b> : 7 bits/Even <b>8ODD</b> : 8 bits/Odd <b>7ODD</b> : 7 bits/Odd	7 bits/Even	
<b>CMST</b> 1	<b>Stop bit</b> 1 : 1 bit 2 : 2 bits	Stop bit 1	

### 11.21 Transmission Output Group (When selecting pH meter)

Character	Setting Item, Setting Range	Factory Default	Data
<b>TROS1</b> <b>pH</b>	<b>Transmission output 1 type</b> <b>pH</b> : pH transmission <b>TEMP</b> : Temperature transmission <b>MV1</b> : EVT1 MV transmission <b>MV2</b> : EVT2 MV transmission	pH transmission	
<b>TRLH1</b> 14.00	<b>Transmission output 1 high limit</b>  pH transmission: Transmission output 1 low limit to pH 14.00 Temperature transmission: Transmission output 1 low limit to 100.0°C MV transmission: Transmission output 1 low limit to 100.0%	pH transmission: pH 14.00 Temperature transmission: 100.0°C MV transmission: 100.0%	
<b>TRLL1</b> 0.00	<b>Transmission output 1 low limit</b>  pH transmission: pH 0.00 to Transmission output 1 high limit Temperature transmission: 0.0°C to Transmission output 1 high limit MV transmission: 0.0% to Transmission output 1 high limit	pH transmission: pH 0.00 Temperature transmission: 0.0°C MV transmission: 0.0%	
<b>TRCS1</b> <b>BEFH</b>	<b>Transmission output 1 status when calibrating</b> <b>BEFH</b> : Last value HOLD <b>SETH</b> : Set value HOLD <b>PVH</b> : Measured value	Last value HOLD	
<b>TRSE1</b> 0.00	<b>Transmission output 1 Set value HOLD</b>  pH transmission: pH 0.00 to 14.00 Temperature transmission: 0.0 to 100.0°C MV transmission: 0.0 to 100.0%	pH transmission: pH 0.00 Temperature transmission: 0.0°C MV transmission: 0.0%	

Character	Setting Item, Setting Range	Factory Default	Data
<b>TROS2</b> <b>pH</b> [ ] [ ] [ ] [ ]	<b>Transmission output 2 type</b> <b>pH</b> [ ] [ ] [ ] [ ] : pH transmission <b>TEMP</b> [ ] [ ] : Temperature transmission <b>MV1</b> [ ] [ ] [ ] [ ] : EVT1 MV transmission <b>MV2</b> [ ] [ ] [ ] [ ] : EVT2 MV transmission <b>MV3</b> [ ] [ ] [ ] [ ] : EVT3 MV transmission	pH transmission	
<b>TRLH2</b> [ ] [ ] [ ] <b>14.00</b>	<b>Transmission output 2 high limit</b>  pH transmission: Transmission output 2 low limit to pH 14.00 Temperature transmission: Transmission output 2 low limit to 100.0°C MV transmission: Transmission output 2 low limit to 100.0%	pH transmission: pH 14.00 Temperature transmission: 100.0°C MV transmission: 100.0%	
<b>TRLL2</b> [ ] [ ] [ ] <b>0.00</b>	<b>Transmission output 2 low limit</b>  pH transmission: pH 0.00 to Transmission output 2 high limit Temperature transmission: 0.0°C to Transmission output 2 high limit MV transmission: 0.0% to Transmission output 2 high limit	pH transmission: pH 0.00 Temperature transmission: 0.0°C MV transmission: 0.0%	
<b>TRCS2</b> <b>BEFH</b> [ ] [ ]	<b>Transmission output 2 status when calibrating</b> <b>BEFH</b> [ ] [ ] : Last value HOLD <b>SETH</b> [ ] [ ] : Set value HOLD <b>PVH</b> [ ] [ ] [ ] [ ] : Measured value	Last value HOLD	
<b>TRSE2</b> [ ] [ ] [ ] <b>0.00</b>	<b>Transmission output 2 Set value HOLD</b>  pH transmission: pH 0.00 to 14.00 Temperature transmission: 0.0 to 100.0°C MV transmission: 0.0 to 100.0%	pH transmission: pH 0.00 Temperature transmission: 0.0°C MV transmission: 0.0%	

### 11.22 Transmission Output Group (When selecting ORP meter)

Character	Setting Item, Setting Range	Factory Default	Data
<b>TROS1</b> <b>ORP</b>	<b>Transmission output 1 type</b> <b>ORP</b> : ORP transmission <b>MV1</b> : EVT1 MV transmission <b>MV2</b> : EVT2 MV transmission	ORP transmission	
<b>TRLH1</b> <b>2000</b>	<b>Transmission output 1 high limit</b>  ORP transmission: Transmission output 1 low limit to 2000 mV MV transmission: Transmission output 1 low limit to 100.0%	ORP transmission: 2000 mV MV transmission: 100.0%	
<b>TRLL1</b> <b>-2000</b>	<b>Transmission output 1 low limit</b>  ORP transmission: -2000 mV to Transmission output 1 high limit MV transmission: 0.0% to Transmission output 1 high limit	ORP transmission: -2000 mV MV transmission: 0.0%	
<b>TRCS1</b> <b>BEFH</b>	<b>Transmission output 1 status in Adjustment Mode, Span Sensitivity Correction Mode</b> <b>BEFH</b> : Last value HOLD <b>SETH</b> : Set value HOLD <b>PVH</b> : Measured value	Last value HOLD	
<b>TRSE1</b> <b>0.00</b>	<b>Transmission output 1 Set value HOLD</b> ORP transmission: -2000 to 2000 mV MV transmission: 0.0 to 100.0%	ORP transmission: 0 mV MV transmission: 0.0%	
<b>TROS2</b> <b>ORP</b>	<b>Transmission output 2 type</b> <b>ORP</b> : ORP transmission <b>MV1</b> : EVT1 MV transmission <b>MV2</b> : EVT2 MV transmission <b>MV3</b> : EVT3 MV transmission	ORP transmission	
<b>TRLH2</b> <b>2000</b>	<b>Transmission output 2 high limit</b>  ORP transmission: Transmission output 2 low limit to 2000 mV MV transmission: Transmission output 2 low limit to 100.0%	ORP transmission: 2000 mV MV transmission: 100.0%	
<b>TRLL2</b> <b>-2000</b>	<b>Transmission output 2 low limit</b>  ORP transmission: -2000 mV to Transmission output 2 high limit MV transmission: 0.0% to Transmission output 2 high limit	ORP transmission: -2000 mV MV transmission: 0.0%	
<b>TRCS2</b> <b>BEFH</b>	<b>Transmission output 2 status in Adjustment Mode, Span Sensitivity Correction Mode</b> <b>BEFH</b> : Last value HOLD <b>SETH</b> : Set value HOLD <b>PVH</b> : Measured value	Last value HOLD	
<b>TRSE2</b> <b>0.00</b>	<b>Transmission output 2 Set value HOLD</b> ORP transmission: -2000 to 2000 mV MV transmission: 0.0 to 100.0%	ORP transmission: 0 mV MV transmission: 0.0%	

### 11.23 Cleansing Function Group

Character	Setting Item, Setting Range	Factory Default	Data
CCNT 0	Number of cleansing cycles 0 to 10 times (0: Continuous cleansing)	0 (Continuous cleansing)	
CCYC 360	Cleansing interval 60 to 3000 minutes	360 minutes	
CTIM 600	Cleansing time 1 to 1800 seconds	600 sec.	
CREC 600	Restore time after cleansing 1 to 1800 seconds	600 sec.	

### 11.24 Special Function Group

Character	Setting Item, Setting Range	Factory Default	Data
LOCK -----	Set value lock ----- : Unlock LOCK1 : Lock 1 LOCK2 : Lock 2 LOCK3 : Lock 3	Unlock	
DISP DUAL	Display selection (for pH meter) DUAL : Input value (pH, Temperature) pH : pH TEMP : Temperature	Input value (pH, Temperature)	
DISP -----	Display selection (for ORP meter) ----- : No indication ESV1 : EVT1 value ESV2 : EVT2 value	No indication	
INERR OFF	EVT output when input errors occur ON : Enabled OFF : Disabled	Disabled	
OFDP OFF	Display when no temperature compensation STD : Reference temperature OFF : Unlit	Unlit	
M_S SEC	pH/ORP input error alarm time unit SEC : Second(s) MIN : Minute(s)	Second(s)	
MODEL pH	Model selection pH : pH meter ORP : ORP meter	pH meter	

### 11.25 Zero/Slope Indication Group

Character	Setting Item, Setting Range	Factory Default	Data
ZERO 0.0	Zero indication Voltage equivalent to pH $\pm 1.5$	0.0 mV	
SLOP 59.2	Slope indication Voltage equivalent to pH 0.00 to 14.00	59.2 mV	

# 12. Key Operation Flowchart

Abbreviation:  
Trans.: Transmission

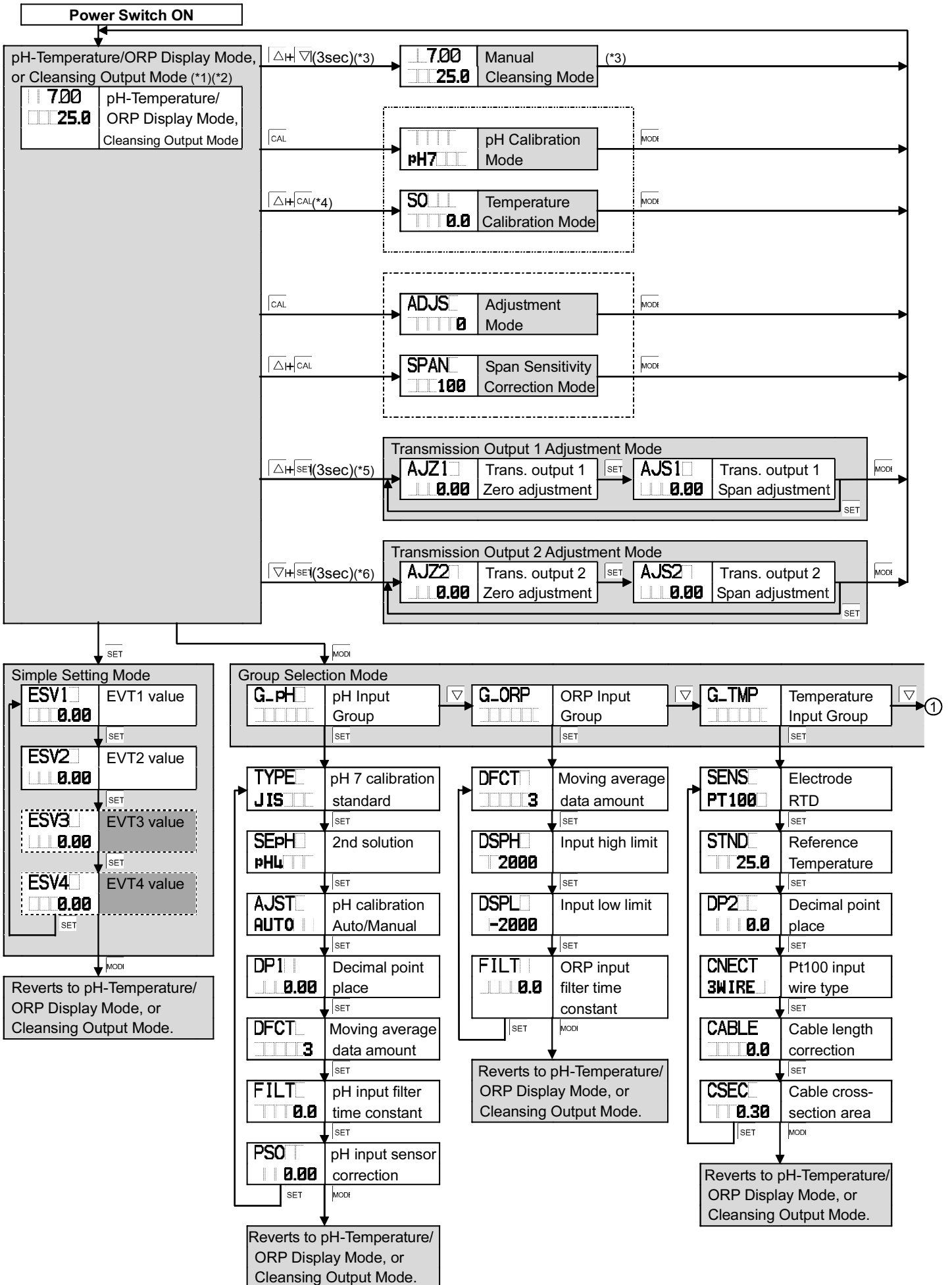



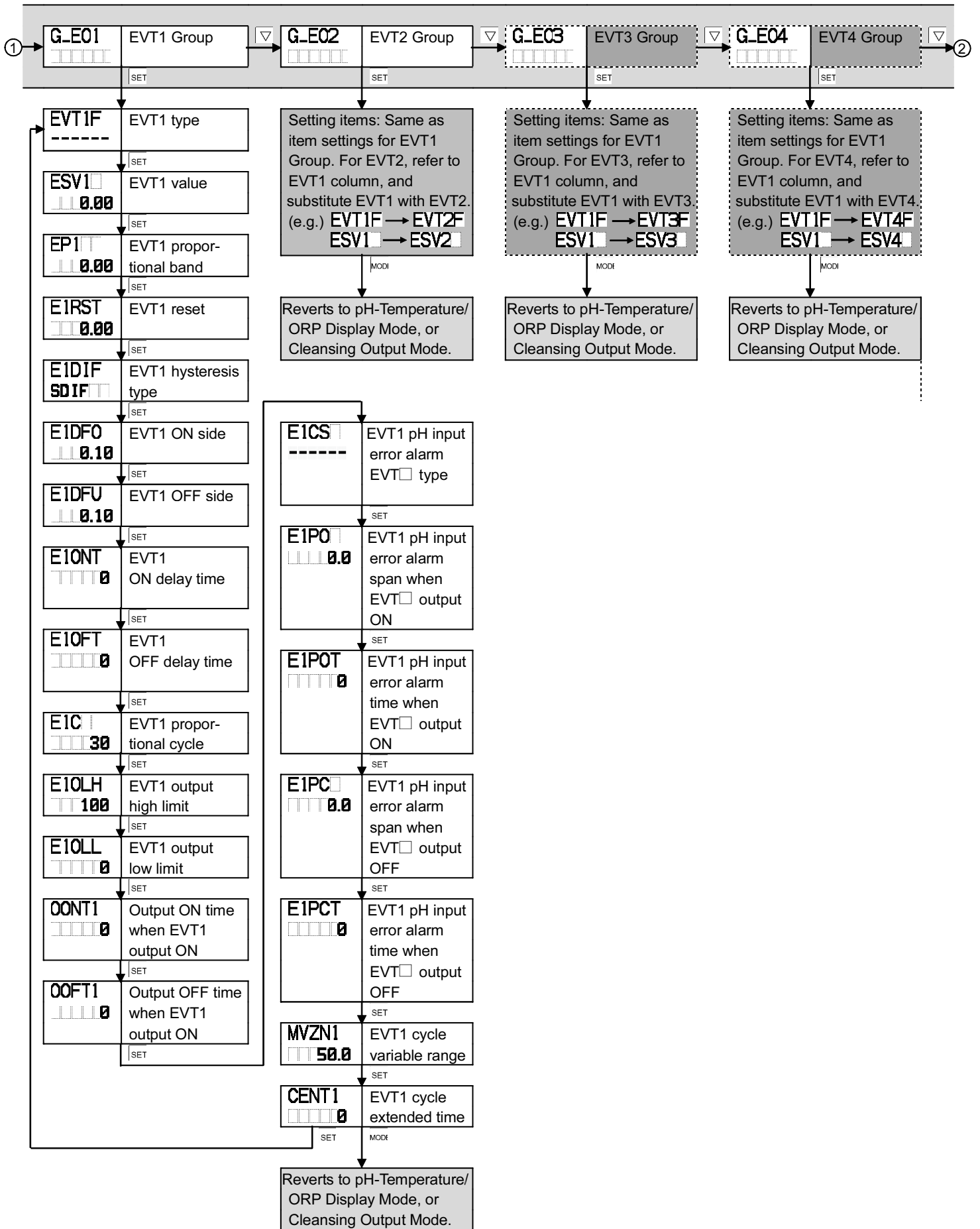

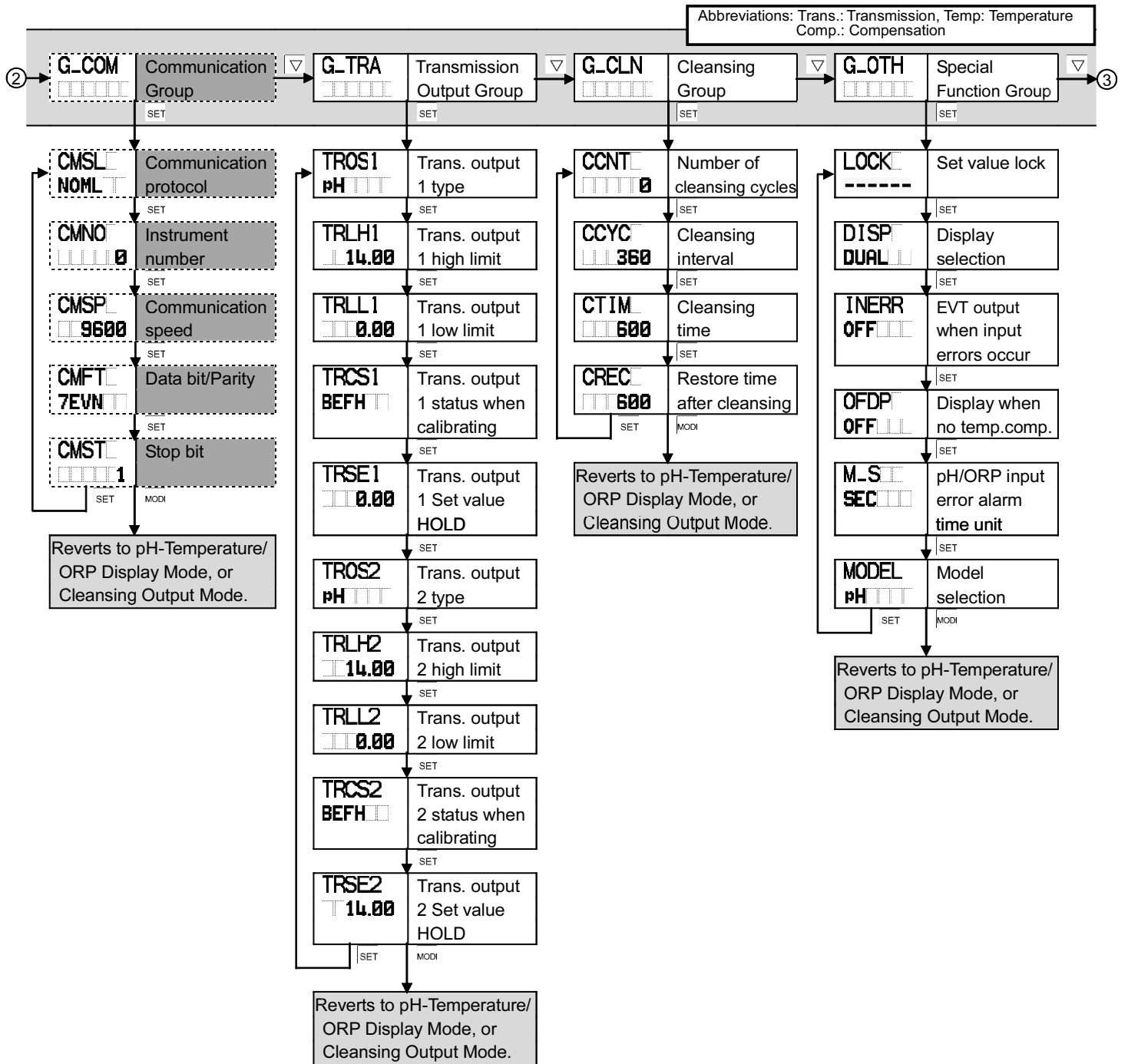

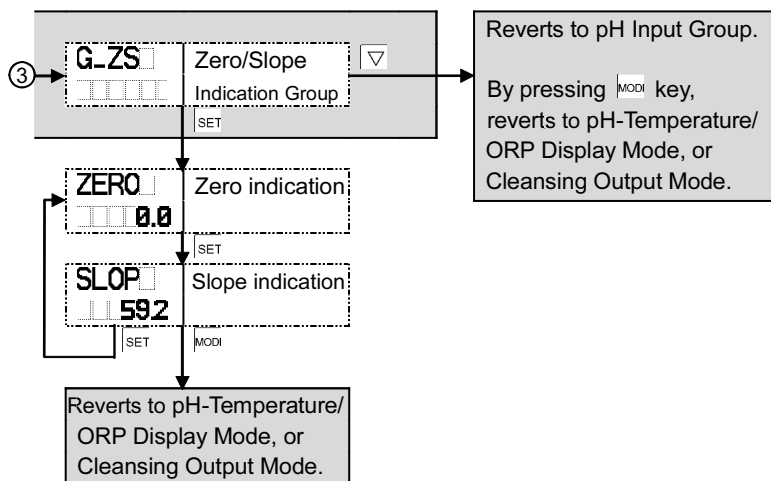

[About each mode and setting item]

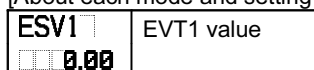

- Upper left: pH/ORP Display: Indicates the setting item characters.
- Lower left: Temperature/Set Value Display: Indicates the factory default.
- Right side: Indicates the setting item.

(\*1) Indicates the item selected in [Display selection (for pH/ORP meters)] or [Display selection (for ORP meter)] (pp.63, 64) in pH-Temperature/ORP Display Mode, or Cleansing Output Mode.

When the power switch is turned ON again, the last mode (pH-Temperature/ORP Display Mode or Cleansing Output Mode) from when the power switch was turned OFF will resume.

(\*2) If the  $\Delta$  key is pressed for approx. 3 seconds in pH-Temperature/ORP Display Mode, or Cleansing Output Mode, the unit will be switched to voltage indication.

If the  $\text{SE}^-$  key is pressed, the unit will revert to pH-Temperature/ORP Display Mode, or Cleansing Output Mode.

(\*3) If **CLEG** (Cleansing output) is selected in any of [EVT1, EVT2, EVT3, EVT4 type (pp. 22, 26, 31, 35, 40, 44, 49, 53)], the unit will proceed to the Manual Cleansing Mode. After cleansing action is complete, the unit automatically reverts to Cleansing Output Mode.

(\*4) If **NONE** (No temperature compensation) is selected in [Electrode RTD (p.21)], the unit will not move to Temperature Calibration Mode.

(\*5) If C5, EVT3 or EVT4 option is ordered, the unit will not enter Transmission Output 1 Adjustment Mode.

(\*6) If C5 or EVT4 is ordered, the unit will not enter Transmission Output 2 Adjustment Mode.

: Available only when the option is ordered.

: Available when **ORP** (ORP meter) is selected in Section 6.2 Model Selection (p.18).

: Available when **PH** (pH meter) is selected in Section 6.2 Model Selection (p.18).

[Key operation]

- $\text{SE}^-$ ,  $\text{CAL}$ ,  $\text{MOD}$ ,  $\nabla$ : If the  $\text{SE}^-$ ,  $\text{CAL}$ ,  $\text{MOD}$  or  $\nabla$  key is pressed, the unit will proceed to the next setting item, illustrated by an arrow.
- $\Delta + \nabla$  (3 sec): Press and hold the  $\Delta$  and  $\nabla$  keys (in that order) together for approx. 3 seconds. The unit will enter Manual Cleansing Mode.
- $\Delta + \text{CAL}$ : Press and hold the  $\Delta$  and  $\text{CAL}$  keys (in that order) together. The unit will enter Span Sensitivity Correction Mode.
- $\Delta + \text{SE}^-$  (3 sec): Press and hold the  $\Delta$  and  $\text{SE}^-$  keys (in that order) together for 3 seconds. The unit will proceed to Transmission Output 1 Adjustment Mode.
- $\nabla + \text{SE}^-$  (3 sec): Press and hold the  $\nabla$  and  $\text{SE}^-$  keys (in that order) together for 3 seconds. The unit will proceed to Transmission Output 2 Adjustment Mode.
- If the  $\text{MOD}$  key is pressed at each setting item, the unit will revert to pH-Temperature/ORP Display Mode, or Cleansing Output Mode.

\*\*\*\*\* Inquiries \*\*\*\*\*

For any inquiries about this unit, please contact our agency or the vendor where you purchased the unit after checking the following.

[Example]

- Model ----- FEB-102-PH
- Serial number ----- No. 156F05000

In addition to the above, please let us know the details of the malfunction, or discrepancy, and the operating conditions.

**SHINKO TECHNOS CO., LTD.**  
**OVERSEAS DIVISION**

Head Office : 2-5-1, Senbahigashi, Minoo, Osaka, Japan

URL: <http://www.shinko-technos.co.jp/e/>

E-mail: [overseas@shinko-technos.co.jp](mailto:overseas@shinko-technos.co.jp)

Tel : +81-72-727-6100

Fax: +81-72-727-7006