

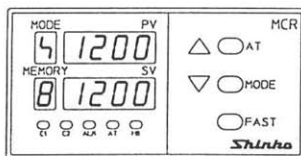

INSTRUCTION MANUAL
FOR
MICROCOMPUTER BASED
TEMPERATURE INDICATING CONTROLLER
MCR-200 SERIES



— CONTENTS —

1. Model names	2
2. Name and functions of the sections	4
3. Mounting to control panel	6
4. Wiring connection	7
5. Operations	9
6. Control actions	23
7. Running	25
8. Maintenance and checking	28
9. Specifications	29
10. Character table	32

Thank you for your purchase of our Microcomputer based Temperature Indicating Controller MCR-200 Series.

This controller is delivered after its production and inspection on the basis of severe quality control in our factory.

Further to your confirmation of the model and specifications of the controller, peruse this instruction manual before starting operation.

Note:

Please arrange to give this manual into the hands of the operator who actually uses our product.

1. Model names

1.1 Standard models

MCR-2	<input type="checkbox"/>	<input type="checkbox"/>	<input type="checkbox"/>	<input type="checkbox"/>	Series name: MCR-200 series
Control action	3				PID action
Temperature alarm action	0				No alarm action
	2				High limit alarm
	3				Low limit alarm
	4				High/low limits alarm
	6				High/low limit range alarm
	8				Process value alarm
Main output	R				Relay contact
	S				Non-contact voltage
	A				Current
Input	E				Thermocouple K, J, PL-II, R, S, B, C, T
	R				RTD Pt100 (3-wire system)

1.2 Optional specifications

Optional name	Code	Description
Temperature alarm with standby function	H	The standby alarm function disables alarm action until the temperature passes over the alarm setpoint on initial start.
Temperature alarm function (A2 output)	AL <input type="checkbox"/>	Additional temperature alarm besides the alarm of the standard specification. The action is specified in <input type="checkbox"/> . (AL2, AL3, AL4, AL6, AL8)
Temp. alarm (A2) function with standby	AL <input type="checkbox"/> H	Standby function is added to temperature alarm function (A2), and the action is specified in <input type="checkbox"/> . (AL2H, AL3H, AL4H)
Heater burnout alarm function.	W	Watches heater current through CT (current transformer), and when the heater current goes down lower than setting value, it gives alarm. Current: 5A, 10A or 20A (specified)
Heating/Cooling control output	D <input type="checkbox"/>	Control output individually works with heating and cooling control mode. Cooling output(C2) <input type="checkbox"/> : Relay contact [DR], Non-contact voltage [DS]
Setting value memory function	SM	The function which memorizes 7 kinds of data in 8 files. (Main setting value, PID each value, ARW value, Temperature alarm setting value and Dead band setting value)
Serial communication	C 5	The function to transmit the data with EIA RS-485.

External setting	E C C	It does not memorize the main setting value command in digital signal (RS-485) from host device (PC-600 series, SVTC) into internal memory, and reads it directly. [This option cannot be applied together with (W), (C5).]
Color Black	B K	Face plate: Dark gray Case, Base: Black
Screw type mounting bracket	B L	Mounting Panel thickness 1 to 8 mm. (Standard mounting bracket is one touch system.)

1.3 Explanation of model name

Discribed mark "□" in this manual such as -R/□ or -□/□ means an alphanumerical character which shows various functions or the kinds. (e.g. R/E or S/R)

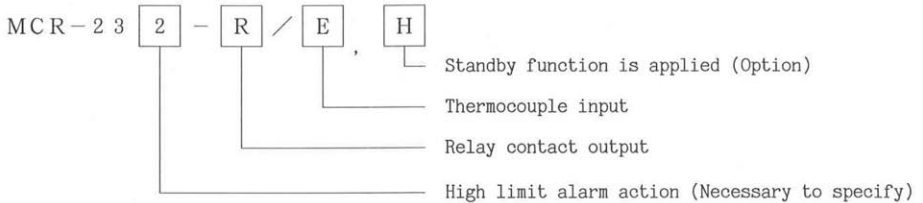

1.4 How to indicate optional specifications

- ① Optional specifications are specified by the option code (described in the preceding page) besides the model name.
- ② When two or more functions are specified, they are delimited with comma.
- ③ As to specified Heater burnout alarm action W, the specified value is to be indicated following to the option code in (A).

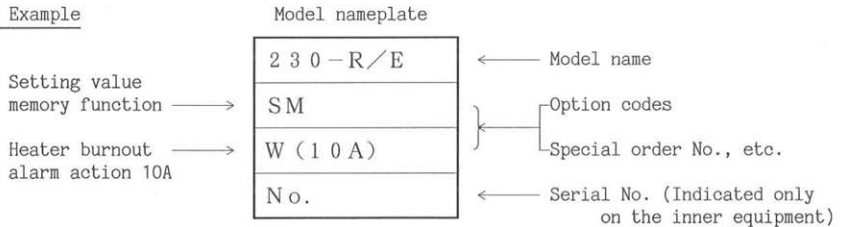

- Notes:
- Designation is required to apply the temperature alarm.
 - When applying the standby function, designate the option.

2. Name and functions of the sections

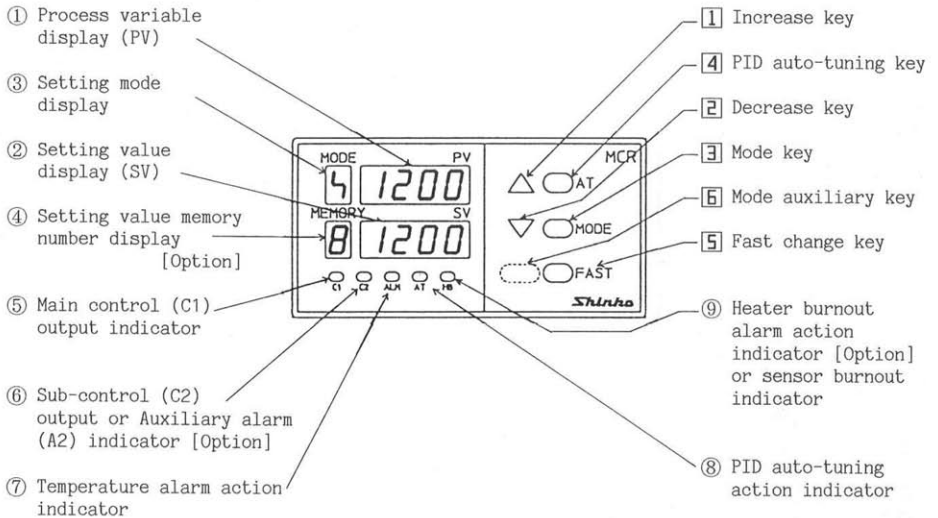





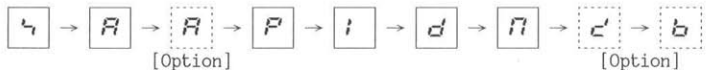





2.1 Explanations of display

- ① Process variable(PV) display Indicates the process variable with digital value. (red LED display)
- ② Setting value(SV) display Indicates the setting value with digital value. (green LED display)
- ③ Setting mode display Indicates the setting mode, and each pressing the "  MODE " key, the mode will change as follows. (yellow LED display)



- ④ Setting value memory number display [Option] Indicates setting value memory number being controlled. (red LED display)
- ⑤ Main control (C1) output ^{C1} indicator Green LED lights when the control output ON. (In case of current output, it always lights.)
- ⑥ Sub-control (C2) output ^{C2} or Temperature alarm (A2) output indicator [Option] Yellow LED lights when sub-control (C2) output or Temperature alarm (A2) output is ON.
- ⑦ Temperature alarm action ^{ALM} indicator Red LED lights when temperature alarm output ON.
- ⑧ PID auto-tuning action ^{AT} indicator Yellow LED blinks when PID auto-tuning performing.
- ⑨ Heater burnout alarm ^{HB} action indicator Red LED lights when heater burnout alarm output ON [Option] or Sensor burnout alarm output ON.

2.2 Explanations of keys

- 1  Increase key: Increases the setting value (SV) being displayed.
(When attached function setting mode is displayed, it works another function. See the explanation of each mode.)
When selected the setting value lock designating mode, the key selects the lock status 1 [*Loc 1*] or lock status 2 [*Loc 2*].
When selected the control mode designating mode, it selects the main control (C1) to heating (reverse) action status [*HEAT*].
- 2  Decrease key: Decreases the setting value (SV) being displayed.
(When attached function setting mode is displayed, it works another function. See the explanation of each mode.)
When selected the setting value lock designating mode, the key selects the lock status 1 [*Loc 1*] or unlock (lock cancelled) status [- -].
When selected the control mode designating mode, it selects the main control (C1) to cooling (direct) action status [*COOL*].
- 3  Mode key: Selects the mode: Main setting,
Temperature alarm setting,
[Auxiliary temperature alarm setting],
Proportional band setting,
Integral time setting,
Derivative time setting,
ARW setting,
[Dead band setting],
[Heater burnout alarm setting]
- 4  PID auto-tuning key: Performs or cancels the PID auto-tuning.
- 5  Fast change key: Makes the numeric value change fast by pressing this key while "  or  key" is being pressed.
- 6  Mode auxiliary key: If the "  MODE " key is pressed while this key is being pressed in the PV/SV display mode, the attached function setting mode is selected.
(In this attached function setting mode, the mode will change with only the "  MODE " key as follows:
Setting value lock designation →
Main control (C1) proportional cycle setting →
[Sub-control (C2) proportional cycle setting] →
[Sub-control (C2) proportional band setting] →
Main control (C1) differential setting →
[Sub-control (C2) differential setting] →
Scaling high limit setting → Scaling low limit setting →
Output high limit setting → Output low limit setting →
Sensor correction setting → Control type designation.)

Note: [] indicates option, however, as to temperature alarm setting, the option is to be applied only in case of with standby function.

3. Mounting to control panel

3.1 Site selection

Mount the controller in a place with:

- (1) A minimum of dust, and an absence of corrosive gases.
- (2) An ambient humidity is 85%RH or less, and non-condensing.
- (3) An ambient temperature is 0°C to 50°C, 32°F to 122°F.
- (4) No exposure to direct sunlight.
- (5) No mechanical vibrations or shocks.
- (6) The controller should be away from the electromagnetic switch of large capacity, or cables through which large current flows.
- (7) No water or oil and their vapor directly splash.

3.2 External dimension drawing

* When one-touch mounting bracket is used:
Mounting panel thickness 1 to 3 mm.

[Option]

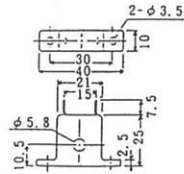
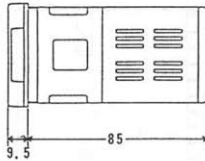
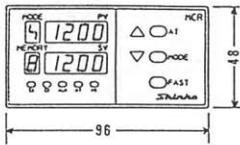

Current transformer for "Heater burnout alarm"

* When screw type mounting bracket is used:
Mounting panel thickness 1 to 8 mm.[Option:BL]

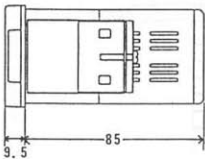
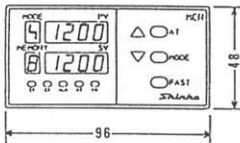

Notes:

- Do not screw with excessive force, or the case may be bent, since it is made of resin.
- Mount one-touch mounting bracket to the body in advance, and then insert MCR-200 from the front of panel.

3.3 Panel cutout

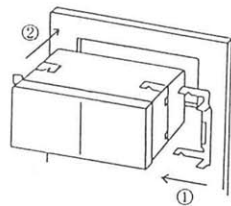
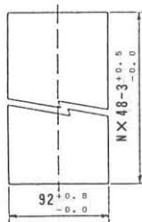
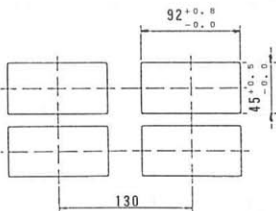

Vertical close mounting
n: Number of units mounted

4. Wiring connection

4.1 Terminal arrangements

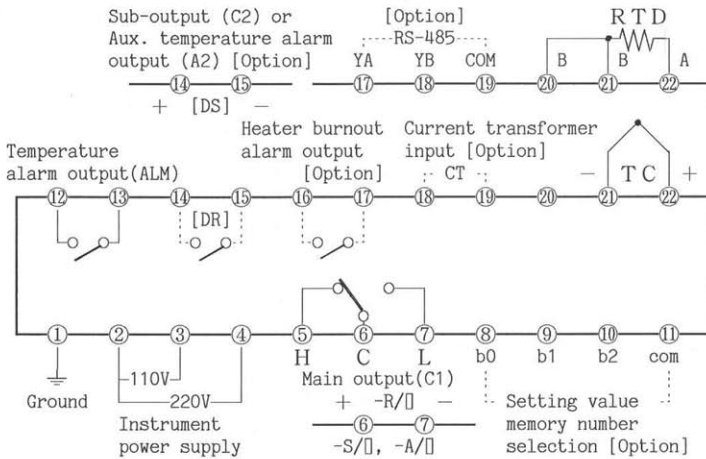

- Notes: 1. Dotted line shows the case option designated, if the option is not specified, the terminal is not equipped.
 2. Option [W] cannot be specified together with [C5] and vice versa.
 3. When specified option [C5], supply voltage 110V or 220V should be specified.
 4. Do not apply the voltage to the terminals between ③ and ④.

4.2 Wiring connection examples

MCR-230-R/E

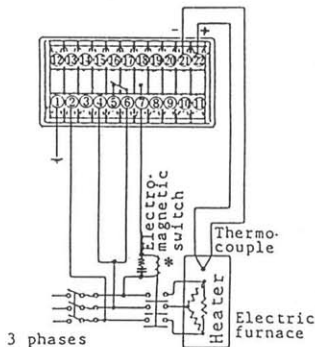

MCR-232-S/E

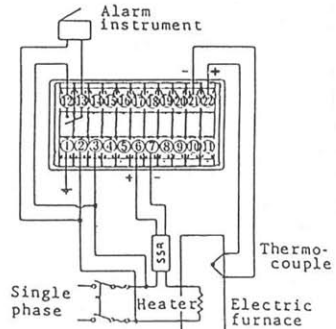

- Notes: * To prevent from a bad influence to the instrument owing to the unexpected level noise, it is recommended that the surge absorber be provided between the coil of the external relay.
 • The terminal block of this instrument is designed to wire from the below side. Lead wire must be inserted from the below side of the terminal.

Warning

Turn the power supplied to the instrument off before wiring or checking done. If working or touching the terminal with the power on status, there is a possibility of Electric Shock which can cause severe injury or death. Moreover, the instrument must be grounded before the power supplied to the instrument is turned on.

**** Notices ****

- ① Use a thermocouple and compensating lead wire applicable to the input specifications (K, J, etc.) of this controller.
- ② Use a 3-wire system of RTD applicable to the input specifications (Pt100) of this controller.
- ③ Check the specified voltage indicated on the voltage nameplate. This controller has no built-in power switch nor fuse. It is therefore recommended to provide them in the circuit near the external controller.
- ④ When wiring, keep input wire (Thermocouple, RTD, etc.) away from AC source and load wire to avoid external interference.
- ⑤ With relay output type of controller, it is recommended to provide auxiliary relay to protect the built-in relay contact, even if the load capacity is smaller than the built-in contact capacity (considering rush current).

[Option W: Heater burnout alarm function]

- ⑥ When using Current transformer (CT), select an accessory one.
- ⑦ Pass a lead wire of heater circuit into the hole of the CT.
- ⑧ This alarm is not available for detecting current under phase control.
- ⑨ When wiring, keep CT wire away from AC source and load wire.

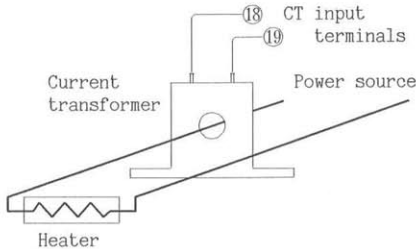

[Option SM: Setting value memory function]

To select the setting value memory number, use convenient switch "Model: MS-108", sold separately. (See page 21 for the detail)

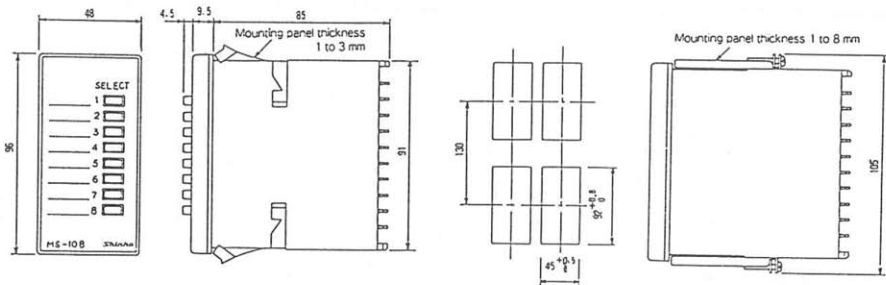

5. Operations

5.1 Basic operation (Basic function setting mode)

Process variable display (PV) indicates [$\bar{r}\bar{e}$ -] for approx. 6 seconds after the power turned ON. During this time, all outputs, digital displays and LED indicators are in their off status. (Meanwhile, avoid key operations, and do not turn the power supply ON while the key is operated.) After that, it displays actual temperature on the PV display, setting value on the SV display and starts control.

To select basic function setting mode, press the "MODE" key in PV/SV display mode. Then displays [\bar{r}] on setting mode display, and main setting mode is selected. In this mode, set the desired temperature for control by increasing or decreasing the numeric of setting value display with the " $\bar{\Delta}$ " or " $\bar{\nabla}$ " key. Moreover when using the " $\bar{\Delta}$ " or " $\bar{\nabla}$ " key, if the "FAST" key is simultaneously pressed, the change of numeric value becomes faster. Further, each pressing the "MODE" key, the mode is selected as shown below figure, and the setting values necessary for each mode are settable.

