

LIMITER SAAL (DC CURRENT) LIMITER SAVL (DC VOLTAGE)

INSTRUCTION MANUAL

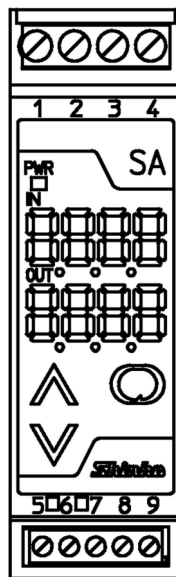

Shinbo

Preface

Thank you for purchasing the Limiter SAAL (DC current) and SAVL (DC voltage).

This manual contains instructions for the mounting, functions, operations and notes when operating the SAAL or SAVL. To prevent accidents arising from the misuse of this instrument, please ensure the operator receives this manual.

Notes

- This instrument should be used in accordance with the specifications described in the manual. If it is not used according to the specifications, it may malfunction or cause a fire.
- Be sure to follow the warnings, cautions and notices. If they are not observed, serious injury or malfunction may occur.
- Specifications of the SAAL and SAVL and the contents of this instruction manual are subject to change without notice.
- Care has been taken to ensure that the contents of this instruction manual are correct, but if there are any doubts, mistakes or questions, please inform our sales department.
- This instrument is designed to be installed on a DIN rail. If it is not, measures must be taken to ensure that the operator does not touch power terminals or other high voltage sections.
- Any unauthorized transfer or copying of this document, in part or in whole, is prohibited.
- Shinko Technos CO., LTD. is not liable for any damage or secondary damage(s) incurred as a result of using this product, including any indirect damage.

SAFETY PRECAUTIONS (Be sure to read these precautions before using our products.)

The safety precautions are classified into categories: "Warning" and "Caution".

Depending on circumstances, procedures indicated by  Caution may cause serious results, so be sure to follow the directions for usage.



Warning

Procedures which may lead to dangerous conditions and cause death or serious injury, if not carried out properly.



Caution

Procedures which may lead to dangerous conditions and cause superficial to medium injury or physical damage or may degrade or damage the product, if not carried out properly.



Warning

- To prevent an electric shock or fire, only Shinko or other qualified service personnel may handle the inner assembly.
- To prevent an electric shock, fire or damage to the instrument, parts replacement may only be undertaken by Shinko or other qualified service personnel.



Safety precautions

- To ensure safe and correct use, thoroughly read and understand this manual before using this instrument.
- This instrument is intended to be used for industrial machinery, machine tools and measuring equipment. Verify correct usage after consulting purpose of use with our agency or main office. (Never use this instrument for medical purposes with which human lives are involved.)
- External protection devices such as protection equipment against excessive temperature rise, etc. must be installed, as malfunction of this product could result in serious damage to the system or injury to personnel. Also proper periodic maintenance is required.
- This instrument must be used under the conditions and environment described in this manual. Shinko Technos Co., Ltd. does not accept liability for any injury, loss of life or damage occurring due to the instrument being used under conditions not otherwise stated in this manual.

Caution with respect to Export Trade Control Ordinance

To avoid this instrument from being used as a component in, or as being utilized in the manufacture of weapons of mass destruction (i.e. military applications, military equipment, etc.), please investigate the end users and the final use of this instrument.

In the case of resale, ensure that this instrument is not illegally exported.

1. Installation precautions



Caution

This instrument is intended to be used under the following environmental conditions (IEC61010-1): Overvoltage category II, Pollution degree 2

Ensure the mounting location corresponds to the following conditions:

- A minimum of dust, and an absence of corrosive gases
- No flammable, explosive gases
- No mechanical vibrations or shocks
- No exposure to direct sunlight, an ambient temperature of -5 to 55°C (23 to 131°F) that does not change rapidly, and no icing
- An ambient non-condensing humidity of 35 to 85%RH
- No large capacity electromagnetic switches or cables through which large current is flowing
- No water, oil or chemicals or where the vapors of these substances can come into direct contact with the unit
- When installing this unit within a control panel, take note that ambient temperature of this unit must not exceed 55°C (131°F). Otherwise the life of electronic components (especially electrolytic capacitor) may be shortened.

Note: Avoid setting this instrument directly on or near flammable material even though the case of this instrument is made of flame-resistant resin.

2. Wiring precautions



Caution

- Do not leave bits of wire in the instrument, because they could cause fire and malfunction.
- When wiring terminals, use ferrules with an insulation sleeve and crimping pliers made by Phoenix Contact GMBH & CO. applicable to terminals.
- Tighten the terminal screw using the specified torque.
If excessive force is applied to the screw when tightening, the screw or case may be damaged.
- This instrument has no built-in power switch, circuit breaker or fuse. It is necessary to install them near the instrument.
(Recommended fuse: Time-lag fuse, rated voltage 250V AC, rated current 2A)
- For wiring of AC power source, be sure to use exclusive terminals as described in this manual. If AC power source is connected to incorrect terminals, the unit will burn out.
- For a 24V DC power source, do not confuse polarity when wiring.
- For DC voltage and current input, do not confuse polarity when wiring.
- Keep the input wire, power line and output wire away from one another.

3. Operation and maintenance precautions



Caution

- Do not touch live terminals. This may cause electric shock or problems in operation.
- Turn the power supply to the instrument OFF when retightening the terminal and cleaning. Working or touching the terminal with the power switched ON may result in severe injury or death due to Electric Shock.
- Use a soft, dry cloth when cleaning the instrument.
(Alcohol based substances may tarnish or deface the unit.)
- As the display section is vulnerable, do not strike or scratch it with a hard object or press hard on it.

Characters used in this manual

Indication	-	0	1	2	3	4	5	6	7	8	9	℃	℉
Number, °C/℉	-1	0	1	2	3	4	5	6	7	8	9	℃	℉
Indication	A	B	C	D	E	F	G	H	I	J	K	L	M
Alphabet	A	B	C	D	E	F	G	H	I	J	K	L	M
Indication	N	O	P	Q	R	S	T	U	V	W	X	Y	Z
Alphabet	N	O	P	Q	R	S	T	U	V	W	X	Y	Z

□ means that no character is indicated (unlit) on the display.

--- CONTENTS ---

1. Model	Page
1.1 Model -----	5
1.2 How to read the model label -----	5
2. Name and functions of sections -----	5
3. Mounting	
3.1 External dimensions (Scale: mm) -----	6
3.2 Mounting and removal to/from the DIN rail -----	6
4. Wiring	
4.1 Recommended ferrules -----	7
4.2 Terminal arrangement and circuit configuration -----	8
4.3 Wiring of terminals -----	8
4.3.1 Power source wiring -----	8
4.3.2 Output wiring -----	8
4.3.3 Input wiring -----	8
5. Operation flowchart -----	9
6. Setup	
6.1 Indication after power ON -----	10
6.2 Basic operation of setup -----	11
6.3 Setup of the unit -----	12
7. Adjustment	
7.1 Basic operation of adjustment -----	14
7.2 Adjustment -----	14
8. Operation	
8.1 Indication after power-on -----	15
8.2 Operation -----	16
8.2.1 When using this unit as a signal conditioner -----	16
8.2.2 When using the Reverse function -----	16
8.2.3 When using the 1st order lag filter function -----	16
8.2.4 Output limit function -----	17
9. Specifications -----	17
10. Troubleshooting	
10.1 Indication -----	19
10.2 Key operation -----	19
10.3 Operation -----	19
11. Character table -----	20

1. Model

1.1 Model

SA <input type="checkbox"/> L - <input type="checkbox"/>		Series name: SA
Signal conditioner	A	DC current limiter
	V	DC voltage limiter
Power supply	0	100 to 240V AC
	1	24V AC/DC

(e.g.) SAAL-0 (DC current limiter), Supply voltage: 100 to 240V AC.

Default: Input : 4 to 20mA DC

Output: 4 to 20mA DC

SAVL-0 (DC voltage limiter), Supply voltage: 100 to 240V AC.

Default: Input : 1 to 5V DC

Output: 4 to 20mA DC

1.2 How to read the model label

The model label is attached to the left side of the case.

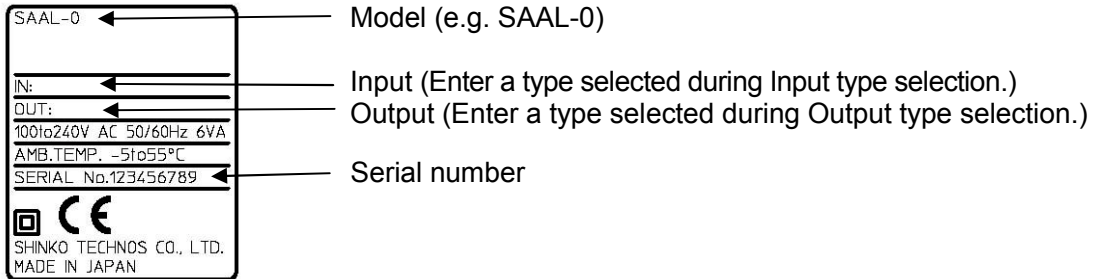

(Fig. 1.2-1)

2. Name and functions of sections

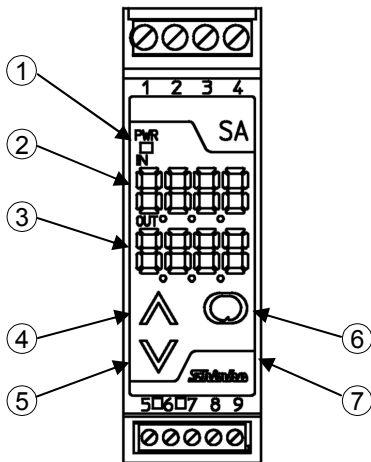

(Fig.2.1)

① Power indicator (Green)

Lights when the power to the instrument is turned on.

② Input display (Red)

Indicates the input value during Run mode.

Indicates setting (or adjustment) characters in the Setup and Adjustment mode.

③ Output display (Green)

Indicates the output value (%) during Run mode.

Indicates the set (or adjusted) value in the Setup, and Adjustment mode.

④ Up key (Λ)

Increases the numeric value, or switches the selection items.

⑤ Down key (∇)

Decreases the numeric value, or switches the selection items.

⑥ Mode key (⊙)

Switches the setting mode, and registers the set (or selected) value.

By holding down this key for approx. 3 seconds, the unit proceeds to the Adjustment mode.

⑦ Sub-mode key (Unmarked)

If the Mode key is pressed while holding down this key, the unit proceeds to the Setup mode.

3. Mounting

3.1 External dimensions (Scale: mm)

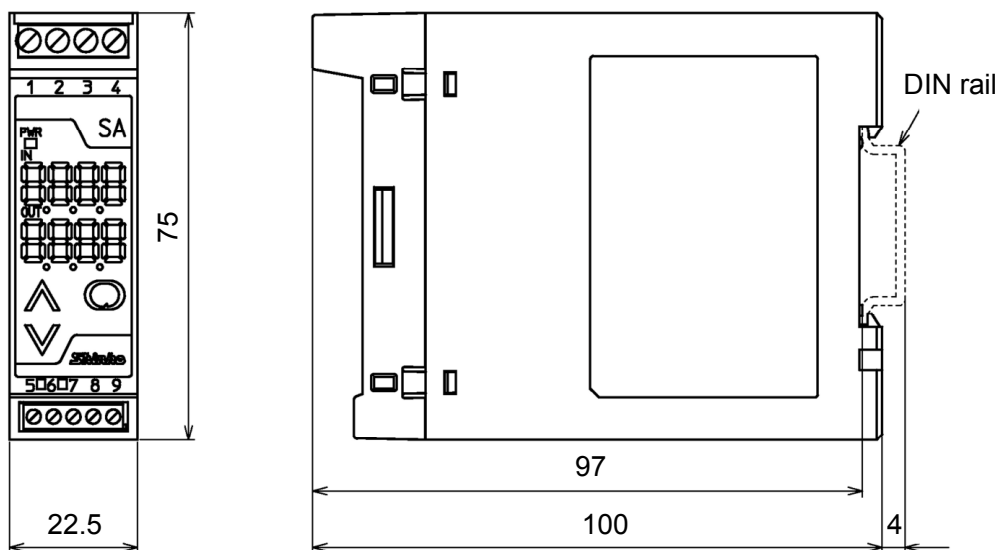

(Fig. 3.1-1)

3.2 Mounting and removal to/from the DIN rail



Caution

- Mount the DIN rail horizontally.
- To remove this instrument, a flat blade screwdriver is required for pulling down the lever.
Never turn the screwdriver when inserting it into the release lever.
If excessive power is applied to the lever, it may break.
- Be sure to use commercially available fastening plates at both ends of the unit if it is in a position susceptible to vibration or shock.

Recommended fastening plate

Manufacturer	Model
Omron Corporation	End plate PFP-M
IDEC Corporation	Fastening plate BNL6
Panasonic Electric Works Co., Ltd.	Fastening plate ATA4806

Mounting to the DIN rail (Fig. 3.2-1)

- Hook ① of the instrument on the upper side of the DIN rail.
- Making ① part of the instrument as a support, fit the lower part ② of the instrument to the DIN rail.
The unit will be completely fixed to the DIN rail when a “Click” sound is heard.

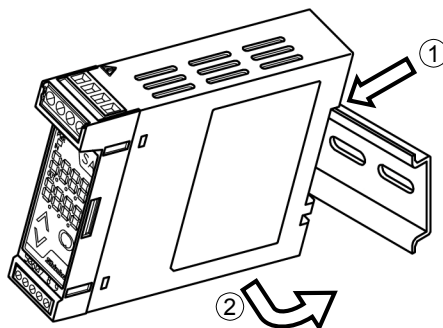

(Fig. 3.2-1)

Removal from the DIN rail (Fig.3.2-2)

- Insert a flat blade screwdriver into the release lever (①).
- Remove the instrument from the DIN rail by pulling down the lever (②).

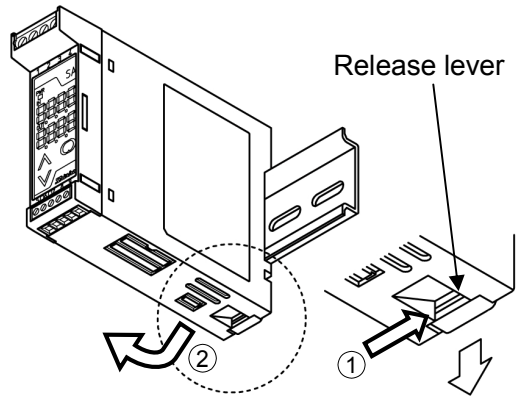

(Fig. 3.2-2)

4. Wiring

Warning

Turn the power supply to the instrument off before wiring.

Working or touching the terminal with the power switched on may result in severe injury or death due to Electric Shock.

Caution

- For 100 to 240V AC, if the AC power source is connected to incorrect terminals, this instrument will burn out.
- For a 24V DC power source, do not confuse polarity when wiring.

4.1 Recommended ferrules

When using ferrules, use the following recommended ferrules and crimping pliers made by Phoenix Contact GMBH &CO. See (Table 4.1-1).

Take note that screw size and tightening torque differ depending on the terminal number.

(Table 4.1-1)

Terminal number	Terminal screw	Ferrules with insulation sleeve	Conductor cross sections	Tightening torque	Crimping pliers
1 to 4	M2.6	AI 0.25-8 YE	0.2 to 0.25mm ²	0.5 to 0.6N•m	CRIMPFOX ZA 3 CRIMPFOX UD 6
		AI 0.34-8 TQ	0.25 to 0.34mm ²		
		AI 0.5-8 WH	0.34 to 0.5mm ²		
		AI 0.75-8 GY	0.5 to 0.75mm ²		
		AI 1.0-8 RD	0.75 to 1.0mm ²		
5 to 9	M2.0	AI 1.5-8 BK	1.0 to 1.5mm ²	0.22 to 0.25N•m	
		AI 0.25-8 YE	0.2 to 0.25mm ²		
		AI 0.34-8 TQ	0.25 to 0.34mm ²		
		AI 0.5-8 WH	0.34 to 0.5mm ²		

4.2 Terminal arrangement and circuit configuration

SAAL

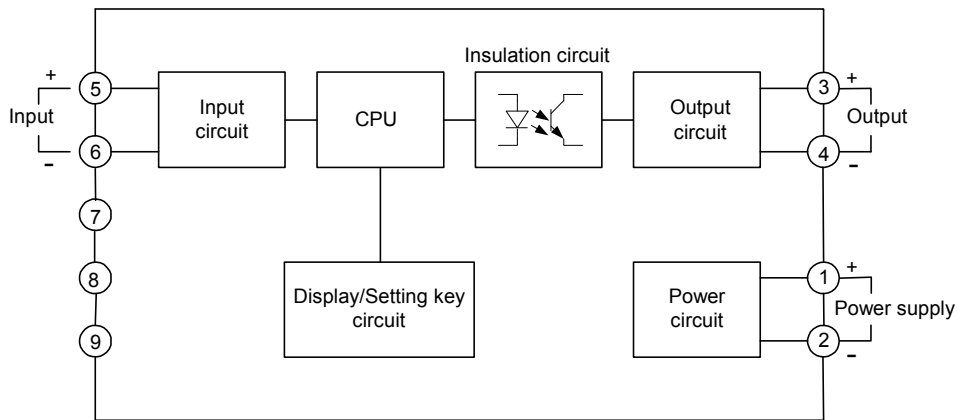

(Fig. 4.2-1)

SAVL

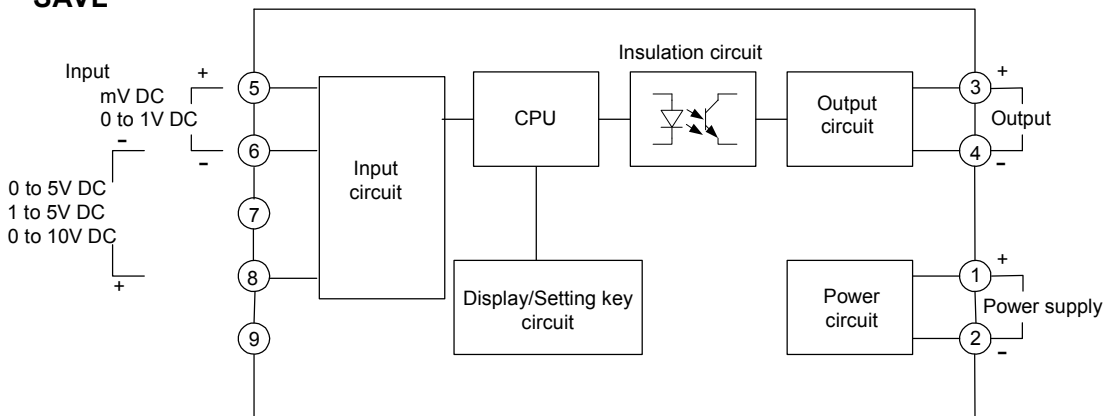

(Fig. 4.2-2)

4.3 Wiring of terminals

4.3.1 Power source wiring

Use terminals ①(+) and ②(-) for the power supply to the instrument.

4.3.2 Output wiring

Use terminals ③(+) and ④(-) for the output wiring.

4.3.3 Input wiring

SAAL (DC current limiter): Use terminals ⑤(+), ⑥(-) for input wiring and shunt resistor (sold separately) connection (Table 4.3.3-1).

SAVL (DC voltage limiter): Terminals for wiring differs depending on the input specifications. Refer to (Fig. 4.2-2).

(Table 4.3.3-1)

Input	Shunt resistor	
	Model	Specification
4 to 20mA DC, 0 to 20mA DC, 0 to 16mA DC	RES-S02-050	50Ω ±0.1%
2 to 10mA DC, 0 to 10mA DC	RES-S02-100	100Ω ±0.1%
1 to 5mA DC	RES-S02-200	200Ω ±0.1%
0 to 1mA DC	RES-S02-01K	1kΩ ±0.1%

5. Operation flowchart

Power ON

Warm-up indication (Approx. 3sec.)

Run mode

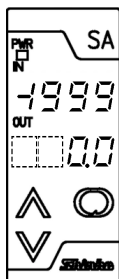

● **Input, Output display**

The Input display indicates setting (adjustment) characters, and the Output display indicates the default value.

● **Key operation**

- ↓ ○ : This means that if the ○ key is pressed, the set value is saved, and the instrument proceeds to the next setting item.
- Set the value with the ▲ or ▼ key, and register it with the ○ key.

Hold down the ○ key for approx. 3sec.

Adjustment mode

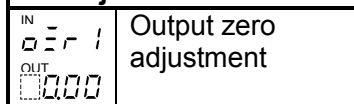

Press the ○ key.

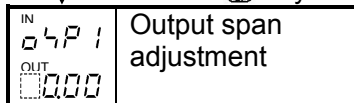

Press the ○ key.

• To return from Adjustment to Run mode, press the ○ key for approx. 3sec.
From any setting item in Adjustment mode, it is possible to return to Run mode.

Press the ○ key while holding down the Sub-mode key.

Setup mode

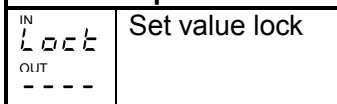

Press the ○ key.

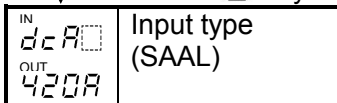

(SAVL)

Press the ○ key.

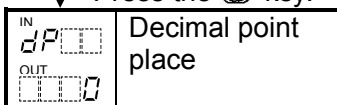

Press the ○ key.

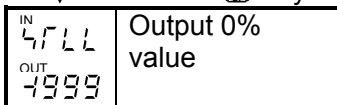

Press the ○ key.

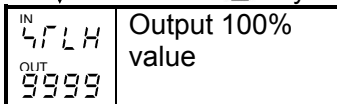

Press the ○ key.

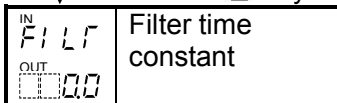

Press the ○ key.

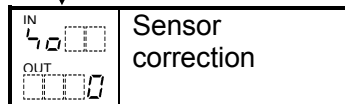

Press the ○ key.

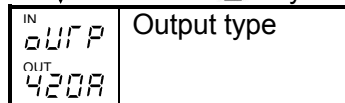

Press the ○ key.

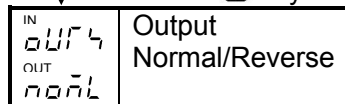

Press the ○ key.

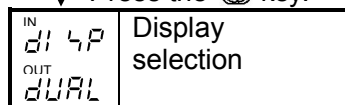

Press the ○ key.

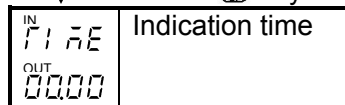

Press the ○ key.

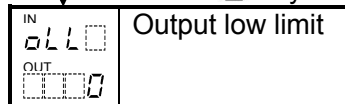

Press the ○ key.

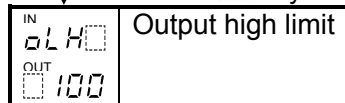

Press the ○ key.

6. Setup

Setup should occur before using this unit, to set the Input type, Output 0% value, Output 100% value, Output type, etc. according to the users' conditions.

If the users' specifications are the same as the default value of the instrument, or if setup has already been completed, it is not necessary to set up the instrument. Proceed to Section "7. Adjustment".

(Table 6-1)

Setting item	Default value
Set value lock	Unlock
Input type	SAAL 4 to 20mA DC (-1999 to 9999)
	SAVL 1 to 5V DC (-1999 to 9999)
Decimal point place	No decimal point
Output 0% value	-1999
Output 100% value	9999
Filter time constant	0.0 seconds
Sensor correction	0
Output type	4 to 20mA DC
Output Normal/Reverse	Normal
Display	Input/Output indication
Indication time	00.00 (Continuous)
Output low limit	0%
Output high limit	100%

6.1 Indication after power-on

After power-on, warm-up status below (Fig. 6.1-1) is indicated for approx. 3sec.

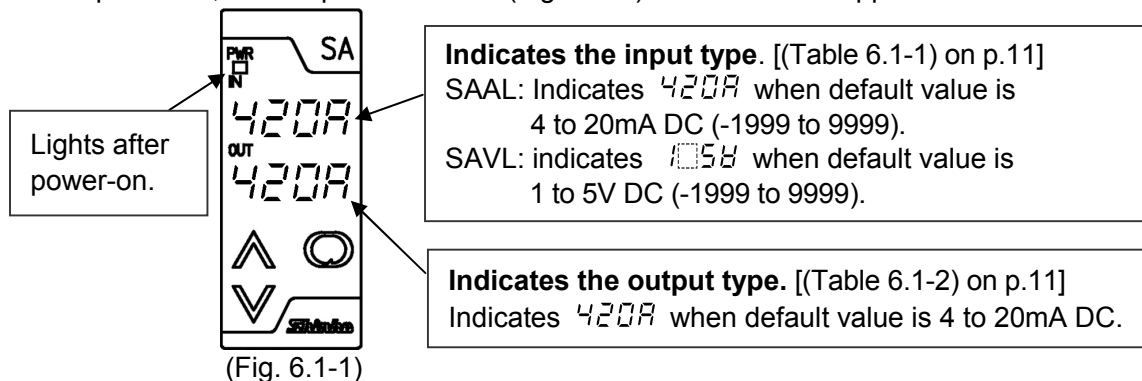

After that, the unit switches to the Run mode as shown below.

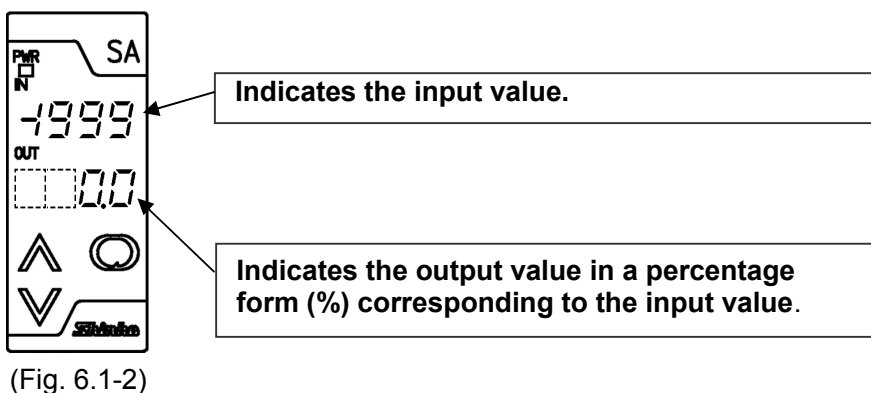

(Table 6.1-1)

Input	Input display
4 to 20mA DC	420A: -1999 to 9999
0 to 20mA DC	020A: -1999 to 9999
0 to 16mA DC	016A: -1999 to 9999
2 to 10mA DC	210A: -1999 to 9999
0 to 10mA DC	010A: -1999 to 9999
1 to 5mA DC	105A: -1999 to 9999
0 to 1mA DC	001A: -1999 to 9999
0 to 10mV DC	010V: -1999 to 9999
-10 to 10mV DC	-10V: -1999 to 9999
0 to 50mV DC	050V: -1999 to 9999
0 to 60mV DC	060V: -1999 to 9999
0 to 100mV DC	001V: -1999 to 9999
0 to 1V DC	001V: -1999 to 9999
0 to 5V DC	005V: -1999 to 9999
1 to 5V DC	105V: -1999 to 9999
0 to 10V DC	010V: -1999 to 9999



(Table 6.1-2)

Output	Output display
4 to 20mA DC	420A
0 to 20mA DC	020A
0 to 12mA DC	012A
0 to 10mA DC	010A
1 to 5mA DC	105A
0 to 1V DC	001V
0 to 5V DC	005V
1 to 5V DC	105V
0 to 10V DC	010V

6.2 Basic operation of setup

Setup is conducted in the Setup mode.

To enter the Setup mode, press the  key while holding down the Sub-mode key in the Run mode. (Fig. 6.2-1)

To set (select) each item, use the  or  key, and register the value with the  key. (Fig. 6.2-2)

(1) Run mode

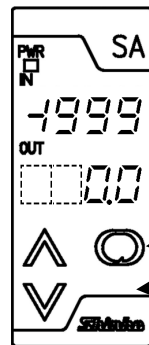

(Fig. 6.2-1)

To enter the Setup mode, press the Mode () key while holding down the Sub-mode key in the Run mode.

Mode key

Sub-mode key (Unmarked)

(2) Setup mode

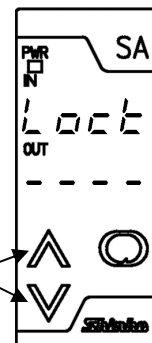

(Fig. 6.2-2)

To set (or select) each item, use these keys.

To proceed to each setting item and to register the set (or selected) value, please use this key.

6.3 Setup of the unit

The following shows all setup items. Set up the unit referring to the explanation of each item.





Display	Name, Function, Setting range	Default value
IN Loct OUT -----	Set value lock Locks the set values to prevent setting errors. Selection item: -----: Unlock Loct: Lock (None of the set values and adjusted values can be changed.)	Unlock
IN dcA OUT 420A	Input type (SAAL) Selects the input type. Selection item: 420A: 4 to 20mA DC -1999 to 9999 020A: 0 to 20mA DC -1999 to 9999 016A: 0 to 16mA DC -1999 to 9999 210A: 2 to 10mA DC -1999 to 9999 010A: 0 to 10mA DC -1999 to 9999 05A: 1 to 5mA DC -1999 to 9999 01A: 0 to 1mA DC -1999 to 9999	4 to 20mA DC, -1999 to 9999
IN dcV OUT 105V	Input type (SAVL) Selects the input type. Selection item: 012V: 0 to 10mV DC -1999 to 9999 -12V: -10 to 10mV DC -1999 to 9999 052V: 0 to 50mV DC -1999 to 9999 062V: 0 to 60mV DC -1999 to 9999 0012V: 0 to 100mV DC -1999 to 9999 012V: 0 to 1V DC -1999 to 9999 0052V: 0 to 5V DC -1999 to 9999 105V: 1 to 5V DC -1999 to 9999 0102V: 0 to 10V DC -1999 to 9999	1 to 5V DC, -1999 to 9999
IN dP OUT 0.000	Decimal point place Selects the decimal point place. Selection item: 0.000: No decimal point 0.00: 1 digit after decimal point 0.000: 2 digits after decimal point 0.0000: 3 digits after decimal point	No decimal point
IN 4FL OUT -9999	Output 0% value Sets the value (indicated on the Input display) at 0% output. Setting range: -1999 to Output 100% value (The placement of the decimal point follows the selection)	-1999
IN 4FL OUT 9999	Output 100% value Sets the value (indicated on the Input display) at 100% output. Setting range: Output 0% value to 9999 (The placement of the decimal point follows the selection)	9999
IN FIL OUT 0.00	Filter time constant Sets the filter time constant. Reduces input fluctuation caused by noise. Setting range: 0.0 to 10.0 seconds	0.0 seconds

IN 400 OUT 000	Sensor correction	0
Sets the sensor correction value. Input value = Current input value + Sensor correction value Setting range: -1000 to 1000 (The placement of the decimal point follows the selection)		
IN 000P OUT 420A	Output type	4 to 20mA DC
Selects the output type. Selection item: 420A: 4 to 20mA DC 020A: 0 to 20mA DC 012A: 0 to 12mA DC 010A: 0 to 10mA DC 05A: 1 to 5mA DC 01V: 0 to 1V DC 05V: 0 to 5V DC 15V: 1 to 5V DC 010V: 0 to 10V DC		
IN 000Y OUT nonL	Output Normal/Reverse	Normal
Selects either Normal mode (0.0 to 100.0%) or Reverse mode (100.0 to 0.0%) for output status. Selection item: nonL: Normal rEY: Reverse		
IN di 4P OUT dUAL	Display selection	Input/Output indication
Selects an indication type on the display. Selection item: dUAL: Input/Output indication i n: Input indication oUT: Output indication nonE: No indication (Only the power indicator is lit.)		
IN Ti nE OUT 0000	Indication time	00.00 (Continuous)
Sets the indication time of the display after the final key operation. Not available if No indication (Only the power indicator is lit) is selected during Display selection. After the indication time has elapsed, the displays go off (Only the power indicator is lit.). If power is turned on again, or if any of the keys \wedge , \vee , \odot and the Sub-mode key is pressed while displays are unlit, the displays will light again. Setting range: 00.00: Continuous indication 00.01 (1 second) to 60.00 (60 minutes) [Minute.Second]		
IN oLL0 OUT 0000	Output low limit	0%
Sets the output low limit value. Setting range: -5% to Output high limit value		
IN oLH0 OUT 0100	Output high limit	100%
Set the output high limit value. Setting range: Output low limit value to 105%		

7. Adjustment

Performs the output zero and span adjustments.
 Connect an mV generator to the input terminals of this instrument.
 Connect a digital multimeter to output terminals.

7.1 Basic operation of adjustment

Adjustment can be conducted in the Adjustment mode.
 To enter Adjustment mode, hold down the  key for approx. 3 seconds in the Run mode. (Fig. 7.1-1)
 For output adjustment, use the  or  key, and register the value with the  key. (Fig. 7.1-2)
 To revert to the Run mode, press the  key again for approximately 3 seconds.

(1) Run mode

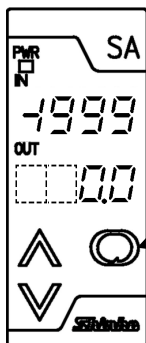

To enter Adjustment mode, please hold down the  key for approx. 3 seconds.

(Fig. 7.1-1)

(2) Adjustment mode

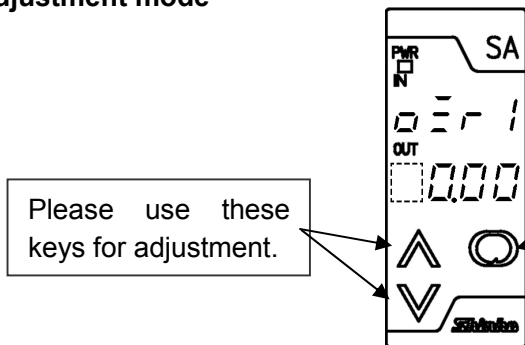



Please use these keys for adjustment.

To proceed to each item in the Adjustment mode and to register the adjusted value, please use this key.

(Fig. 7.1-2)

7.2 Adjustment

The following shows all adjustment items. Adjust values referring to explanation of each item below.

Display	Name, Function, Setting range	Default value
	Output zero adjustment Adjusts output zero. Input the value corresponding to 0% output, then adjust the value with the  or  key while viewing the output value (on the digital multimeter). When the output range lower limit is zero, (even if zero adjustment results in a negative value), the output value will not be negative. Setting range: -5.00 to 5.00% Effective range of adjustment differs depending on the output types.	0.00%
	4 to 20mA DC: -5 to 5% 0 to 1V DC : 0 to 5% 0 to 20mA DC: 0 to 5% 0 to 5V DC : 0 to 5% 0 to 12mA DC: 0 to 5% 1 to 5V DC : -5 to 5% 0 to 10mA DC: 0 to 5% 0 to 10V DC: 0 to 5% 1 to 5mA DC : -5 to 5%	

IN 04P1 OUT 000	Output span adjustment	0.00%
	Adjusts output span. Input the value corresponding to 100% output, then adjust the value with the \wedge or \vee key while viewing the output value (on the digital multimeter). Setting range: -5.00 to 5.00% Effective range of adjustment is 95 to 105%.	

8. Operation

8.1 Indication after power-on

After power-on, the following warm-up status is indicated for 3 seconds (Fig. 8.1-1).

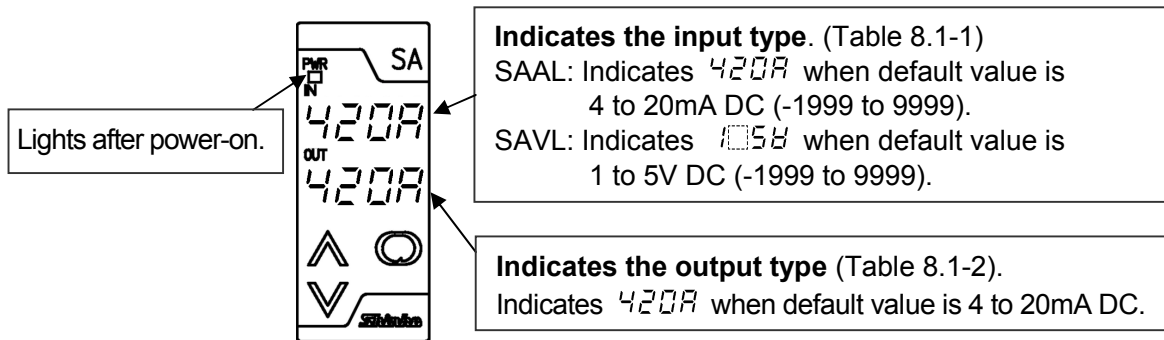

(Fig. 8.1-1)

(Table 8.1-1)

Input	Input display
4 to 20mA DC	420A: -1999 to 9999
0 to 20mA DC	020A: -1999 to 9999
0 to 16mA DC	016A: -1999 to 9999
2 to 10mA DC	210A: -1999 to 9999
0 to 10mA DC	010A: -1999 to 9999
1 to 5mA DC	1.5A: -1999 to 9999
0 to 1mA DC	0.1A: -1999 to 9999
0 to 10mV DC	0.1V: -1999 to 9999
-10 to 10mV DC	-1.1V: -1999 to 9999
0 to 50mV DC	0.5V: -1999 to 9999
0 to 60mV DC	0.6V: -1999 to 9999
0 to 100mV DC	0.1V: -1999 to 9999
0 to 1V DC	0.1V: -1999 to 9999
0 to 5V DC	0.5V: -1999 to 9999
1 to 5V DC	1.5V: -1999 to 9999
0 to 10V DC	0.1V: -1999 to 9999

(Table 8.1-2)

Output	Output display
4 to 20mA DC	420A
0 to 20mA DC	020A
0 to 12mA DC	012A
0 to 10mA DC	010A
1 to 5mA DC	1.5A
0 to 1V DC	0.1V
0 to 5V DC	0.5V
1 to 5V DC	1.5V
0 to 10V DC	0.1V

8.2 Operation

The unit enters the Run mode as shown in (Fig. 8.2-1). The input signal selected during Input type selection is converted to the output selected during Output type selection.

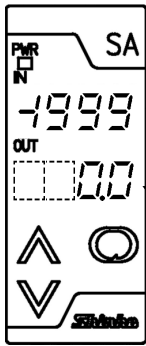

Indicates the input value.

Indicates the output value in a percentage form (%).

Output value corresponding to the input value is indicated in a percentage form (%).

(Fig. 8.2-1)

• Indication when input value is -2000 or less

For the indication of -2000 or less (up to -10% output), the input value and the minus (-) sign are indicated alternately.

(e.g.) Indication of -2000

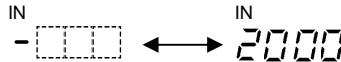

• Indication when input value is 10000 or more

For the indication of 10000 or more (up to 110% output), the lower 4 digits of input value are flashing.

(e.g.) Indication of 10020

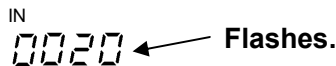

• Underrange, Overrange and Sensor burnout alarm indication

Even if any selection is made during the Display selection, the following indications appear.

Underrange : "-----" flashes on the Input display.

Overrange : "-----" flashes on the Input display.

• Indication time setting

If indication time is set, the displays will go off after the indication time has elapsed.

(Only the power indicator is lit.)

If power is turned on again, or if any of the keys \wedge , \vee , \odot and the Sub-mode key is pressed while displays are unlit, the displays will light again.

8.2.1 When using this unit as a standard limiter

Set the filter time constant to 0.0 seconds, and set the Output Normal/Reverse selection to "Normal".

8.2.2 When using the Reverse function

This function reverses the output (100 to 0%) that corresponds to the input (0 to 100%).

Set the Output Normal/Reverse selection to "Reverse".

8.2.3 When using the first order lag filter function

The value is outputted by performing the first order lag computation using the filter time constant "T". (Fig. 8.2.3-1)

Set the filter time constant to a random value (0.0 to 10.0 seconds).

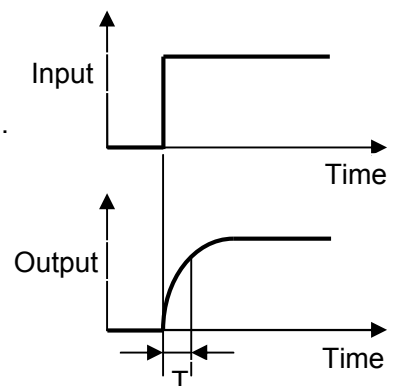

(Fig. 8.2.3-1)

8.2.4 Output limit function

Output limit function: -5 to 105% (Individual low limit, high limit setting)

Limits the minimum and maximum value of the converted output.

Set the output low and high limit value to a random value.

(e.g.) For 4 to 20mA, when output low limit value has been set to 10%, and output high limit value to 80%, the output low limit and high limit value will be as follows.

Output low limit value : $4\text{mA} + ((20-4)/100) \times 10 = 5.6\text{mA}$

Output high limit value : $4\text{mA} + ((20-4)/100) \times 80 = 16.8\text{mA}$

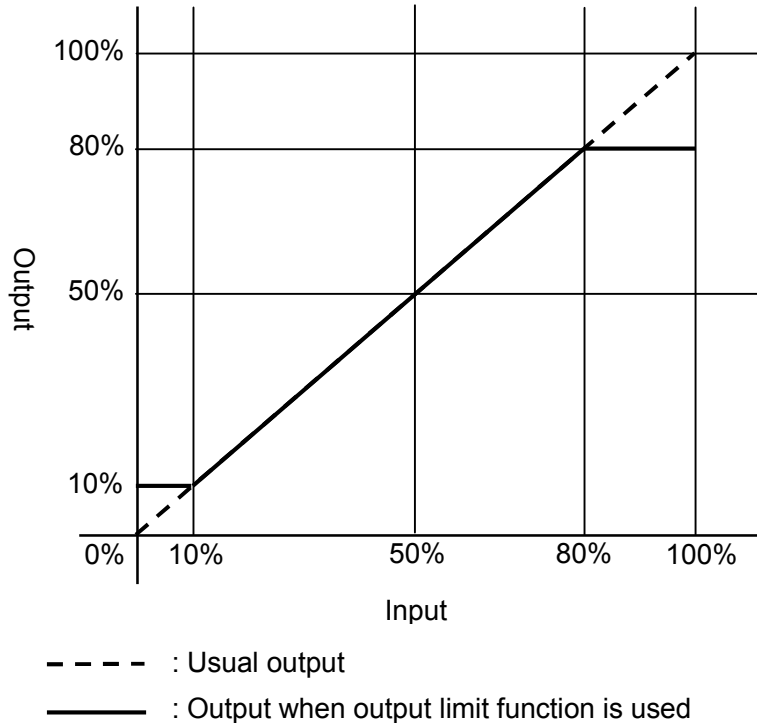

(Fig. 8.2.4-1)

9. Specifications

Input specifications

SAAL (DC current limiter)

Input	Shunt resistor
4 to 20mA DC	50Ω
0 to 20mA DC	
0 to 16mA DC	
2 to 10mA DC	100Ω
0 to 10mA DC	
1 to 5mA DC	200Ω
0 to 1mA DC	1kΩ

Connect a shunt resistor (sold separately) between input terminals.

See (Table 4.3.3-1) on page 8.

SAVL (DC voltage limiter)

Input	Input resistance	Allowable signal source resistance
0 to 10mV DC	1MΩ	20Ω or less
-10 to 10mV DC		40Ω or less
0 to 50mV DC		200Ω or less
0 to 60mV DC		
0 to 100mV DC		
0 to 1V DC		2kΩ or less
0 to 5V DC		1kΩ or less
1 to 5V DC		
0 to 10V DC		

Output specifications

DC current

Output	Allowable load resistance	Zero adjustment range	Span adjustment range
4 to 20mA DC	700Ω or less	-5 to 5%	95 to 105%
0 to 20mA DC	700Ω or less	0 to 5%	95 to 105%
0 to 12mA DC	1.2kΩ or less	0 to 5%	95 to 105%
0 to 10mA DC	1.2kΩ or less	0 to 5%	95 to 105%
1 to 5mA DC	2.4kΩ or less	-5 to 5%	95 to 105%

DC voltage

Output	Allowable load resistance	Zero adjustment range	Span adjustment range
0 to 1V DC	100Ω or more	0 to 5%	95 to 105%
0 to 5V DC	500Ω or more	0 to 5%	95 to 105%
1 to 5V DC	500Ω or more	-5 to 5%	95 to 105%
0 to 10V DC	1kΩ or more	0 to 5%	95 to 105%

When the output range lower limit is zero, (even if zero adjustment results in a negative value), the output value will not be negative.

Performance

Accuracy

Input : Within ±0.1%

Output: Within ±0.1%

Display accuracy

Within Input accuracy ± 1 digit

Response time

0.5 seconds (typical) (0 → 90%)

Temperature coefficient

±0.015%/°C

Insulation resistance

Input – Output – Power: 10MΩ or more, at 500V DC

Dielectric strength

Input – Output – Power: 2.0kV AC for 1 minute

General structure

Case

Flame-resistant resin, Color: Light gray

Front panel

Membrane sheet

Setting

Setting by the front keypad

Display, indicator

Input display : 7 segments Red LED display 4 digits
Character size: 7.4 x 4.0mm (H x W)

Output display : 7 segments Green LED display 4 digits
Character size: 7.4 x 4.0mm (H x W)

Power indicator: Green LED

Installation specifications

Power supply	100 to 240V AC 50/60Hz, 24V AC/DC 50/60Hz
Allowable voltage range	85 to 264V AC, 20 to 28V AC/DC
Power consumption	Approx. 6VA
Ambient temperature	-5 to 55°C (23 to 131°F)
Ambient humidity	35 to 85%RH (Non-condensing)
Weight	Approx. 120g
Mounting	DIN rail mounting
External dimensions	W22.5 x H75 x D100mm

Attached function

- **Power failure countermeasure:**

The setting data is backed up in the non-volatile IC memory.

- **Self-diagnosis:**

The CPU is monitored by a watchdog timer, and if an abnormal status is found on the CPU, the unit is switched to warm-up status with all outputs off.

10. Troubleshooting

10.1 Indication

Problem	Presumed cause and solution
Input display is flashing "----" or "- - - -".	<ul style="list-style-type: none">• The sensor may be burnt out. Change each sensor.• Check whether the sensor is securely connected to the input terminals of the instrument. Ensure that the sensor terminals are securely connected to the input terminals of the instrument.• Check the input signal source.
The indication of the Input display is irregular or unstable.	<ul style="list-style-type: none">• Check whether the sensor correcting value is suitable. Set it to a suitable value.• There may be equipment that interferes with or makes noise near the unit. Keep equipment that interferes with or makes noise away from the unit.

10.2 Key operation

Problem	Presumed cause and solution
Setting or adjustment is not possible.	<ul style="list-style-type: none">• "Lock" has been selected during Set value lock selection. Select "Unlock".

10.3 Operation

Problem	Presumed cause and solution
Input value does not change.	<ul style="list-style-type: none">• The sensor may be out of order. Change the sensor.• Check whether input and output wires are securely connected to the Input/Output terminals of the instrument. Ensure that input and output wires are securely connected to the Input/Output terminals.• Check whether the wiring of input and output is correct.
No output	<ul style="list-style-type: none">• Check whether Output 100% and Output 0% value have been set to suitable values.• Check whether Output type and Output Normal/Reverse have been selected correctly during Output type and Output Normal/Reverse selection.

11. Character table

All setting items are indicated in the following tables, however, some items will not be indicated depending on the specifications.

Setup mode

Display	Setting item	Default value	Data
<i>L o c k</i>	Set value lock	Unlock	
<i>d c P</i>	Input type (SAAL)	4 to 20mA DC (-1999 to 9999)	
<i>d c V</i>	Input type (SAVL)	1 to 5V DC (-1999 to 9999)	
<i>d P</i>	Decimal point place	No decimal point	
<i>4 F L L</i>	Output 0% value	-1999	
<i>4 F L H</i>	Output 100% value	9999	
<i>F I L T</i>	Filter time constant	0.0 seconds	
<i>4 a</i>	Sensor correction	0	
<i>o U T P</i>	Output type	4 to 20mA DC	
<i>o U T 4</i>	Output Normal/Reverse	Normal	
<i>d i s P</i>	Display selection	Input/Output indication	
<i>T I M E</i>	Indication time	00.00 (Continuous)	
<i>o L L</i>	Output low limit	0%	
<i>o L H</i>	Output high limit	100%	

Adjustment mode

Display	Setting item	Default value	Data
<i>o z e r o</i>	Output zero adjustment	0.00%	
<i>o s p a n</i>	Output span adjustment	0.00%	

***** Inquiry *****

For any inquiry about this unit, please contact the vendor where you purchased the unit or our agency after checking the following.

(e.g.)

- Model SA□L-□
- Serial number No. xxxxxx

In addition to the above, please let us know the details of malfunction, if any, and the operating conditions.

SHINKO TECHNOS CO.,LTD. OVERSEAS DIVISION

Reg. Office : 2-5-1, Senbahigashi, Minoo, Osaka, Japan

URL : <http://www.shinko-technos.co.jp>

E-mail : overseas@shinko-technos.co.jp

Tel : 81-72-727-6100

Fax: 81-72-727-7006