

# DIFFERENTIAL TRANSMITTER SGQ INSTRUCTION MANUAL



**Shinko**

# Preface

Thank you for purchasing our SGQ, Differential Transmitter. This manual contains instructions for the mounting, functions, operations and notes when operating the SGQ. To prevent accidents arising from the misuse of this instrument, please ensure the operator receives this manual.

## Notes

- This instrument should be used in accordance with the specifications described in the manual. If it is not used according to the specifications, it may malfunction or cause a fire.
- Be sure to follow the warnings, cautions and notices. If they are not observed, serious injury or malfunction may occur.
- The contents of this instruction manual are subject to change without notice.
- Care has been taken to ensure that the contents of this instruction manual are correct, but if there are any doubts, mistakes or questions, please inform our sales department.
- This instrument is designed to be installed on a DIN rail within a control panel. If it is not, measures must be taken to ensure that the operator does not touch power terminals or other high voltage sections.
- Any unauthorized transfer or copying of this document, in part or in whole, is prohibited.
- Shinko Technos Co., Ltd. is not liable for any damage or secondary damage(s) incurred as a result of using this product, including any indirect damage.

### **SAFETY PRECAUTIONS (Be sure to read these precautions before using our products.)**

The safety precautions are classified into categories: "Warning" and "Caution".

Depending on circumstances, procedures indicated by  Caution may result in serious consequences, so be sure to follow the directions for usage.



### **Warning**

Procedures which may lead to dangerous conditions and cause death or serious injury, if not carried out properly.



### **Caution**

Procedures which may lead to dangerous conditions and cause superficial to medium injury or physical damage or may degrade or damage the product, if not carried out properly.



### **Warning**

- To prevent an electrical shock or fire, only Shinko or qualified service personnel may handle the inner assembly.
- To prevent an electrical shock, fire, or damage to instrument, parts replacement may only be undertaken by Shinko or qualified service personnel.



### **Safety Precautions**

- To ensure safe and correct use, thoroughly read and understand this manual before using this instrument.
- This instrument is intended to be used for industrial machinery, machine tools and measuring equipment. Verify correct usage after purpose-of-use consultation with our agency or main office. (Never use this instrument for medical purposes with which human lives are involved.)
- External protection devices such as protective equipment against excessive temperature rise, etc. must be installed, as malfunction of this product could result in serious damage to the system or injury to personnel. Proper periodic maintenance is also required.
- This instrument must be used under the conditions and environment described in this manual. Shinko Technos Co., Ltd. does not accept liability for any injury, loss of life or damage occurring due to the instrument being used under conditions not otherwise stated in this manual.



### **Caution with Respect to Export Trade Control Ordinance**

To avoid this instrument from being used as a component in, or as being utilized in the manufacture of weapons of mass destruction (i.e. military applications, military equipment, etc.), please investigate the end users and the final use of this instrument. In the case of resale, ensure that this instrument is not illegally exported.

## ■ Installation Precautions



### Caution

This instrument is intended to be used under the following environmental conditions (IEC61010-1): Overvoltage category II, Pollution degree 2

Ensure the mounting location corresponds to the following conditions:

- A minimum of dust, and an absence of corrosive gases
- No flammable, explosive gases
- No mechanical vibrations or shocks
- No exposure to direct sunlight, an ambient temperature of -10 to 55°C (14 to 131°F) that does not change rapidly, and no icing
- An ambient non-condensing humidity of 35 to 85 %RH
- No large capacity electromagnetic switches or cables through which large current is flowing
- No water, oil, chemicals or the vapors of these substances can come into direct contact with the unit.
- When installing this unit within a control panel, please note that ambient temperature of this unit – not the ambient temperature of the control panel – must not exceed 55°C (131°F). Otherwise the life of electronic components (especially electrolytic capacitor) may be shortened.

**Note:** Avoid setting this instrument directly on or near flammable material even though the case of this instrument is made of flame-resistant resin.

## ■ Wiring Precautions



### Caution

- Do not leave bits of wire in the instrument, because they could cause a fire and malfunction.
- When wiring, use a crimping pliers and a solderless terminal with an insulation sleeve in which an M3 screw fits.
- Tighten the terminal screw using the specified torque. If excessive force is applied to the screw when tightening, the screw or case may be damaged.
- This instrument does not have a built-in power switch, circuit breaker and fuse. It is necessary to install a power switch, circuit breaker and fuse near the instrument. (Recommended fuse: Time-lag fuse, rated voltage 250 V AC, rated current 2 A)
- For wiring of the AC power source, be sure to use terminals as described in this manual. If the AC power source is connected to incorrect terminals, the unit will be burnt out.
- Do not apply a commercial power source to the sensor which is connected to the input terminal nor allow the power source to come into contact with the sensor.
- Use a thermocouple and compensating lead wire according to the sensor input specifications of this instrument.
- Use the 3-wire RTD according to the sensor input specifications of this instrument.
- When using DC voltage and current input, do not confuse polarity when wiring.
- Keep the input/output wires and power lines separate.

## ■ Operation and Maintenance Precautions



### Caution

- Do not touch live terminals. This may cause an electrical shock or problems in operation.
- Turn the power supply to the instrument OFF when retightening the terminal or cleaning. Working on or touching the terminal with the power switched ON may result in severe injury or death due to electrical shock.
- Use a soft, dry cloth when cleaning the instrument.  
(Alcohol based substances may tarnish or deface the unit.)
- As the display section is vulnerable, be careful not to put pressure on, scratch or strike it with a hard object.

## Characters used in this manual : No character is indicated (unlit).]

Indication	4	0	1	2	3	4	5	6	7	8	9	C	F
Number, °C/°F	-1	0	1	2	3	4	5	6	7	8	9	°C	°F
Indication	A	b	C	d	E	F	G	H	I	J	K	L	M
Alphabet	A	B	C	D	E	F	G	H	I	J	K	L	M
Indication	N	o	P	Q	R	S	T	U	V	W	X	Y	Z
Alphabet	N	O	P	Q	R	S	T	U	V	W	X	Y	Z

# Contents

	Page
1. Model .....	5
1.1 Model .....	5
1.2 How to Read the Model Label .....	6
2. Name and Functions .....	7
2.1 Front Panel .....	7
2.2 Display Section .....	8
3. Mounting .....	9
3.1 External Dimensions (Scale: mm) .....	9
3.2 Mounting to, and Removal from the DIN Rail .....	10
4. Wiring .....	11
4.1 Lead Wire Solderless Terminal .....	11
4.2 Circuit Configuration .....	11
4.3 Terminal Arrangement .....	12
4.4 Wiring .....	12
5. Display Mode .....	13
6. Setting Mode .....	16
6.1 Display Transition in Setting Mode .....	16
6.2 Input Setting Mode .....	18
6.3 Output Setting Mode .....	21
6.4 Math Function Setting Mode .....	24
6.5 Instrument Setting Mode .....	25
6.6 Custom Display Setting Mode .....	28
6.7 Manual Mode .....	28
7. Adjustment .....	29
7.1 Basic Operation of Adjustment .....	29
7.2 Adjustment .....	29
7.2.1 Output Adjustment .....	29
8. Operation .....	30
8.1 Indication after Power-on .....	30
8.2 Operation .....	30
8.2.1 Input Indication Range .....	30
8.2.2 Output Indication Range .....	30
8.2.3 Input Burnout Status .....	30
8.2.4 Indication Time Setting .....	30
8.2.5 Four Math Functions .....	31
9. Specifications .....	32
10. Troubleshooting .....	36
10.1 Indication .....	36
10.2 Key Operation .....	36
10.3 Operation .....	37
11. Character Table .....	38

# 1. Model

## 1.1 Model

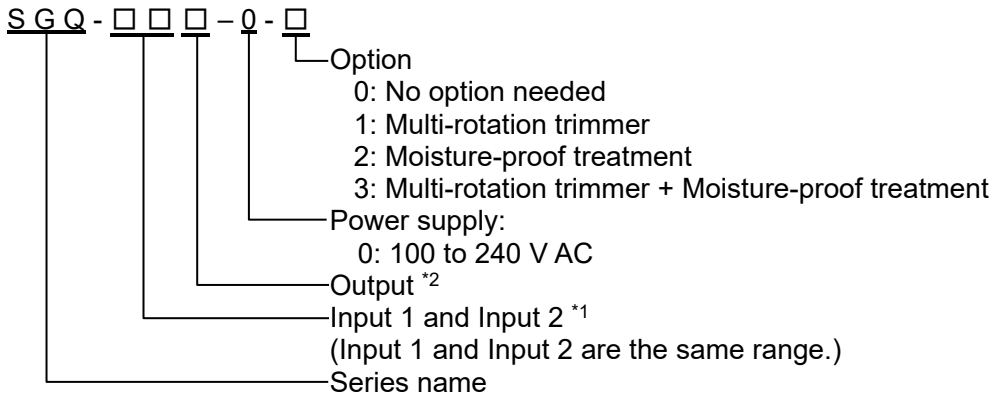

### \*1: Input 1, Input 2

Code	Input Type		Code	Input Type	
K0	K thermocouple	-200 to 1370 °C (-328 to 2498 °F)	T0	T thermocouple	-200 to 400 °C (-328 to 752 °F)
K1		-200 to 200 °C (-328 to 392 °F)	T1		-100 to 100 °C (-148 to 212 °F)
K2		0 to 400 °C (32 to 752 °F)	N	N thermocouple	-200 to 1300 °C (-328 to 2372 °F)
J0	J thermocouple	-200 to 1000 °C (-328 to 1832 °F)	PL	PL-II thermocouple	0 to 1390 °C (32 to 2534 °F)
J1		-200 to 200 °C (-328 to 392 °F)	W5	W5Re/W26Re thermocouple	0 to 2315 °C (32 to 4199 °F)
J2		0 to 400 °C (32 to 752 °F)	W3	W3Re/W25Re thermocouple	0 to 2315 °C (32 to 4199 °F)
R	R thermocouple	-50 to 1760 °C (-58 to 3200 °F)	P0	Pt100 RTD	-200 to 650 °C (-328 to 1202 °F)
S	S thermocouple	-50 to 1760 °C (-58 to 3200 °F)	P1		-100 to 100 °C (-148 to 212 °F)
B	B thermocouple	0 to 1820 °C (32 to 3308 °F)	P2	JPt100 RTD	-200 to 500 °C (-328 to 932 °F)
E	E thermocouple	-200 to 800 °C (-328 to 1472 °F)	P3		-100 to 100 °C (-148 to 212 °F)

### \*2: Output

Code	Output Type		Code	Output Type	
1	Current output	4 to 20 mA	A	Voltage output	0 to 10 mV
2		0 to 20 mA	B		0 to 100 mV
3		0 to 16 mA	C		0 to 1 V
4		2 to 10 mA	D		0 to 5 V
5		0 to 10 mA	E		1 to 5 V
			F		0 to 10 V
			G		-5 to 5 V

## 1.2 How to Read the Model Label

The model label is attached to the right side of the case.

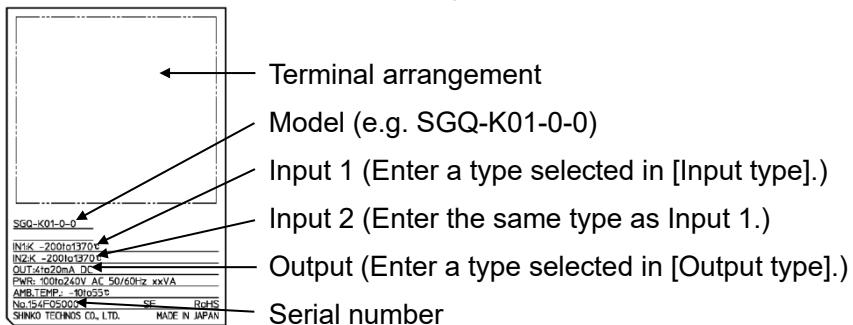

(Fig. 1.2-1)

## 2. Name and Functions

### 2.1 Front Panel

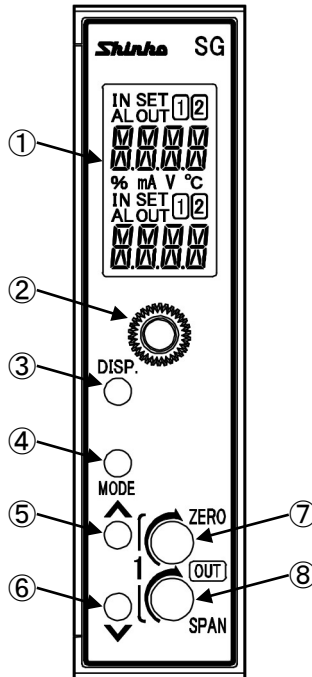

(Fig. 2.1-1)

①	<b>Display section</b>	Indicates setting contents, input value, output value, etc.
②	<b>Mounting screw</b>	Used for fixing the instrument to the socket or removal from it.
③	<b>DISP key</b>	Switches the displays, and moves to the next setting item. Releases the lock status of the DISP key by pressing for 3 seconds.
④	<b>MODE key</b>	Selects either a setting mode or a display mode. Shifts the digit for the Custom Display. Enters the setting mode by pressing and holding for 5 seconds.
⑤	<b>UP key</b>	Increases the numerical value. Contents of Multi-Display A and B can be changed alternately when Default Display is RUN display mode 1, 2, 3, 4, 5, 6 and 7.
⑥	<b>DOWN key</b>	Decreases the numerical value. Enters Manual mode by pressing for 3 seconds.
⑦	<b>Output Zero</b>	Adjusts the value of Output Zero.
⑧	<b>Output Span</b>	Adjusts the value of Output Span.

## 2.2 Display Section

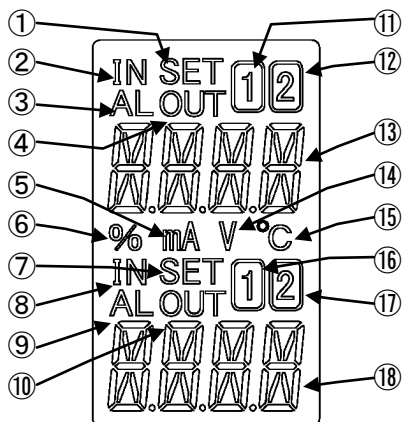

(Fig. 2.2-1)

①	<b>Setting display indicator A</b>	Lights up in Manual mode.
②	<b>Input indicator A</b>	Lights up when Multi-Display A indicates an input value or input math function value.
③	<b>Alarm indicator A</b>	Lights up if an input error or input burnout occurs while Multi-Display A indicates an input value.
④	<b>Output indicator A</b>	Lights up when Multi-Display A indicates an output value.
⑤	<b>mA indicator</b>	Lights up when mA is selected in [Indication unit].
⑥	<b>% indicator</b>	Lights up in Manual mode or when % is selected in [Indication unit].
⑦	<b>Setting display indicator B</b>	Lights up for the setting display.
⑧	<b>Input indicator B</b>	Lights up when Multi-Display B indicates an input value.
⑨	<b>Alarm indicator B</b>	Lights up if an input error or input burnout occurs while Multi-Display B indicates an input value.
⑩	<b>Output indicator B</b>	Lights up when Multi-Display B indicates an output value.
⑪	<b>1 indicator A</b>	Lights up in Manual mode or when Multi-Display A indicates Input 1, output value or input math function value.
⑫	<b>2 indicator A</b>	Lights up when Multi-Display A indicates Input 2 or input math function value.
⑬	<b>Multi-Display A</b>	Indicates the following in accordance with the display indication: Input value, output value, custom characters, setting item
⑭	<b>V indicator</b>	Lights up when V is selected in [Indication unit].
⑮	<b>°C indicator</b>	Lights up when °C is selected in [Indication unit].
⑯	<b>1 indicator B</b>	Lights up when Multi-Display B indicates Input 1 or output value.
⑰	<b>2 indicator B</b>	Lights up when Multi-Display B indicates Input 2.
⑱	<b>Multi-Display B</b>	Indicates the following in accordance with the display indication: Input value, output value, custom characters, setting value

**Output indicators A and B, Alarm indicators A and B: Red**  
**Other indicators: White**



# 3. Mounting

## 3.1 External Dimensions (Scale: mm)

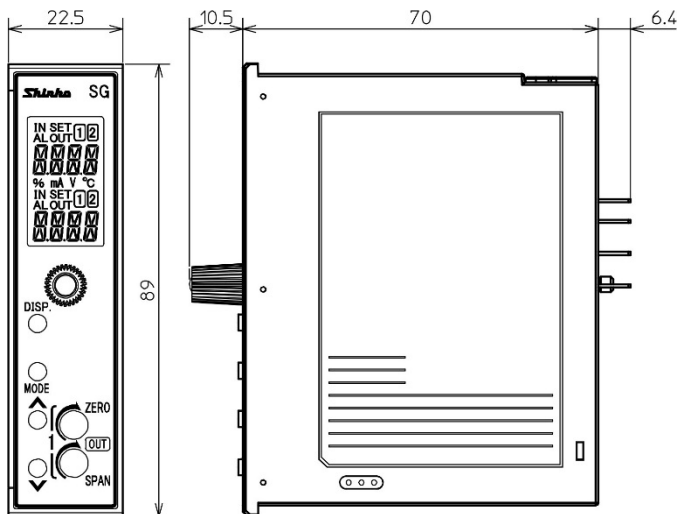

### 11P socket

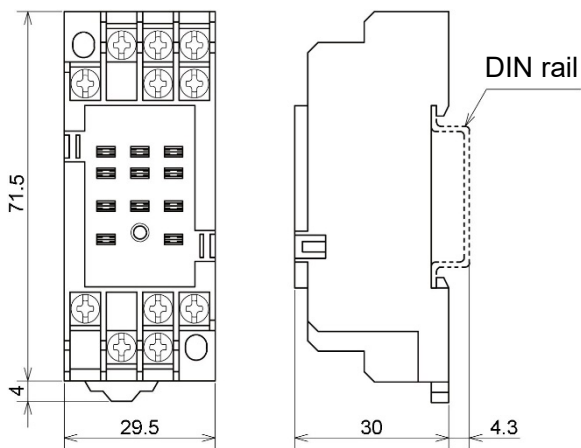

(Fig. 3.1-1)

### 3.2 Mounting to, and Removal from the DIN Rail



## Caution

- Mount the DIN rail horizontally.
- To remove the socket, a flat blade screwdriver is required.  
Never turn the screwdriver when inserting it into the Lock lever. If excessive power is applied to the lever, it may break.
- If the instrument is mounted in a position susceptible to vibration or shock, mount commercially available fastening plates at both ends of the instrument.

#### Recommended Fastening Plate

Manufacturer	Model
Omron Corporation	End plate PFP-M
IDEC Corporation	Fastening plate BNL6
Panasonic Electric Works Co., Ltd.	Fastening plate ATA4806

#### Mounting to the DIN rail (Fig. 3.2-1)

- ① Separate the instrument from the socket by loosening the mounting screw on the front panel.
- ② Make sure the lock lever of the socket is located in the lower part of the socket. Hook the upper side of the socket onto the DIN rail, then fit the lower part of the socket onto the DIN rail (A clicking sound should be heard when done properly.).



## Caution

- Before inserting the instrument to the socket, make sure the cable is wired properly. (Refer to “4. Wiring”.)
- When inserting or removing the socket, make sure the socket is oriented vertically. If force is applied in any other direction than vertically, a malfunction may occur.
- If the mounting screw is fastened too tightly, a malfunction may occur.

- ③ Insert the SGQ into the socket.
- ④ Fasten the mounting screw by turning it clockwise, to secure the SGQ onto the socket. Tighten the screw lightly.

#### Removal from the DIN rail (Fig. 3.2-2)

- ① Turn the power to the instrument OFF.
- ② Separate the instrument from the socket by loosening the mounting screw on the front panel.
- ③ Insert a flat blade screwdriver into the Lock lever (lower part of the socket), and remove the socket from the DIN rail while pulling the lever down.

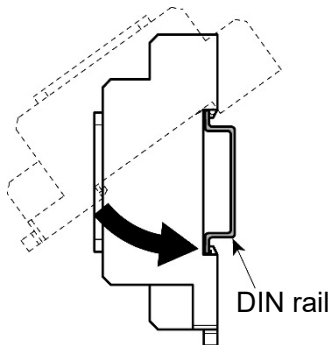

(Fig. 3.2-1)

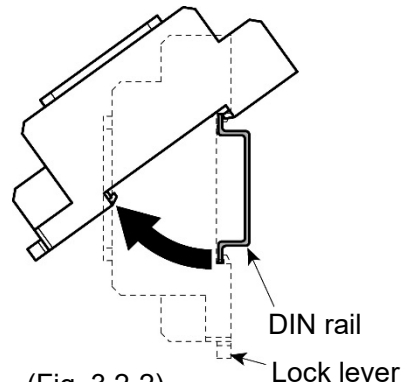

(Fig. 3.2-2)

# 4. Wiring



## Warning

Turn the power supply to the instrument off before wiring or checking. Working on or touching the terminal with the power switched on may result in severe injury or death due to electrical shock.

### 4.1 Lead Wire Solderless Terminal

Use a solderless terminal with an insulation sleeve in which an M3 screw fits as shown below. The torque should be 0.63 N·m.

Solderless Terminal	Manufacturer	Model
Y-type	Nichifu Terminal Industries Co., Ltd.	TMEV1.25Y-3
	Japan Solderless Terminal MFG Co., Ltd.	VD1.25-B3A
Ring-type	Nichifu Terminal Industries Co., Ltd.	TMEV1.25-3
	Japan Solderless Terminal MFG Co., Ltd.	V1.25-3

Y-type(Scale: mm)

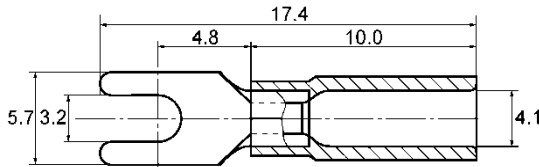

(Fig. 4.1-1)

Ring-type(Scale: mm)

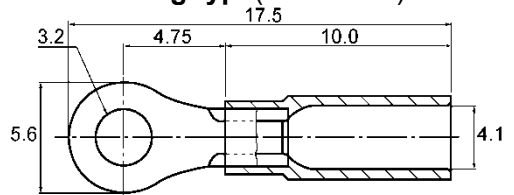

(Fig. 4.1-2)

### 4.2 Circuit Configuration

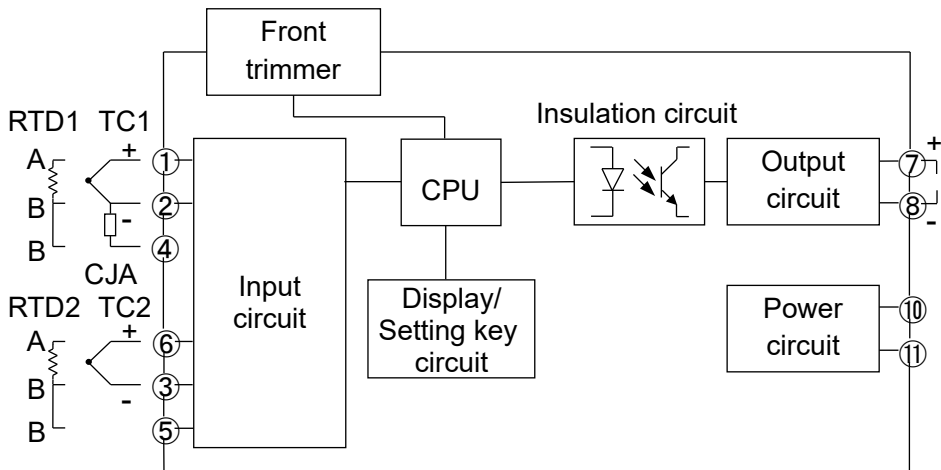

(Fig. 4.2-1)

### 4.3 Terminal Arrangement

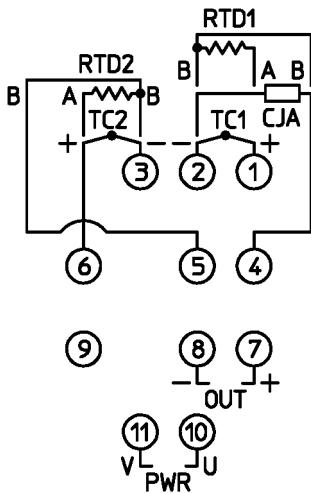

(Fig. 4.3-1)

PWR	Power supply voltage 100 to 240 V AC
OUT	Output
TC1, TC2	Thermocouple input
RTD1, RTD2	RTD input
CJA	Cold junction compensator input

### 4.4 Wiring



## Warning

- If the AC power source is connected to incorrect terminals, the instrument will be burnt out.

#### (1) Power Source Wiring

Use terminals ⑩, ⑪ for the power supply to the instrument.

#### (2) Output Wiring

Use terminals ⑦(+), ⑧(-) for the output wiring.

#### (3) Input Wiring

Input 1: Use terminals ①, ②, ④ for Input 1 wiring.

Input 2: Use terminals ⑥, ③, ⑤ for Input 2 wiring.

Connect the thermocouple CJA (Cold junction compensator) between terminals ② and ④.

# 5. Display Mode

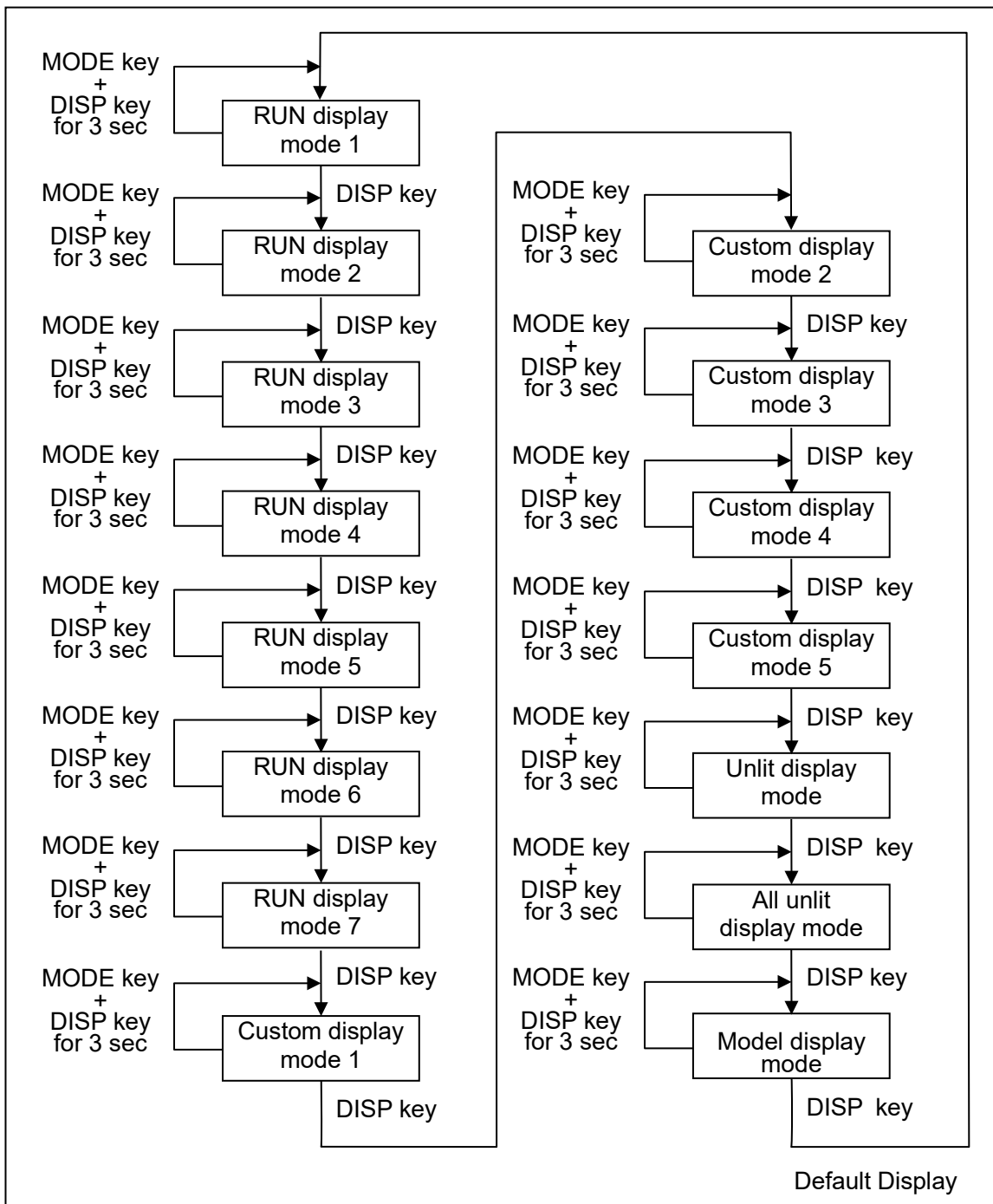

**Default Display:**

If the MODE and DISP keys (in that order) are pressed together for approx. 3 seconds in any display mode, the display mode will become the Default Display. Once the Default Display is set, the DISP key will be in lock status. If the DISP key is pressed for approx. 3 seconds on the Default

Display, the key lock status will be cancelled.

If the DISP key is pressed while the DISP key is in lock status, Multi-Display A indicates **LOCK**.

- RUN display mode 1:** Multi-Display A indicates Input 1 value, and Multi-Display B indicates the output value.  
Alarm indicator A and B light up respectively if they are under the conditions of lighting.
- RUN display mode 2:** Multi-Display A indicates Input 2 value, and Multi-Display B indicates the output value.  
Alarm indicator A and B light up respectively if they are under the conditions of lighting.
- RUN display mode 3:** Multi-Display A indicates Input 1 value, and Multi-Display B indicates Input 2 value.  
Alarm indicator A and B light up respectively if they are under the conditions of lighting.
- RUN display mode 4:** Multi-Display A indicates Input 1 value, and Multi-Display B is unlit.  
Alarm indicator A and B light up respectively if they are under the conditions of lighting.
- RUN display mode 5:** Multi-Display A indicates Input 2 value, and Multi-Display B is unlit.  
Alarm indicator A and B light up respectively if they are under the conditions of lighting.
- RUN display mode 6:** Multi-Display A is unlit, and Multi-Display B indicates the output value.  
Alarm indicator A and B light up respectively if they are under the conditions of lighting.
- RUN display mode 7:** Multi-Display A indicates the Input math function value, and Multi-Display B indicates the output value.  
Alarm indicator A and B light up respectively if they are under the conditions of lighting.
- Custom display mode 1:** Multi-Display A indicates characters set in [Multi-Display A].  
Multi-Display B indicates characters set in [Multi-Display B].  
Alarm indicator A lights up if it is under the conditions of lighting.

- Custom display mode 2:** Multi-Display A indicates Input 1 value, and Multi-Display B indicates characters set in [Multi-Display B].  
Alarm indicator A lights up if it is under the conditions of lighting.
- Custom display mode 3:** Multi-Display A indicates Input 2 value, and Multi-Display B indicates characters set in [Multi-Display B].  
Alarm indicator A lights up if it is under the conditions of lighting.
- Custom display mode 4:** Multi-Display A indicates the output value, and Multi-Display B indicates characters set in [Multi-Display B].  
Alarm indicator A lights up if it is under the conditions of lighting.
- Custom display mode 5:** Multi-Display A indicates Input math function value, and Multi-Display B indicates characters set in [Multi-Display B].  
Alarm indicator A lights up if it is under the conditions of lighting.
- Unlit display mode:** Multi-Display A and B are unlit, and the Input indicator A lights up.  
Alarm indicator A lights up if it is under the conditions of lighting.
- All unlit display mode:** All displays and indicators are unlit.  
Alarm indicator A and B do not light up even if they are under the conditions of lighting.
- Model display mode:** Multi-Display A indicates a model name, and Multi-Display B indicates the input code and output code.  
Alarm indicator A lights up if it is under the conditions of lighting.

# 6. Setting Mode

## 6.1 Display Transition in Setting Mode

- If the MODE key is pressed and held down for approx. 5 seconds in each setting mode, the unit will move to the Default Display.

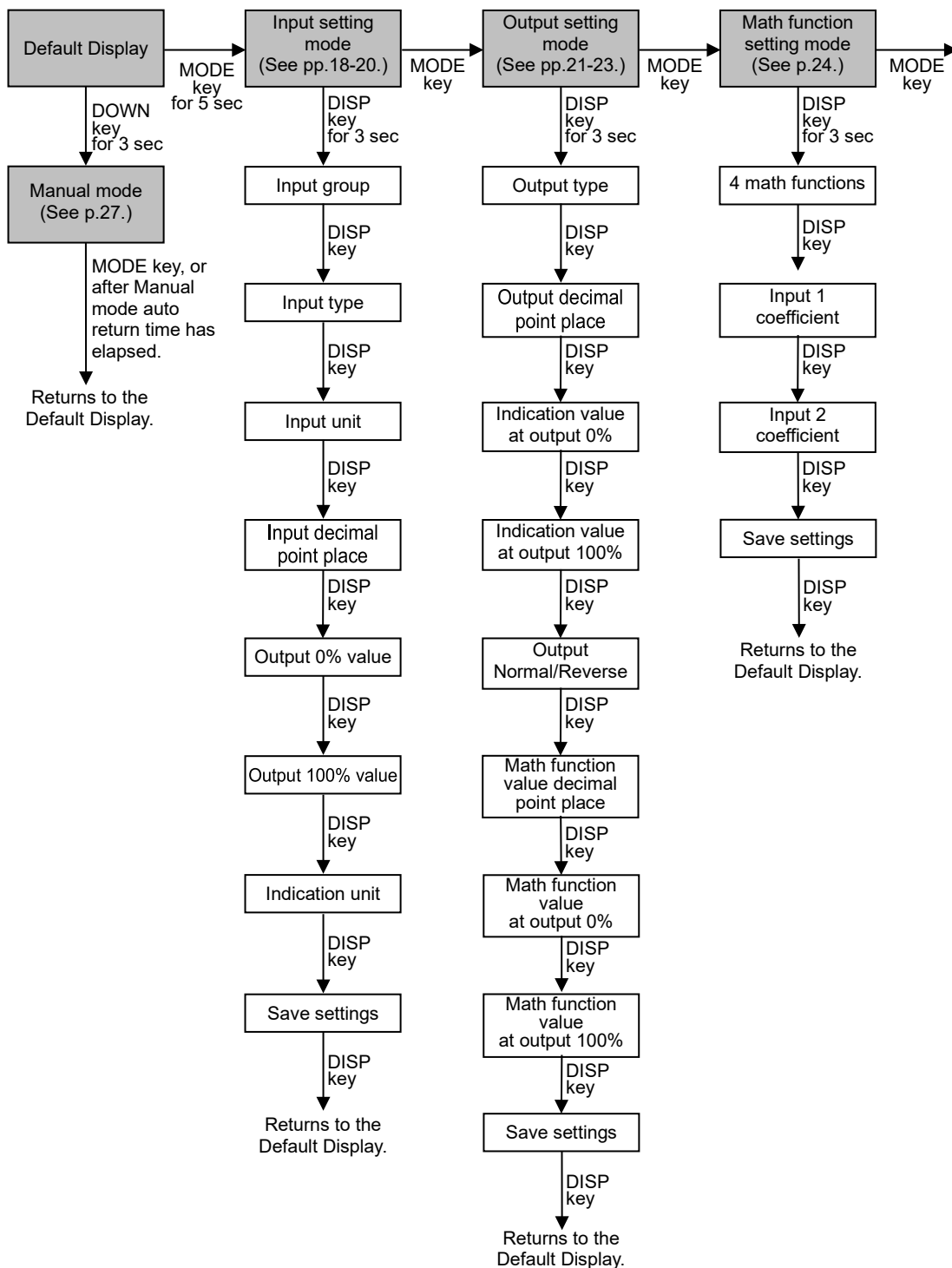



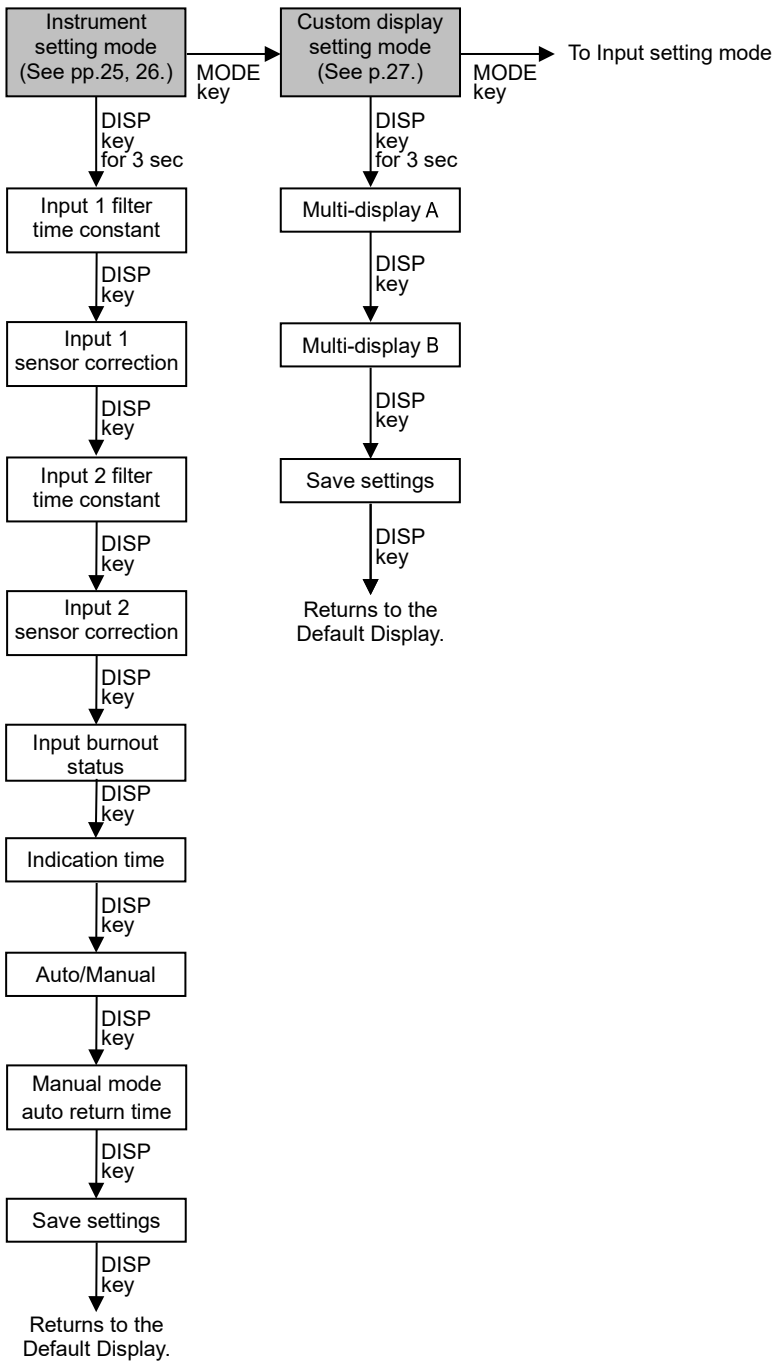

## 6.2 Input Setting Mode

### Input Group

Selects an input group.

Setting Range	Indication		Factory Default
	Multi-Display A	Multi-Display B	
Thermocouple input	SENG		Thermocouple input 
RTD input			

### Input Type

Selects an input type.

Setting Range	Indication		Factory Default
	Multi-Display A	Multi-Display B	
K -200 to 1370°C	SENG		K -200 to 1370 °C 
K -200 to 200°C *1, *2			
K 0 to 400°C *1			
J -200 to 1000°C			
J -200 to 200°C *1, *2			
J 0 to 400°C *1			
R -50 to 1760°C			
S -50 to 1760°C			
B 0 to 1820°C			
E -200 to 800°C			
T -200 to 400°C			
T -100 to 100°C *1			
N -200 to 1300°C			
PL-II 0 to 1300°C			
W5Re/W26Re 0 to 2315°C			
W3Re/W25Re 0 to 2315°C			
Pt100 -200 to 650°C	SENG		Pt100 -200 to 650 °C 
Pt100 -100 to 100°C *1			
JPt100 -200 to 500°C			
JPt100 -100 to 100°C *1			

\*1: Decimal point place can be selected.

[No decimal point] or [1 digit after decimal point] can be selected in [Input decimal point place].

\*2: If [1 digit after decimal point] is selected in [Input decimal point place], the input low limit value will be -199.9.

## Input Unit

Selects an input temperature unit °C or °F.

Setting Range	Indication		Factory Default
	Multi-Display A	Multi-Display B	
°C			°C 
°F			

## Input Decimal Point Place

If the following range is selected in [Input type], then the decimal point place can be selected when the input value is displayed.

[K -200 to 200°C], [K 0 to 400°C], [J -200 to 200°C], [J 0 to 400°C]  
[T -100 to 100°C], [Pt100 -100 to 100°C], [JPt100 -100 to 100°C]

Setting Range	Indication		Factory Default
	Multi-Display A	Multi-Display B	
No decimal point			No decimal point 
1 digit after decimal point			

## Output 0% Value

Sets an input value (indicated on the display) at the time of output 0%.

Values change in accordance with the input type and input unit.

Setting Range	Indication		Factory Default
	Multi-Display A	Multi-Display B	
Low limit of each input type to Output 100% value		Set value	-200 

## Output 100% Value

Sets an input value (indicated on the display) at the time of output 100%.

Values change in accordance with the input type and input unit.

Setting Range	Indication		Factory Default
	Multi-Display A	Multi-Display B	
Output 0% value to High limit of each input type		Set value	1370 

## Indication Unit

Selects the unit for indication.

Setting Range	Indication		Factory Default
	Multi-Display A	Multi-Display B	
No unit			No unit 
%			
mA			
V			
°C			

## Save Settings















Selects whether the settings are saved (registered) or not.

Setting Range	Indication		Factory Default
	Multi-Display A	Multi-Display B	
Save	SAVE	SSS	Save SSS SSS
Not save		NSSS	

### 6.3 Output Setting Mode







#### Output Type

Selects an output type.

Setting Range	Indication		Factory Default
	Multi-Display A	Multi-Display B	
4 to 20 mA			4 to 20 mA 
0 to 20 mA			
0 to 16 mA			
2 to 10 mA			
0 to 10 mA			
0 to 10 mV			
0 to 100 mV			
0 to 1 V			
0 to 5 V			
1 to 5 V			
0 to 10 V			
-5 to 5 V			

#### Output Decimal Point Place



Selects the decimal point place for the output.

Setting Range	Indication		Factory Default
	Multi-Display A	Multi-Display B	
No decimal point			2 digits after decimal point * 
1 digit after decimal point			
2 digits after decimal point			
3 digits after decimal point			

\* If '0 to 10 mV', '0 to 100 mV' or '-5 to 5 V' is selected in [Output type], the factory default will be '1 digit after decimal point'.

#### Indication Value at Output 0%

Sets an indication value at the time of output 0%.

Setting Range	Indication		Factory Default
	Multi-Display A	Multi-Display B	
-1999 to Indication value at output 100%		Set value	4.00 

### Indication Value at Output 100%

Sets an indication value at the time of output 100%.

Setting Range	Indication		Factory Default
	Multi-Display A	Multi-Display B	
Indication value at output 0% to 9999		Set value	20.00 

### Output Normal/Reverse

Selects either Normal mode or Reverse mode for output status.

Setting Range	Indication		Factory Default
	Multi-Display A	Multi-Display B	
Normal			Normal 
Reverse			

### Math Function Value Decimal Point Place

Selects the decimal point place when the math function value is indicated.

Setting Range	Indication		Factory Default
	Multi-Display A	Multi-Display B	
No decimal point			1 digit after decimal point 
1 digit after decimal point			
2 digits after decimal point			
3 digits after decimal point			

### Math Function Value at Output 0%

Sets the math function value (from math function results) at the time of Output 0%.

Setting Range	Indication		Factory Default
	Multi-Display A	Multi-Display B	
-1999 to Math function value at Output 100%		Set value	0.0 

### Math Function Value at Output 100%

Sets the math function value (from math function results) at the time of Output 100%.

Setting Range	Indication		Factory Default
	Multi-Display A	Multi-Display B	
Math function value at Output 0% to 9999		Set value	100.0 

## Save Settings

Selects whether the settings are saved (registered) or not.

Setting Range	Indication		Factory Default
	Multi-Display A	Multi-Display B	
Save	SAVE	SSS	Save SSS SSS
Not save		NS	

## 6.4 Math Function Setting Mode

### 4 Math Functions

Selects one from the following:

Addition, Subtraction, Multiplication, Division

Setting Range	Indication		Factory Default
	Multi-Display A	Multi-Display B	
Addition			Subtraction 
Subtraction			
Multiplication			
Division			

### Input 1 Coefficient

Sets Input 1 coefficient.

Setting Range	Indication		Factory Default
	Multi-Display A	Multi-Display B	
0.001 to 2.000		Set value	1.000 

### Input 2 Coefficient

Sets Input 2 coefficient.

Setting Range	Indication		Factory Default
	Multi-Display A	Multi-Display B	
0.001 to 2.000		Set value	1.000 

### Save Settings

Selects whether the settings are saved (registered) or not.

Setting Range	Indication		Factory Default
	Multi-Display A	Multi-Display B	
Save			Save 
Not save			



## 6.5 Instrument Setting Mode

### Input 1 Filter Time Constant

Sets Input 1 filter time constant.

Input fluctuation due to noise can be decreased.

Setting Range	Indication		Factory Default
	Multi-Display A	Multi-Display B	
0.0 to 10.0 seconds		Set value	0.0 sec 

### Input 1 Sensor Correction

Sets Input 1 sensor correction value.

Input value = Current input value + (Sensor correction value)

Setting Range	Indication		Factory Default
	Multi-Display A	Multi-Display B	
-100.0 to 100.0		Set value	0.0 

### Input 2 Filter Time Constant

Sets Input 2 filter time constant.

Input fluctuation due to noise can be decreased.

Setting Range	Indication		Factory Default
	Multi-Display A	Multi-Display B	
0.0 to 10.0 seconds		Set value	0.0 sec 

### Input 2 Sensor Correction

Sets Input 2 sensor correction value.

Input value = Current input value + (Sensor correction value)

Setting Range	Indication		Factory Default
	Multi-Display A	Multi-Display B	
-100.0 to 100.0		Set value	0.0 

### Input burnout Status

Selects either overscale or underscale when input is burnt out.

Setting Range	Indication		Factory Default
	Multi-Display A	Multi-Display B	
Overscale			Overscale 
Underscale			

### Indication Time

Sets duration from no operation until indication (of Multi-Display A, Multi-Display B, and each action indicator) turns off.

They remain lit in setting mode, or in the event of an input error or input burnout.

When set to 00.00, they remain lit.

After indication time has elapsed, and if any key is pressed while they are unlit, they will light up again.

Setting Range	Indication		Factory Default
	Multi-Display A	Multi-Display B	
00 : 00 to 60 : 00 (Minutes : Seconds) 00 : 00..... Continuous 00 : 01 to 60 : 00.. Indication time		Set value	30 : 00 (Minutes : Seconds) 

### Auto/Manual

If AUTO is selected, the output value corresponding to the input value will be output.

When MANUAL is selected, the unit can enter Manual mode. The output value set in Manual mode will be output.

Setting Range	Indication		Factory Default
	Multi-Display A	Multi-Display B	
Auto			Manual 
Manual			

### Manual Mode Auto Return Time

Sets duration from manual mode until the unit automatically returns to the Default Display.

If set to 0 (zero), auto return will not occur.

Setting Range	Indication		Factory Default
	Multi-Display A	Multi-Display B	
0 to 60 minutes		Set value	30 minutes 

### Save Settings

Selects whether the settings are saved (registered) or not.

Setting Range	Indication		Factory Default
	Multi-Display A	Multi-Display B	
Save	SAFE	SSS	Save SAFE SAFE SAFE
Not save		NOSS	

## 6.6 Custom Display Setting Mode

Customizes characters to be indicated on the Multi-Display A and B (\*).  
Use alphanumeric characters and symbols.

(e.g.) FLOW, TEMP, No.1, No.2

(\*) Number of characters which can be indicated differs depending on the display mode.

Refer to Section 5. Display Mode. (pp.13 to 15)



- If Custom display mode 1 is selected:  
Up to 8 characters can be displayed in total for both Multi-Display A and B.
- If any of Custom display mode 2 to 5 is selected:  
Up to 4 characters can be displayed on the Multi-Display B.

Can be set from the thousands digit of the display.

Digits can be selected with the MODE key.



### Multi-Display A

Characters for the Multi-Display A can be customized.

Setting Range	Indication		Factory Default
	Multi-Display A	Multi-Display B	
A to Z, 0 to 9, /, -, ., (Blank)		Set value	AAAA 





### Multi-Display B

Characters for the Multi-Display B can be customized.

Setting Range	Indication		Factory Default
	Multi-Display A	Multi-Display B	
A to Z, 0 to 9, /, -, ., (Blank)		Set value	AAAA 

### Save Settings

Selects whether the settings are saved (registered) or not.

Setting Range	Indication		Factory Default
	Multi-Display A	Multi-Display B	
Save			Save 
Not save			

## 6.7 Manual Mode

If MANUAL is selected in [Auto/Manual] in Instrument setting mode, press the DOWN key for 3 seconds on the Default Display. Then the unit will enter Manual mode.

At this time, Multi-Display A flashes the output value,

The output value can be set by the UP or DOWN key.

The output value is lit while setting.

By pressing the MODE key in Manual mode, or after Manual mode auto return time has elapsed, the unit returns to the Default Display, and outputs the value corresponding to the input value.

# 7. Adjustment

Performs the output zero and span adjustments.

For this instrument, the output adjustment has already been completed when shipped.

If the instrument is used with the ordered Input/Output spec, the adjustment is not required.

However, for calibration, or for the fine adjustment of the SGQ to which any equipment is connected, perform the adjustment.

Connect an mV generator or Dial resistor to the input terminals of this instrument.

Connect a digital multimeter to the output terminals.

## 7.1 Basic Operation of Adjustment

Use the following trimmers on the front panel for adjustment.

Output Zero: Adjusts the value of Output Zero.

Output Span: Adjusts the value of Output Span.

## 7.2 Adjustment

Perform adjustment as follows.

### 7.2.1 Output Adjustment

The following outlines the procedure for Output adjustment.

- ① Enter the value corresponding to output 0%, and adjust the value using the 'Output Zero' trimmer while viewing the output value (on the digital multimeter).
- ② Enter the value corresponding to output 100%, and adjust the value using the 'Output Span' trimmer while viewing the output value (on the digital multimeter).
- ③ Enter the value corresponding to output 0% again, and confirm the output value (on the digital multimeter).
- ④ If the value corresponding to output 0% is not at 0%, repeat steps ① to ③ again.

# 8. Operation

## 8.1 Indication after Power-on

After the power is turned on, the instrument is switched to warm-up status for 3 seconds. Multi-Display A indicates the model name, and Multi-Display B indicates the input code and output code.

(e.g.) SGQ-K01-0-0

Multi-Display A: 

Multi-Display B: 

For the output, a value corresponding to input 0% will be output.

## 8.2 Operation

After warm-up indication, the unit enters display mode.

The input signal selected in [Input type] will be converted to the output selected in [Output type].

### 8.2.1 Input Indication Range

The input value is indicated within the following range:

[Input range low limit – (Input span) × 10%] to

[Input range high limit + (Input span) × 10%]

When the input value exceeds the indication range:  will flash.

When the input value drops below the indication range:  will flash.

### 8.2.2 Output Indication Range

The output value is indicated within the following range:

[Indication value at output 0% – (Indication value at output 100% – Indication value at output 0%) × 10%] to

[Indication value at output 100% + (Indication value at output 100% – Indication value at output 0%) × 10%]

For a value lower than (and including) -2000, the output value and the minus (-) sign will be indicated alternately. For a value higher than (and including) 10000, the lower 4 digits will flash. (The placement of the decimal point follows the selection.)

### 8.2.3 Input Burnout Status

Overscale or underscale can be selected in the event of an input burnout.

If overscale is selected, the output is forcibly limited to 110%.

If underscale is selected, the output is forcibly limited to 0%.

When overscale is selected: If input is burnt out, the Alarm indicator will light up, and  will flash.

When underscale is selected: If input is burnt out, the Alarm indicator will light up, and  will flash.

### 8.2.4 Indication Time Setting

After preset indication time has elapsed, Multi-Display A, Multi-Display B and

each action indicator are turned OFF. They will light up again if any key is pressed.

They remain lit during setting mode, or in the event of an input error or input burnout.

If the indication time is set to 00:00, they will remain lit.

### 8.2.5 Four Math Functions

Input 1 and Input 2 are calculated using 4 math functions, and produce an output value. However, the sensor correction value is included in Input 1 and Input 2.

#### ■ Adder

If Addition is selected in [4 math functions], the sum of the inputs (Input 1 + Input 2) will be output. Refer to the addition equation below.

$$\text{Output value} = \text{Input 1 value} \times K_1 + \text{Input 2 value} \times K_2$$

$K_1$  : Input 1 coefficient 0.001 to 2.000

$K_2$  : Input 2 coefficient 0.001 to 2.000

- Input 1 value, Input 2 value: 0.0 to 100.0%
- Even if the output value results are below -10.0%, the output value is forcibly limited to -10.0%.

Even if the output value results are above 110%, the output value is forcibly limited to 110.0%.

#### ■ Subtractor

If Subtraction is selected in [4 math functions], the difference of the inputs (Input 1 – Input 2) will be output. Refer to the subtraction equation below.

$$\text{Output value} = \text{Input 1 value} \times K_1 - \text{Input 2 value} \times K_2$$

$K_1$  : Input 1 coefficient 0.001 to 2.000

$K_2$  : Input 2 coefficient 0.001 to 2.000

- Input 1 value, Input 2 value: 0.0 to 100.0%
- Even if the output value results are below -10.0%, the output value is forcibly limited to -10.0%.

Even if the output value results are above 110%, the output value is forcibly limited to 110.0%.

#### ■ Multiplier

If Multiplication is selected in [4 math functions], the product of the inputs (Input 1 x Input 2) will be output. Refer to the multiplication equation below.

$$\text{Output value} = \text{Input 1 value} \times K_1 \times \text{Input 2 value} \times K_2$$

$K_1$  : Input 1 coefficient 0.001 to 2.000

$K_2$  : Input 2 coefficient 0.001 to 2.000

- Input 1 value, Input 2 value: 0.0 to 100.0%
- Even if the output value results are below -10.0%, the output value is forcibly limited to -10.0%.

Even if the output value results are above 110%, the output value is forcibly limited to 110.0%.

#### ■ Divider

If Division is selected in [4 math functions], the quotient of the inputs (Input 1 / Input 2) will be output. Refer to the division equation below.

$$\text{Output value} = (\text{Input 1 value} \times K_1) / (\text{Input 2 value} \times K_2)$$

$K_1$  : Input 1 coefficient 0.001 to 2.000

$K_2$  : Input 2 coefficient 0.001 to 2.000

- Input 1 value, Input 2 value: 0.0 to 100.0%
- Even if the output value results are below -10.0%, the output value is forcibly limited to -10.0%.

Even if the output value results are above 110%, the output value is forcibly limited to 110.0%.

# 9. Specifications

## Input 1 Specifications

<b>Thermocouple input</b>	K, J, R, S, B, E, T, N, PL-II, W5Re/W26Re, W3Re/W25Re External resistance: 100 Ω max. (However, thermocouple B: 40 Ω max.)		
	<b>Input:</b>		
	<b>Thermocouple</b>	<b>Input Range *1</b>	<b>Indication Resolution</b>
	K	-200 to 1370 °C (-328 to 2498 °F)	1 °C (1 °F)
		-200 to 200 °C*2,*3 (-328 to 392 °F)*2,*3	1 °C (1 °F)*2
		0 to 400 °C*2 (32 to 752 °F)*2	1 °C (1 °F)*2
	J	-200 to 1000 °C (-328 to 1832 °F)	1 °C (1 °F)
		-200 to 200 °C*2,*3 (-328 to 392 °F)*2,*3	1 °C (1 °F)*2
		0 to 400 °C*2 (32 to 752 °F)*2	1 °C (1 °F)*2
	R	-50 to 1760 °C (-58 to 3200 °F)	1 °C (1 °F)
	S	-50 to 1760 °C (-58 to 3200 °F)	1 °C (1 °F)
	B	0 to 1820 °C (32 to 3308 °F)	1 °C (1 °F)
	E	-200 to 800 °C (-328 to 1472 °F)	1 °C (1 °F)
	T	-200 to 400 °C (-328 to 752 °F)	1 °C (1 °F)
		-100 to 100 °C*2 (-148 to 212 °F)*2	1 °C (1 °F)*2
N	-200 to 1300 °C (-328 to 2372 °F)	1 °C (1 °F)	
PL-II	0 to 1390 °C (32 to 2534 °F)	1 °C (1 °F)	
W5Re/W26Re	0 to 2315 °C (32 to 4199 °F)	1 °C (1 °F)	
W3Re/W25Re	0 to 2315 °C (32 to 4199 °F)	1 °C (1 °F)	
*1: °C or °F can be selected in [Input unit].			
*2: 'No decimal point' and '1 digit after decimal point' can be selected.			
*3: If '1 digit after decimal point' is selected, the low limit value will be -199.9.			



<b>RTD input</b>	Pt100, JPt100 3-wire type Input detection current: Approx. 200 $\mu$ A Allowable lead wire resistance: 200 $\Omega$ max. per wire <b>Input:</b>		
	<b>RTD</b>	<b>Input Range <sup>*1</sup></b>	
		<b>Indication Resolution</b>	
	Pt100	-200 to 650 $^{\circ}$ C (-328 to 1202 $^{\circ}$ F)	1 $^{\circ}$ C (1 $^{\circ}$ F)
		-100 to 100 $^{\circ}$ C <sup>*2</sup> (-148 to 212 $^{\circ}$ F) <sup>*2</sup>	1 $^{\circ}$ C (1 $^{\circ}$ F) <sup>*2</sup>
JPt100	-200 to 500 $^{\circ}$ C (-328 to 932 $^{\circ}$ F)	1 $^{\circ}$ C (1 $^{\circ}$ F)	
	-100 to 100 $^{\circ}$ C <sup>*2</sup> (-148 to 212 $^{\circ}$ F) <sup>*2</sup>	1 $^{\circ}$ C (1 $^{\circ}$ F) <sup>*2</sup>	
*1: $^{\circ}$ C or $^{\circ}$ F can be selected in [Input unit].			
*2: 'No decimal point' and '1 digit after decimal point' can be selected in [Decimal point place].			

### Input 2 Specifications

Same as Input 1 Specifications

### Output Specifications

<b>Direct current</b>	<b>Output Range</b>	<b>Allowable Load Resistance</b>	<b>Zero Adjustment Range</b>	<b>Span Adjustment Range</b>
	4 to 20 mA	750 $\Omega$ max.	-5 to 5%	95 to 105%
	0 to 20 mA*	750 $\Omega$ max.		
	0 to 16 mA*	900 $\Omega$ max.		
	2 to 10 mA	1500 $\Omega$ max.		
	0 to 10 mA*	1500 $\Omega$ max.		
* 0 mA or less: Out of base accuracy				
<b>DC voltage</b>	<b>Output Range</b>	<b>Allowable Load Resistance</b>	<b>Zero Adjustment Range</b>	<b>Span Adjustment Range</b>
	0 to 10 mV*	10 k $\Omega$ min.	-5 to 5%	95 to 105%
	0 to 100 mV*	100 k $\Omega$ min.		
	0 to 1 V*	1000 $\Omega$ min.		
	0 to 5 V*	5000 $\Omega$ min.		
	1 to 5 V	5000 $\Omega$ min.		
	0 to 10 V*	10 k $\Omega$ min.		
-5 to 5 V	10 k $\Omega$ min.			
* 0 V or less: Out of base accuracy				

## Performance

<b>Base accuracy (at 25°C)</b>	<p>±0.1% of each input span</p> <p>Thermocouple input</p> <p>When input is 0°C or less: Base accuracy + (±0.1% of each input span)</p> <p>When input has a decimal point: Base accuracy + (±0.05% of each input span)</p> <p>R, S input, 0 to 200°C (32 to 392°F): ±0.3% of each input span</p> <p>B input, 0 to 300°C (32 to 572°F): Accuracy is not guaranteed.</p> <p>Adder: If <math>K_1</math> or <math>K_2</math> exceeds 1.00: ±0.4% of each input span</p> <p>Subtractor: If <math>K_1</math> or <math>K_2</math> exceeds 1.00: ±0.4% of each input span</p> <p>Multiplier: If <math>K_1 \times K_2</math> exceeds 1.00: ±0.4% of each input span</p> <p>Divider: <math>K_1 \div K_2 \leq 1.00</math>: ±1.0% of each input span <math>K_1 \div K_2 &gt; 1.00</math>: ±2.0% of each input span</p>
<b>Cold junction compensation accuracy</b>	±0.5°C (1.0°F) at 20±10°C
<b>Temperature coefficient</b>	±0.015 %/°C 0 to 10 mV output: ±0.02 %/°C
<b>Effect of allowable input lead wire resistance</b>	<p>RTD input</p> <p>Less than 20 Ω per wire: Base accuracy</p> <p>20 Ω or more per wire: Base accuracy + 0.005 %/Ω</p>
<b>Response time</b>	500 ms max. (0→90%)
<b>Indication update cycle</b>	125 ms
<b>Indication accuracy</b>	Base accuracy ±1 digit
<b>Insulation resistance</b>	100 MΩ minimum, at 500 V DC
<b>Dielectric strength</b>	2.0 kV AC for 1 minute

## General Structure

<b>Dimensions</b>	22.5 x 89 x 70 mm (W x H x D)
<b>Weight</b>	Approx. 76 g
<b>Mounting</b>	DIN rail
<b>Case</b>	Flame-resistant resin, Color: Black
<b>Front panel</b>	Polycarbonate

## Installation Specifications



<b>Power supply</b>	100 to 240 V AC 50/60 Hz
<b>Allowable voltage range</b>	85 to 264 V AC
<b>Power consumption</b>	Approx. 9 VA max.
<b>Ambient temperature</b>	-10 to 55°C (Non-condensing, no icing)
<b>Ambient humidity</b>	35 to 85 %RH (Non-condensing)

## Standard Function

<b>Power failure countermeasure</b>	The setting data is backed up in the non-volatile IC memory.
<b>Self-diagnosis</b>	The CPU is monitored by a watchdog timer, and if an abnormal status occurs, the instrument is switched to warm-up status, turning all outputs OFF.
<b>Automatic cold junction temperature compensation</b>	<p>When thermocouple input is selected, this detects the temperature at the connecting terminal between the thermocouple and the instrument, and always maintains it at the same status as if the reference junction location temperature was at 0°C (32°F).</p> <p>If the cold junction connected to terminals is burnt out, the Multi-Display A indicates , and the Multi-Display B is unlit. At this time, the instrument status will be the same as the selection in [Input burnout status].</p> <p>(Either overscale or underscale selected in [Input burnout status] will be indicated.)</p>

# 10. Troubleshooting

## 10.1 Indication

Problem	Possible Cause	Solution
Multi-Display A or B flashes  or  when it indicates an input value.	The sensor may be burnt out.	Replace with a new sensor.
	Check whether the sensor is securely mounted to the input terminals of this instrument.	Connect the sensor terminals to the instrument input terminals securely.
	Check the input signal source.	Ensure that the input signal source works normally.
	Check if polarity of thermocouple or compensating lead wire is correct. Check whether codes (A, B, B) of RTD agree with the instrument terminals.	Wire them correctly.
Multi-Display A or B is irregular or unstable when it indicates an input value.	Check whether sensor input or unit (°C/°F) is correct.	Select the same sensor type and unit (°C/°F) as those of currently used sensor.
	Sensor correction value is unsuitable.	Set it to a suitable value.
	AC leaks into the sensor circuit.	Use an ungrounded type sensor.
	There may be equipment that interferes with or makes noise near the instrument.	Keep the instrument clear of any potentially disruptive equipment.
Displays and indicators are unlit. If any key is pressed, they will light up.	The Indication Time (p.26) is set to any value other than 00 : 00. (Factory default is 30 : 00.)	To indicate continuously, set the Indication Time (p.26) to "00 : 00".

## 10.2 Key Operation

Problem	Possible Cause	Solution
If the DISP key is pressed, Multi-Display A shows  , and it is not possible to switch the display modes.	The DISP key is in locked status.	Press the DISP key for approx. 3 seconds to release the key lock.

### 10.3 Operation

<b>Problem</b>	<b>Possible Cause</b>	<b>Solution</b>
When Multi-Display A or B indicates an input value, the input value does not change.	The sensor may be out of order.	Replace with the new sensor.
	Check whether input and output wires are securely connected to the I/O terminals of the instrument.	Ensure that input and output wires are securely connected to the I/O terminals of the instrument.
	Check whether the wiring of input and output are correct.	Wire them correctly.
No output	Selections in [Output type (p.21)] or [Output Normal/Reverse (p.22)] may be incorrect.	Make a correct selection in [Output type (p.21)] or [Output Normal/Reverse (p.22)].

# 11. Character Table

Please use the following factory default values for your reference.

## Display mode

Setting Item	Multi-Display A	Multi-Display B	Data
Default display mode	Follows currently indicated display mode.		
RUN display mode 1	Input 1 value	Output value	
RUN display mode 2	Input 2 value	Output value	
RUN display mode 3	Input 1 value	Input 2 value	
RUN display mode 4	Input 1 value	Unlit	
RUN display mode 5	Input 2 value	Unlit	
RUN display mode 6	Unlit	Output value	
RUN display mode 7	Input math function value	Output value	
Custom display mode 1			
Custom display mode 2	Input 1 value		
Custom display mode 3	Input 2 value		
Custom display mode 4	Output value		
Custom display mode 5	Input math function value		
Unlit display mode	Unlit (Input indicator A lit)	Unlit	
All unlit display mode	Unlit	Unlit	
Model display mode	Model	Input, Output codes	

## Setting mode

Setting Item	Multi-Display A	Multi-Display B	Data
Input setting mode		Unlit	
Output setting mode		Unlit	
Math function setting mode		Unlit	
Instrument setting mode		Unlit	
Custom display setting mode		Unlit	

## Input setting mode

Setting Item	Multi-Display A	Multi-Display B	Data
Input group			
Input type *	Thermocouple input		
	RTD input		
Input unit			
Input decimal point place			
Output 0% value			
Output 100% value			
Indication unit			
Save settings			

\* Indication differs depending on the selection in [Input group].

### Output setting mode

Setting Item	Multi-Display A	Multi-Display B	Data
Output type	0000	0000	
Output decimal point place	0000	0000	
Indication value at output 0%	0000	0000	
Indication value at output 100%	0000	0000	
Output Normal/Reverse	0000	0000	
Math function value decimal point place	0000	0000	
Math function value at output 0%	0000	0000	
Math function value at output 100%	0000	0000	
Save settings	0000	0000	

### Math function setting mode

Setting Item	Multi-Display A	Multi-Display B	Data
4 math functions	0000	0000	
Input 1 coefficient	0000	0000	
Input 2 coefficient	0000	0000	
Save settings	0000	0000	

### Instrument setting mode

Setting Item	Multi-Display A	Multi-Display B	Data
Input 1 filter time constant	0000	0000	
Input 1 sensor correction	0000	0000	
Input 2 filter time constant	0000	0000	
Input 2 sensor correction	0000	0000	
Input burnout status	0000	0000	
Indication time	0000	0000	
Auto/Manual	0000	0000	
Manual mode auto return time	0000	0000	
Save settings	0000	0000	

### Custom display setting mode

Setting Item	Multi-Display A	Multi-Display B	Data
Multi-Display A	0000	0000	
Multi-Display B	0000	0000	
Save settings	0000	0000	

\*\*\*\*\* Inquiries \*\*\*\*\*

For any inquiries about this unit, please contact our agency or the vendor where you purchased the unit after checking the following.

[Example]

- Model ----- SGQ-K01-0-0
- Serial number ----- 154F05000

In addition to the above, please let us know the details of the malfunction, or discrepancy, and the operating conditions.

**SHINKO TECHNOS CO., LTD.**  
**OVERSEAS DIVISION**

Head Office: 2-5-1, Senbahigashi, Minoo, Osaka, 562-0035, Japan

[URL] <https://shinko-technos.co.jp/e/>

Tel: +81-72-727-6100

[E-mail] [overseas@shinko-technos.co.jp](mailto:overseas@shinko-technos.co.jp)

Fax: +81-72-727-7006

No.SGQ11E4 2021.06