

RTD TRANSMITTER

SGR

SGRW

SGRL

INSTRUCTION MANUAL

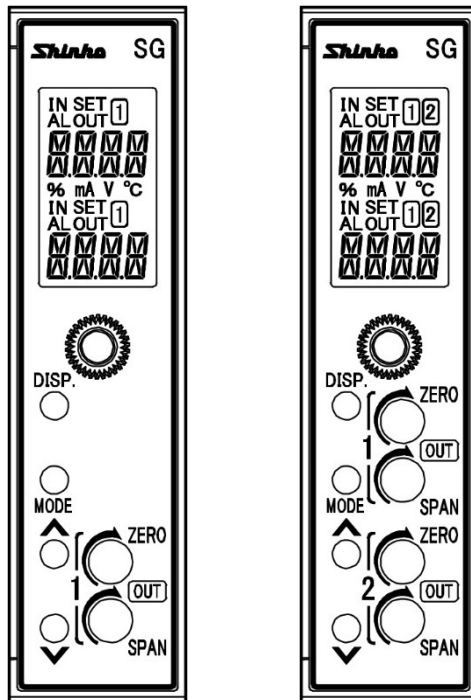

Shinko

Preface

Thank you for purchasing our SGR, SGRW or SGRL, RTD Transmitter. This manual contains instructions for the mounting, functions, operations and notes when operating the SGR, SGRW or SGRL. To prevent accidents arising from the misuse of this instrument, please ensure the operator receives this manual.

Notes

- This instrument should be used in accordance with the specifications described in the manual. If it is not used according to the specifications, it may malfunction or cause a fire.
- Be sure to follow the warnings, cautions and notices. If they are not observed, serious injury or malfunction may occur.
- The contents of this instruction manual are subject to change without notice.
- Care has been taken to ensure that the contents of this instruction manual are correct, but if there are any doubts, mistakes or questions, please inform our sales department.
- This instrument is designed to be installed on a DIN rail within a control panel. If it is not, measures must be taken to ensure that the operator does not touch power terminals or other high voltage sections.
- Any unauthorized transfer or copying of this document, in part or in whole, is prohibited.
- Shinko Technos Co., Ltd. is not liable for any damage or secondary damage(s) incurred as a result of using this product, including any indirect damage.

SAFETY PRECAUTIONS (Be sure to read these precautions before using our products.)

The safety precautions are classified into categories: "Warning" and "Caution".

Depending on circumstances, procedures indicated by  Caution may result in serious consequences, so be sure to follow the directions for usage.



Warning

Procedures which may lead to dangerous conditions and cause death or serious injury, if not carried out properly.



Caution

Procedures which may lead to dangerous conditions and cause superficial to medium injury or physical damage or may degrade or damage the product, if not carried out properly.



Warning

- To prevent an electrical shock or fire, only Shinko or qualified service personnel may handle the inner assembly.
- To prevent an electrical shock, fire, or damage to instrument, parts replacement may only be undertaken by Shinko or qualified service personnel.



Safety Precautions

- To ensure safe and correct use, thoroughly read and understand this manual before using this instrument.
- This instrument is intended to be used for industrial machinery, machine tools and measuring equipment. Verify correct usage after purpose-of-use consultation with our agency or main office. (Never use this instrument for medical purposes with which human lives are involved.)
- External protection devices such as protective equipment against excessive temperature rise, etc. must be installed, as malfunction of this product could result in serious damage to the system or injury to personnel. Proper periodic maintenance is also required.
- This instrument must be used under the conditions and environment described in this manual. Shinko Technos Co., Ltd. does not accept liability for any injury, loss of life or damage occurring due to the instrument being used under conditions not otherwise stated in this manual.



Caution with Respect to Export Trade Control Ordinance

To avoid this instrument from being used as a component in, or as being utilized in the manufacture of weapons of mass destruction (i.e. military applications, military equipment, etc.), please investigate the end users and the final use of this instrument.
In the case of resale, ensure that this instrument is not illegally exported.

■ Installation Precautions



Caution

This instrument is intended to be used under the following environmental conditions (IEC61010-1): Overvoltage category II, Pollution degree 2

Ensure the mounting location corresponds to the following conditions:

- A minimum of dust, and an absence of corrosive gases
- No flammable, explosive gases
- No mechanical vibrations or shocks
- No exposure to direct sunlight, an ambient temperature of -10 to 55°C (14 to 131°F) that does not change rapidly, and no icing
- An ambient non-condensing humidity of 35 to 85 %RH
- No large capacity electromagnetic switches or cables through which large current is flowing
- No water, oil or chemicals or the vapors of these substances can come into direct contact with the unit.
- When installing this unit within a control panel, please note that ambient temperature of this unit – not the ambient temperature of the control panel – must not exceed 55°C (131°F). Otherwise the life of electronic components (especially electrolytic capacitor) may be shortened.

Note: Avoid setting this instrument directly on or near flammable material even though the case of this instrument is made of flame-resistant resin.

■ Wiring Precautions



Caution

- Do not leave bits of wire in the instrument, because they could cause a fire and malfunction.
- When wiring, use a crimping pliers and a solderless terminal with an insulation sleeve in which an M3 screw fits.
- Tighten the terminal screw using the specified torque. If excessive force is applied to the screw when tightening, the screw or case may be damaged.
- This instrument does not have a built-in power switch, circuit breaker and fuse. It is necessary to install a power switch, circuit breaker and fuse near the instrument. (Recommended fuse: Time-lag fuse, rated voltage 250 V AC, rated current 2 A)
- For wiring of the AC power source, be sure to use terminals as described in this manual. If the AC power source is connected to incorrect terminals, the unit will be burnt out.
- Do not apply a commercial power source to the sensor which is connected to the input terminal nor allow the power source to come into contact with the sensor.
- Use the 3-wire RTD according to the sensor input specifications of this instrument.
- When using DC voltage and current input, do not confuse polarity when wiring.
- Keep the input/output wires and power line separate.

■ Operation and Maintenance Precautions



Caution

- Do not touch live terminals. This may cause an electrical shock or problems in operation.
- Turn the power supply to the instrument OFF when retightening the terminal or cleaning. Working on or touching the terminal with the power switched ON may result in severe injury or death due to electrical shock.
- Use a soft, dry cloth when cleaning the instrument. (Alcohol based substances may tarnish or deface the unit.)
- As the display section is vulnerable, be careful not to put pressure on, scratch or strike it with a hard object.

Characters used in this manual [X : No character is indicated (unlit).]

Indication	-1	0	1	2	3	4	5	6	7	8	9	°C	°F
Number, °C/°F	-1	0	1	2	3	4	5	6	7	8	9	°C	°F
Indication	A	b	C	d	E	F	G	H	I	J	K	L	M
Alphabet	A	B	C	D	E	F	G	H	I	J	K	L	M
Indication	N	o	P	Q	R	S	T	U	V	W	X	Y	Z
Alphabet	N	O	P	Q	R	S	T	U	V	W	X	Y	Z

Contents

	Page
1. Model	5
1.1 Model	5
1.2 How to Read the Model Label	6
2. Name and Functions	7
2.1 Front Panel	7
2.2 Display Section	8
3. Mounting	9
3.1 External Dimensions (Scale: mm)	9
3.2 Mounting to, and Removal from the DIN Rail	10
4. Wiring	11
4.1 Lead Wire Solderless Terminal	11
4.2 Circuit Configuration	11
4.3 Terminal Arrangement	13
4.4 Wiring	14
5. Display Mode	15
6. Setting Mode	17
6.1 Display Transition in Setting Mode	17
6.2 Input Setting Mode	19
6.3 Output 1 Setting Mode	21
6.4 Output 2 Setting Mode	23
6.5 Instrument Setting Mode	25
6.6 Communication Setting Mode	27
6.7 Custom Display Setting Mode	29
6.8 Manual Mode	29
7. Adjustment	30
7.1 Basic Operation of Adjustment	30
7.2 Adjustment	30
7.2.1 Output 1 Adjustment	30
7.2.2 Output 2 Adjustment	30
8. Operation	31
8.1 Indication after Power-on	31
8.2 Operation	31
8.2.1 Input Indication Range	31
8.2.2 Indication Range of Output 1 and Output 2	31
8.2.3 Input Burnout Status	31
8.2.4 Indication Time	31
9. Specifications	32
10. Troubleshooting	35
10.1 Indication	35
10.2 Key Operation	35
10.3 Operation	36
11. Character Table	37

1. Model

1.1 Model

SGR

SGR - □ □ □ - □ - □

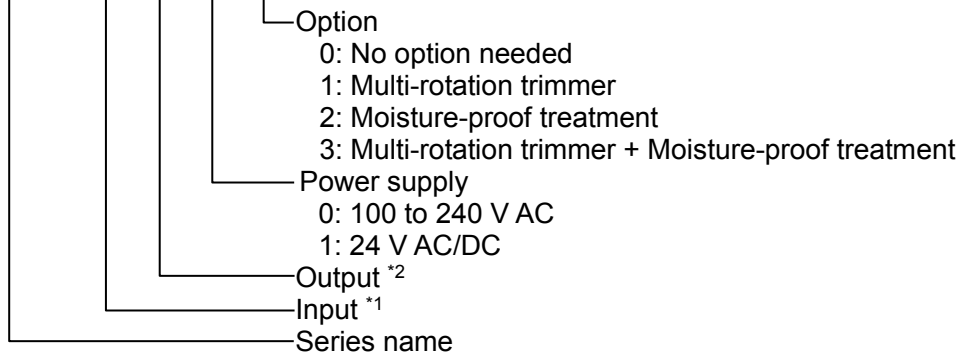

SGRW

SGRW - □ □ □ □ - 0 - □

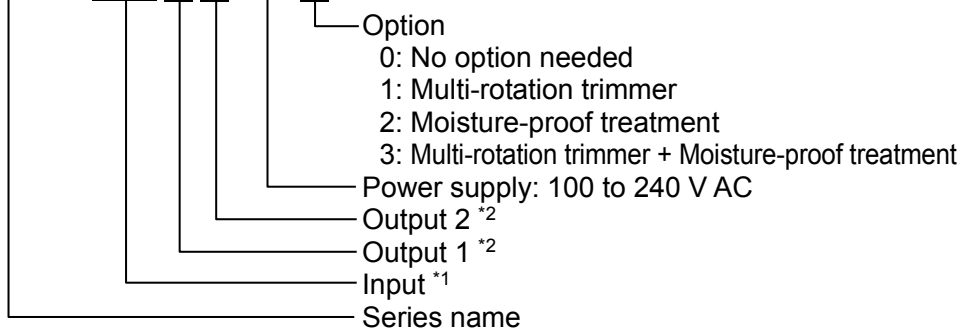

SGRL

SGRL - □ □ □ - 0 - □

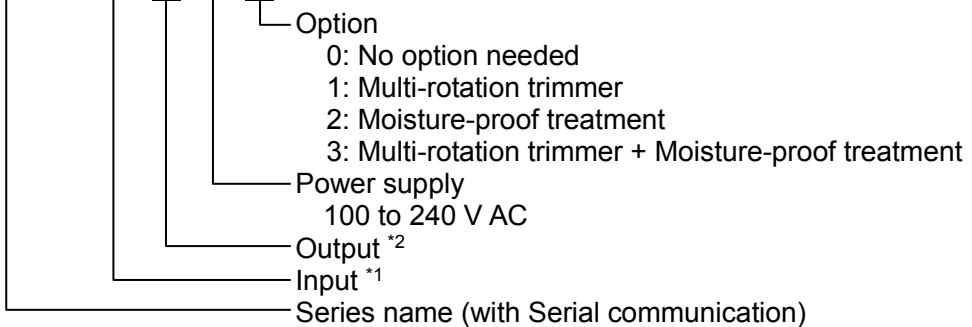

***1: Input**

Code	Input Type	
P0	Pt100	-200 to 650 °C (-328 to 1202 °F)
P1	RTD	-100 to 100 °C (-148 to 212 °F)
P2	JPt100	-200 to 500 °C (-328 to 932 °F)
P3	RTD	-100 to 100 °C (-148 to 212 °F)

***2: Output, Output 1, Output 2**

Code	Output Type	Code	Output Type
1	Current output	A	Voltage output
2		B	
3		C	
4		D	
5		E	
		F	
		G	

* Not available for the SGRW.

1.2 How to Read the Model Label

The model label is attached to the left side of the case.

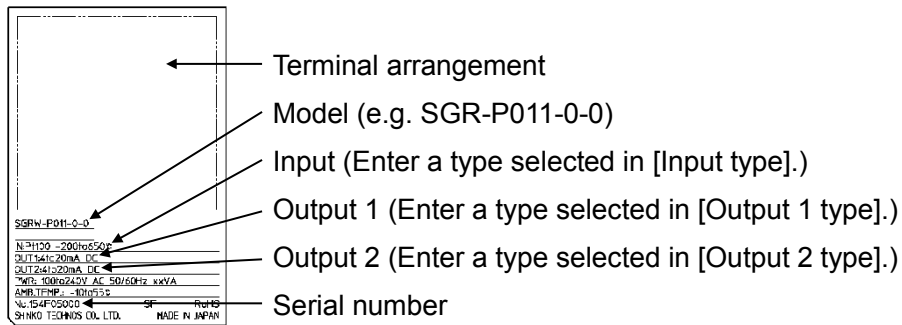

(Fig. 1.2-1)

2. Name and Functions

2.1 Front Panel

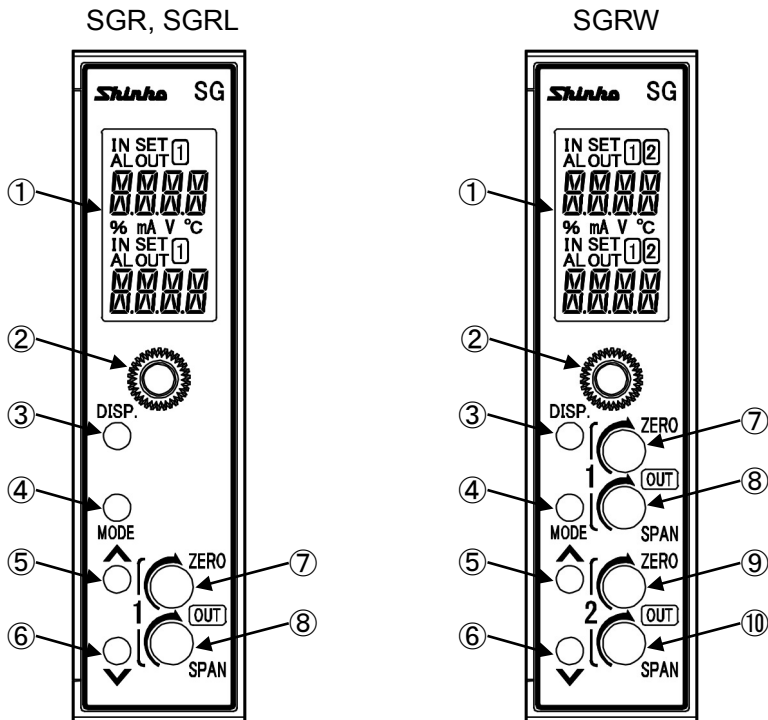

(Fig. 2.1-1)

① Display section	Indicates setting contents, input value, output value, etc.
② Mounting screw	Used for fixing the instrument to the socket or removal from it.
③ DISP key	Switches the displays, and moves to the next setting item. In Manual mode, Output 1 and Output 2 setting can be switched. Releases the lock status of the DISP key by pressing for 3 seconds.
④ MODE key	Selects either a setting mode or a display mode. Shifts the digit for the Custom Display. Enters the setting mode by pressing and holding for 5 seconds.
⑤ UP key	Increases the numerical value. Contents of Multi-Display A and B can be changed alternately when Default Display is RUN display mode 1, 2*, 3, 4*, 5 and 6*.
⑥ DOWN key	Decreases the numerical value. Enters Manual mode by pressing for 3 seconds.
⑦ Output 1 Zero	Adjusts the value of Output 1 Zero.
⑧ Output 1 Span	Adjusts the value of Output 1 Span
⑨ Output 2 Zero*	Adjusts the value of Output 2 Zero.
⑩ Output 2 Span*	Adjusts the value of Output 2 Span.

* For SGRW only

2.2 Display Section

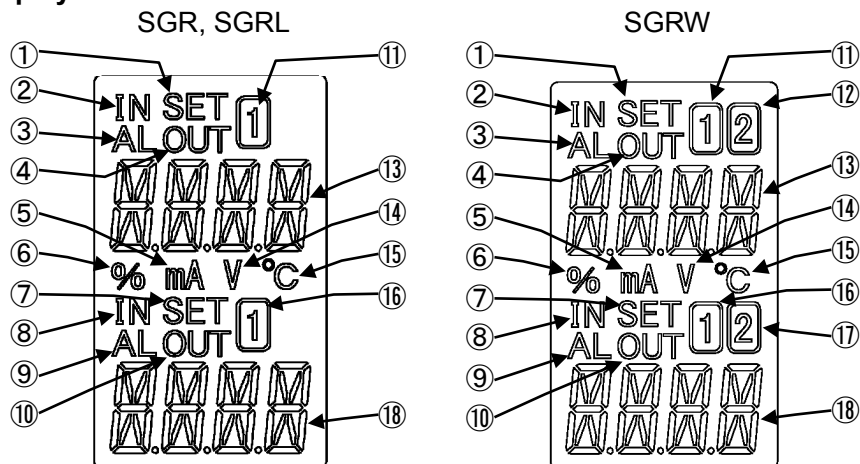

(Fig. 2.2-1)

①	Setting display indicator A	Lights up in Manual mode.
②	Input indicator A	Lights up when Multi-Display A indicates an input value.
③	Alarm indicator A	Lights up if an input error or input burnout occurs while Multi-Display A indicates an input value.
④	Output indicator A	Lights up when Multi-Display A indicates an output value.
⑤	mA indicator	Lights up when mA is selected in [Indication unit].
⑥	% indicator	Lights up when % is selected in [Indication unit].
⑦	Setting display indicator B	Lights up for the setting display. For the SGRW, lights up for the setting display or in Manual mode.
⑧	Input indicator B	Lights up when Multi-Display B indicates an input value.
⑨	Alarm indicator B	Lights up if an input error or input burnout occurs while Multi-Display B indicates an input value.
⑩	Output indicator B	Lights up when Multi-Display B indicates an output value.
⑪	1 indicator A	Lights up when Multi-Display A indicates an input value, Output 1 value, Input setting display or Output 1 setting display. Is turned OFF when Multi-Display A indicates custom characters.
⑫	2 indicator A	Lights up when Multi-Display A indicates Output 2 value or Output 2 setting display. Is turned OFF when Multi-Display A indicates custom characters.
⑬	Multi-Display A	Indicates the following in accordance with the display indication: Input value, output value, custom characters, setting item
⑭	V indicator	Lights up when V is selected in [Indication unit].
⑮	°C indicator	Lights up when °C is selected in [Indication unit].
⑯	1 indicator B	Lights up when Multi-Display B indicates an input value, Output 1 value, Input setting display or Output 1 setting display. Is turned OFF when Multi-Display B indicates custom characters.
⑰	2 indicator B	Lights up when Multi-Display B indicates Output 2 value or Output 2 setting display. Is turned OFF when Multi-Display B indicates custom characters.

⑱	Multi-Display B	Indicates the following in accordance with the display indication: Input value, output value, custom characters, setting value
---	------------------------	---

Output indicators A and B, Alarm indicators A and B: Red
Other indicators: White

3. Mounting

3.1 External Dimensions (Scale: mm)

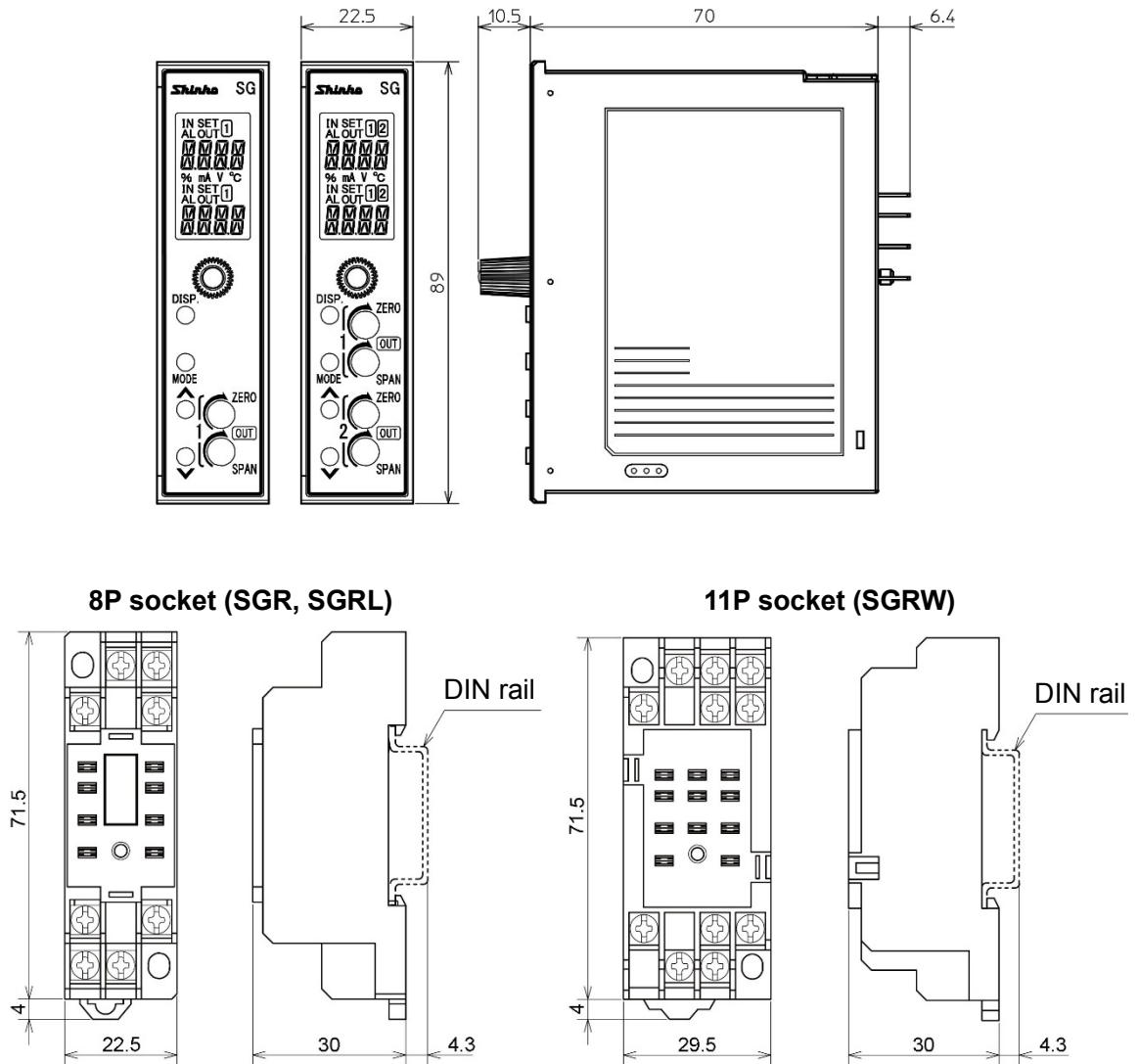

(Fig. 3.1-1)

3.2 Mounting to, and Removal from the DIN Rail



Caution

- Mount the DIN rail horizontally.
- To remove the socket, a flat blade screwdriver is required.
Never turn the screwdriver when inserting it into the Lock lever. If excessive power is applied to the lever, it may break.
- If the instrument is mounted in a position susceptible to vibration or shock, mount commercially available fastening plates at both ends of the instrument.

Recommended Fastening Plate

Manufacturer	Model
Omron Corporation	End plate PFP-M
IDEC Corporation	Fastening plate BNL6
Panasonic Electric Works Co., Ltd.	Fastening plate ATA4806

Mounting to the DIN rail (Fig. 3.2-1)

- ① Separate the instrument from the socket by loosening the mounting screw on the front panel.
- ② Make sure the lock lever of the socket is located in the lower part of the socket. Hook the upper side of the socket onto the DIN rail, then fit the lower part of the socket onto the DIN rail (A clicking sound should be heard when done properly.).



Caution

- Before inserting the instrument to the socket, make sure the cable is wired properly. (Refer to “4. Wiring”.)
- When inserting or removing the socket, make sure the socket is oriented vertically. If force is applied in any other direction than vertically, a malfunction may occur.
- If the mounting screw is fastened too tightly, a malfunction may occur.

- ③ Insert the SGR into the socket.
- ④ Fasten the mounting screw by turning it clockwise, to secure the SGR onto the socket. Tighten the screw lightly.

Removal from the DIN rail (Fig. 3.2-2)

- ① Turn the power to the instrument OFF.
- ② Separate the instrument from the socket by loosening the mounting screw on the front panel.
- ③ Insert a flat blade screwdriver into the Lock lever (lower part of the socket), and remove the socket from the DIN rail while pulling the lever down.

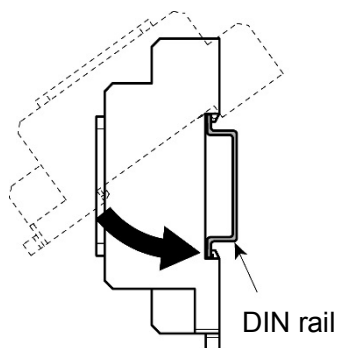

(Fig. 3.2-1)

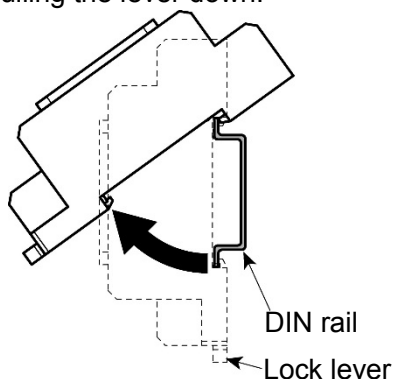

(Fig. 3.2-2)

4. Wiring



Warning

Turn the power supply to the instrument off before wiring or checking. Working on or touching the terminal with the power switched on may result in severe injury or death due to electrical shock.

4.1 Lead Wire Solderless Terminal

Use a solderless terminal with an insulation sleeve in which an M3 screw fits as shown below. The torque should be 0.63 N·m.

Solderless Terminal	Manufacturer	Model
Y-type	Nichifu Terminal Industries Co., Ltd.	TMEV1.25Y-3
	Japan Solderless Terminal MFG Co., Ltd.	VD1.25-B3A
Ring-type	Nichifu Terminal Industries Co., Ltd.	TMEV1.25-3
	Japan Solderless Terminal MFG Co., Ltd.	V1.25-3

Y-type(Scale: mm)

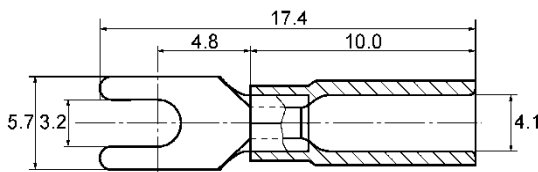

(Fig. 4.1-1)

Ring-type(Scale: mm)

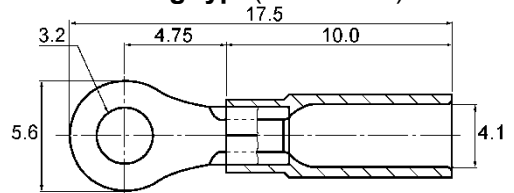

(Fig. 4.1-2)

4.2 Circuit Configuration

SGR, SGRL

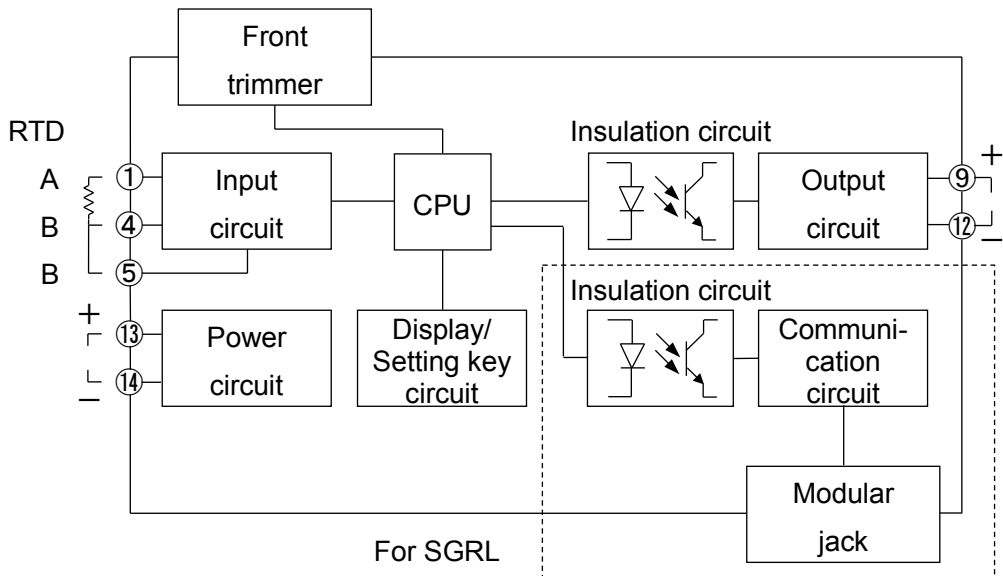

(Fig. 4.2-1)

SGRW

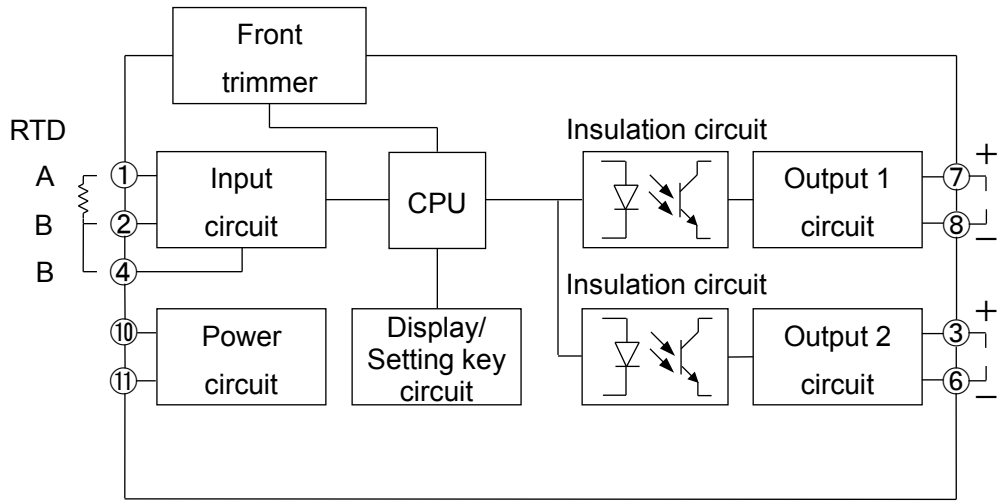

(Fig. 4.2-2)

4.3 Terminal Arrangement

SGR

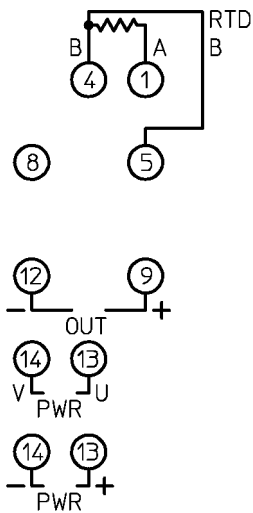

(Fig. 4.3-1)

SGRL

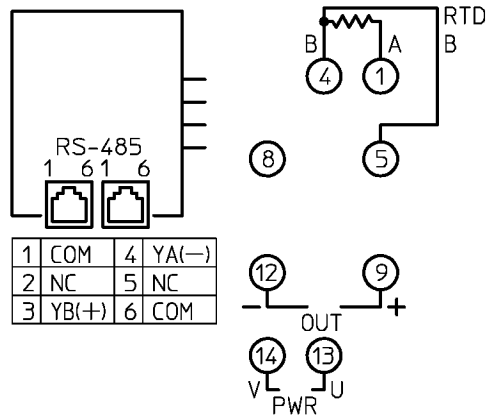

(Fig. 4.3-2)

SGRW

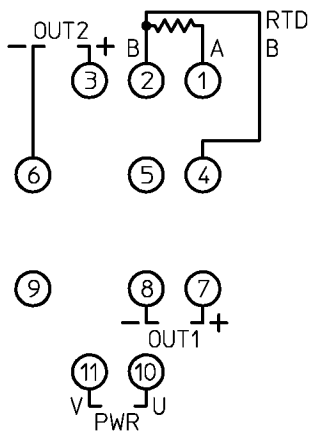

(Fig. 4.3-3)

PWR	Power supply 100 to 240 V AC or 24 V AC/DC (for SGR)
OUT (OUT1)	Output or Output 1 (for SGRW)
OUT2	Output 2 (for SGRW)
RTD	RTD input
RS-485	Serial communication (for SGRL)

4.4 Wiring



Warning

- For 100 to 240 V AC, if the AC power source is connected to incorrect terminals, the instrument will be burnt out.

(1) Power Source Wiring

SGR: Use terminals ⑬, ⑭ for the power supply to the instrument.
For 24 V DC, use terminals ⑬(+), ⑭(-) for the power supply to the instrument.

SGRL: Use terminals ⑬, ⑭ for the power supply to the instrument.

SGRW: Use terminals ⑩, ⑪ for the power supply to the instrument.

(2) Output Wiring

SGR, SGRL: Use terminals ⑨(+), ⑫(-) for the output wiring.

SGRW: Output 1: Use terminals ⑦(+), ⑧(-) for Output 1 wiring.

Output 2: Use terminals ③(+), ⑥(-) for Output 2 wiring.

(3) Input Wiring

SGR, SGRL: Use terminals ①, ④, ⑤ for the input wiring.

SGRW: Use terminals ①, ②, ④ for the input wiring.

(4) Communication Wiring

For the SGRL, connect the SGRL to SGRL using the provided cable.

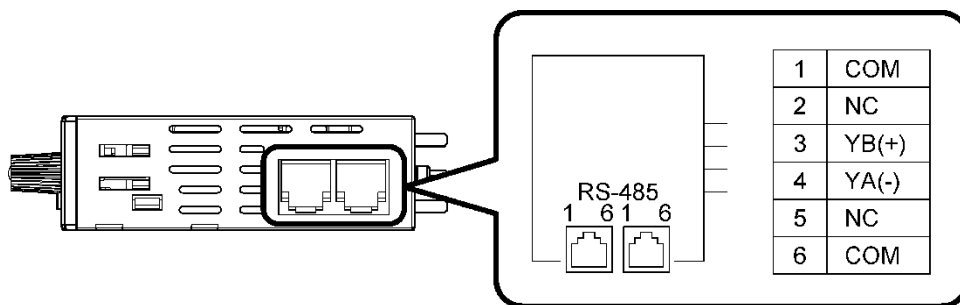

(Fig. 4.4-1)

5. Display Mode

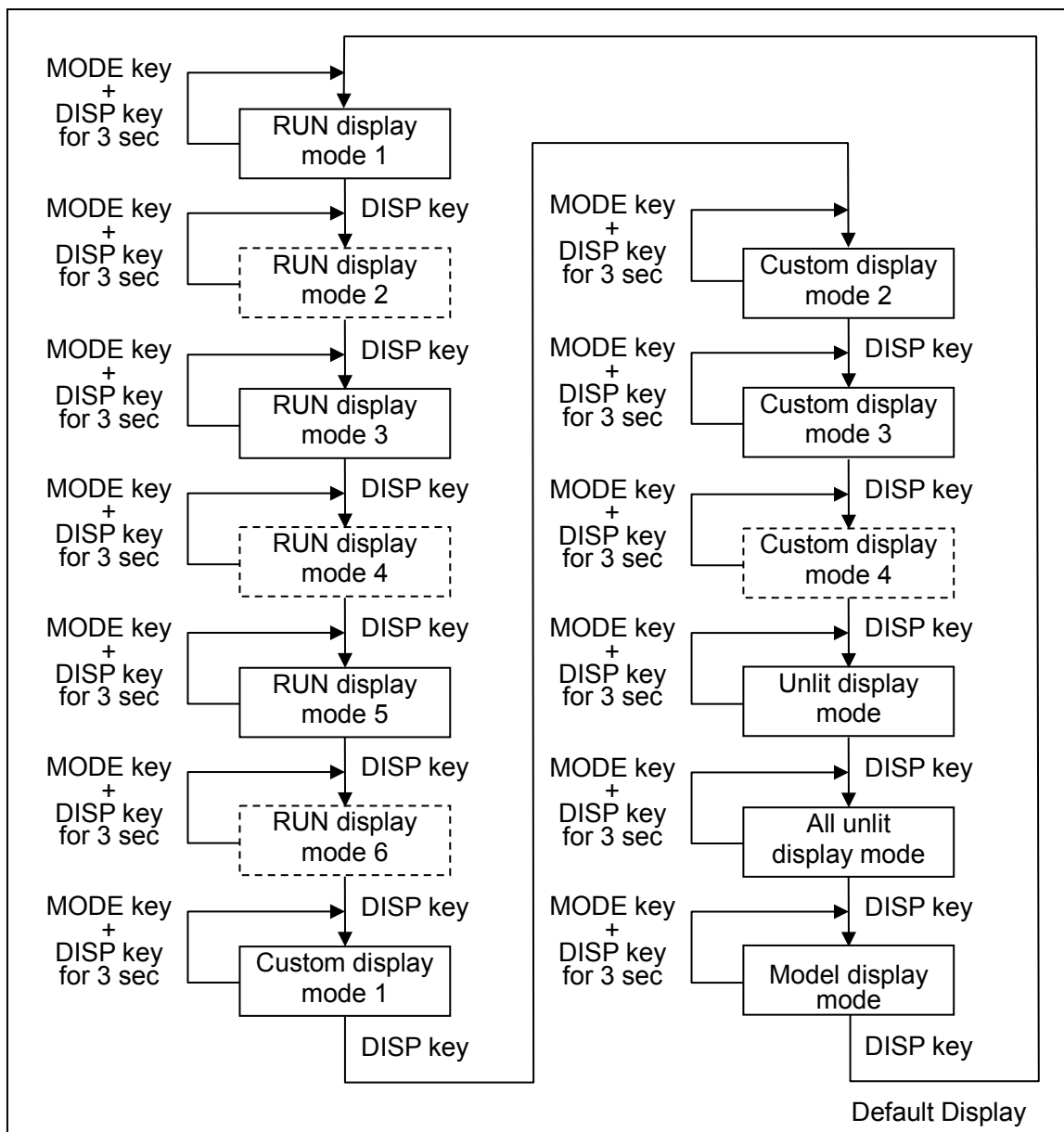

• [dashed box]: Available only for the SGRW.

Default Display:

If the MODE and DISP keys (in that order) are pressed together for approx. 3 seconds in any display mode, the display mode will become the Default Display.

Once the Default Display is set, the DISP key will be in lock status. If the DISP key is pressed for approx. 3 seconds on the Default Display, the key lock status will be cancelled.

If the DISP key is pressed while the DISP key is in lock status, Multi-Display A indicates **LOCK**.

- RUN display mode 1:** Multi-Display A indicates the input value, and Multi-Display B indicates Output 1 value.
- RUN display mode 2:** Multi-Display A indicates the input value, and Multi-Display B indicates Output 2 value.
- RUN display mode 3:** Multi-Display A indicates the input value, and Multi-Display B is unlit.
- RUN display mode 4:** Multi-Display A indicates Output 1 value, and Multi-Display B indicates Output 2 value.
- RUN display mode 5:** Multi-Display A is unlit, and Multi-Display B indicates Output 1 value.
- RUN display mode 6:** Multi-Display A is unlit, and Multi-Display B indicates Output 2 value.
- Custom display mode 1:** Multi-Display A indicates characters set in [Multi-Display A]. Multi-Display B indicates characters set in [Multi-Display B].
- Custom display mode 2:** Multi-Display A indicates the input value, and Multi-Display B indicates characters set in [Multi-Display B].
- Custom display mode 3:** Multi-Display A indicates Output 1 value, and Multi-Display B indicates characters set in [Multi-Display B].
- Custom display mode 4:** Multi-Display A indicates Output 2 value, and Multi-Display B indicates characters set in [Multi-Display B].
- Unlit display mode:** Multi-Display A and B are unlit, and the Input indicator A lights up.
Alarm indicator A and B light up if they are under the conditions of lighting.
- All unlit display mode:** All displays and indicators are unlit.
Alarm indicator A and B do not light up even if they are under the conditions of lighting.
- Model display mode:** Multi-Display A indicates the model name, and Multi-Display B indicates an input code and output code.

6. Setting Mode

6.1 Display Transition in Setting Mode

- : Available only for the SGRW.
- : Available only for the SGRL.
- If the MODE key is pressed and held down for approx. 5 seconds in each setting mode, the unit will move to the Default Display.

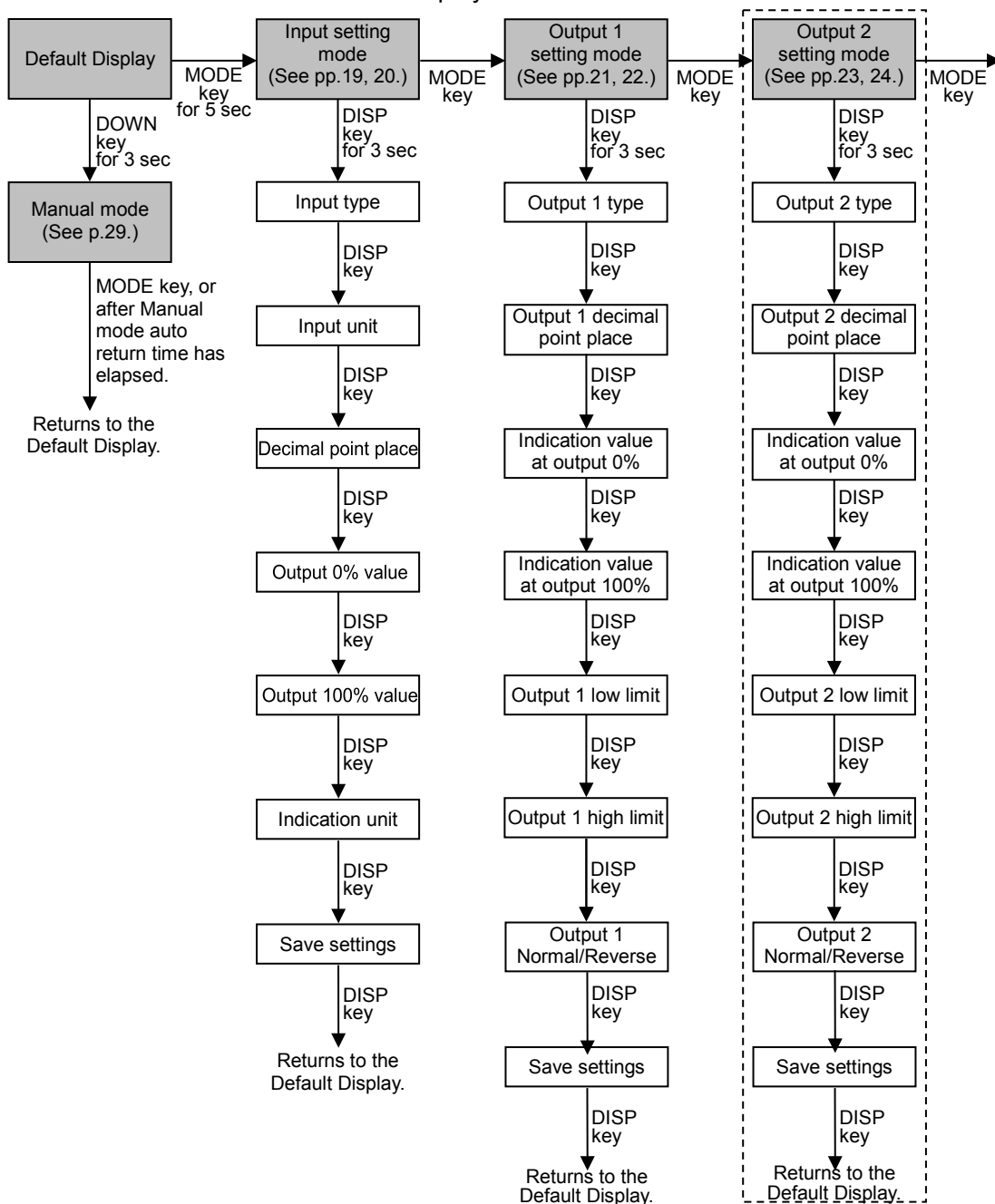

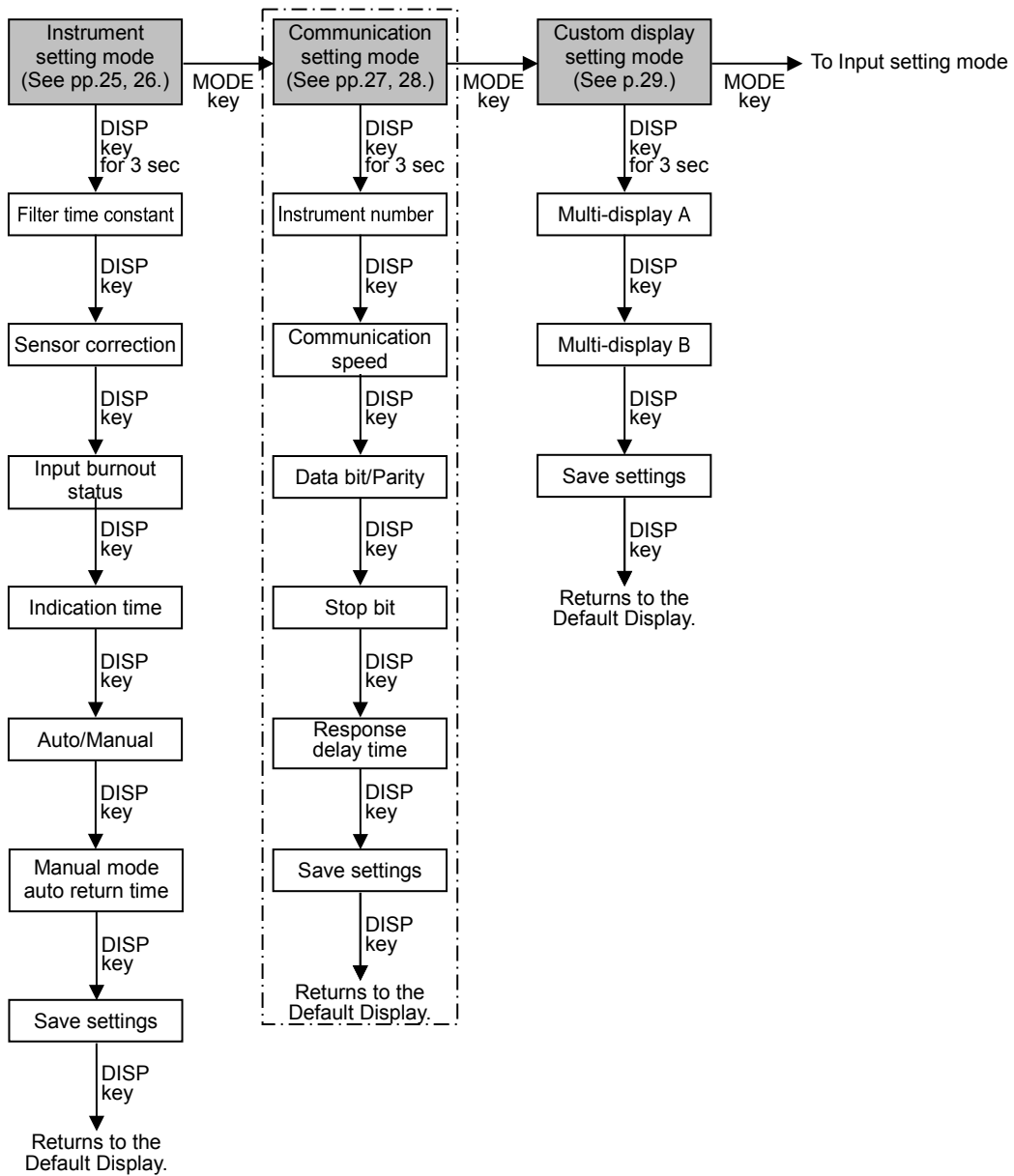

6.2 Input Setting Mode

Input Type

Selects an input type.

Setting Range	Indication		Factory Default
	Multi-Display A	Multi-Display B	
Pt100 -200 to 650 °C	Pt100	Pt100	Pt100 -200 to 650°C Pt100 Pt100
Pt100 -100 to 100 °C *		Pt100	
JPt100 -200 to 500 °C		JPt100	
JPt100 -100 to 100 °C *		JPt100	

* 'No decimal point' and '1 digit after decimal point' can be selected in [Decimal point place].

Input Unit

Selects an input temperature unit °C or °F.

Setting Range	Indication		Factory Default
	Multi-Display A	Multi-Display B	
°C	°C	°C	°C °C °C
°F		°F	

Decimal Point Place

Selects the decimal point place.

Setting Range	Indication		Factory Default
	Multi-Display A	Multi-Display B	
No decimal point	No decimal point	No decimal point	No decimal point No decimal point No decimal point
1 digit after decimal point		1 digit after decimal point	

Output 0% Value

Sets an input value (indicated on the display) at the time of output 0%.

Values change in accordance with the input unit.

Setting Range	Indication		Factory Default
	Multi-Display A	Multi-Display B	
Low limit of each input type to Output 100% value	Low limit of each input type to Output 100% value	Set value	-200 -200 -200

Output 100% Value

Sets an input value (indicated on the display) at the time of output 100%.

Values change in accordance with the input unit.

Setting Range	Indication		Factory Default
	Multi-Display A	Multi-Display B	
Output 0% value to High limit of each input type	Output 0% value to High limit of each input type	Set value	650 650 650

Indication Unit

Selects the unit for indication.

Setting Range	Indication		Factory Default
	Multi-Display A	Multi-Display B	
No unit	NONE	NONE	No unit NONE NONE
%		PER	
mA		MA	
V		VOL	
°C		CELS	

Save Settings

Selects whether the settings are saved (registered) or not.

Setting Range	Indication		Factory Default
	Multi-Display A	Multi-Display B	
Save	SAVE	YES	Save SAVE YES
Not save		NO	

6.3 Output 1 Setting Mode

Output 1 Type

Selects an output type.

Setting Range	Indication		Factory Default
	Multi-Display A	Multi-Display B	
4 to 20 mA			4 to 20 mA
0 to 20 mA			
0 to 16 mA			
2 to 10 mA			
0 to 10 mA			
0 to 10 mV			
0 to 100 mV			
0 to 1 V			
0 to 5 V			
1 to 5 V			
0 to 10 V			
-5 to 5 V *			

* Not available for the SGRW.

Output 1 Decimal Point Place

Selects the decimal point place for Output 1.

Setting Range	Indication		Factory Default
	Multi-Display A	Multi-Display B	
No decimal point			2 digits after decimal point
1 digit after decimal point			
2 digits after decimal point			
3 digits after decimal point			

Indication Value at Output 0%

Sets an indication value at the time of output 0%.

Setting Range	Indication		Factory Default
	Multi-Display A	Multi-Display B	
-1999 to 9999		Set value	4.00

Indication Value at Output 100%

Sets an indication value at the time of output 100%.

Setting Range	Indication		Factory Default
	Multi-Display A	Multi-Display B	
-1999 to 9999		Set value	20.00

Output 1 Low Limit

Sets Output 1 low limit value.

Setting Range	Indication		Factory Default
	Multi-Display A	Multi-Display B	
-10.0 to Output 1 high limit	OLLM	Set value	-10.0% OLLM HI00

Output 1 High Limit

Sets Output 1 high limit value.

Setting Range	Indication		Factory Default
	Multi-Display A	Multi-Display B	
Output 1 low limit to 110.0	OLHM	Set value	110.0% OLHM HI00

Output 1 Normal/Reverse

Selects either Normal mode or Reverse mode for Output 1 status.

Setting Range	Indication		Factory Default
	Multi-Display A	Multi-Display B	
Normal	OLNM	NOML	Normal OLNM NOML
Reverse		REKS	

Save Settings

Selects whether the settings are saved (registered) or not.

Setting Range	Indication		Factory Default
	Multi-Display A	Multi-Display B	
Save	SAKE	YESX	Save SAKE YESX
Not save		NOXX	

6.4 Output 2 Setting Mode

Available only for the SGRW.

Output 2 Type

Selects an output type.

Setting Range	Indication		Factory Default
	Multi-Display A	Multi-Display B	
4 to 20 mA			4 to 20 mA
0 to 20 mA			
0 to 16 mA			
2 to 10 mA			
0 to 10 mA			
0 to 10 mV			
0 to 100 mV			
0 to 1 V			
0 to 5 V			
1 to 5 V			
0 to 10 V			

Output 2 Decimal Point Place

Selects a decimal point place for Output 2.

Setting Range	Indication		Factory Default
	Multi-Display A	Multi-Display B	
No decimal point			2 digits after decimal point
1 digit after decimal point			
2 digits after decimal point			
3 digits after decimal point			

Indication Value at Output 0%

Sets an indication value at the time of output 0%.

Setting Range	Indication		Factory Default
	Multi-Display A	Multi-Display B	
-1999 to 9999		Set value	4.00

Indication Value at Output 100%

Sets an indication value at the time of output 100%.

Setting Range	Indication		Factory Default
	Multi-Display A	Multi-Display B	
-1999 to 9999		Set value	20.00

Output 2 Low Limit

Sets Output 2 low limit value.

Setting Range	Indication		Factory Default
	Multi-Display A	Multi-Display B	
-10.0 to Output 2 high limit	0002	Set value	-10.0% 0002 1100

Output 2 High Limit

Sets Output 2 high limit value.

Setting Range	Indication		Factory Default
	Multi-Display A	Multi-Display B	
Output 2 low limit to 110.0	0002	Set value	110.0% 0002 1100

Output 2 Normal/Reverse

Selects either Normal mode or Reverse mode for Output 2 status.

Setting Range	Indication		Factory Default
	Multi-Display A	Multi-Display B	
Normal	0002	N0ML	Normal 0002 N0ML
Reverse		REKS	

Save Settings

Selects whether the settings are saved (registered) or not.



Setting Range	Indication		Factory Default
	Multi-Display A	Multi-Display B	
Save	0002	YESX	Save 0002 YESX
Not save		NOXX	

6.5 Instrument Setting Mode

Filter Time Constant

Sets the input filter time constant.



Input fluctuation due to noise can be decreased.

Setting Range	Indication		Factory Default
	Multi-Display A	Multi-Display B	
0.0 to 10.0 seconds		Set value	0.0 sec 

Sensor Correction

Sets sensor correction value.





Input value = Current input value + (Sensor correction value)

Setting Range	Indication		Factory Default
	Multi-Display A	Multi-Display B	
-1000 to 1000 *		Set value	0 

* The placement of the decimal point follows the selection.

Input burnout Status

Selects either overscale or underscale when input is burnt out.



Setting Range	Indication		Factory Default
	Multi-Display A	Multi-Display B	
Overscale			Overscale 
Underscale			

Indication Time

Sets duration from no operation until indication (of Multi-Display A, Multi-Display B, and each action indicator) turns off.

When set to 00.00, they remain lit.

After indication time has elapsed, if any key is pressed while they are unlit, they will light up again.

Setting Range	Indication		Factory Default
	Multi-Display A	Multi-Display B	
00 : 00 to 60 : 00 (Minutes : Seconds) 00 : 00..... Continuous 00 : 01 to 60 : 00.. Indication time		Set value	30 : 00 (Minutes : Seconds) 

Auto/Manual

If AUTO is selected, the output value corresponding to the input value will be output. When MANUAL is selected, the unit can enter Manual mode. The output value set in Manual mode will be output.

Setting Range	Indication		Factory Default
	Multi-Display A	Multi-Display B	
Auto	MARS	AUTO	Manual MARS MANU
Manual		MANU	

Manual Mode Auto Return Time

Sets duration from manual mode until the unit automatically returns to the Default Display.

If set to 0 (zero), auto return will not occur.

Setting Range	Indication		Factory Default
	Multi-Display A	Multi-Display B	
0 to 60 minutes	MORE	Set value	30 minutes MORE 00

Save Settings

Selects whether the settings are saved (registered) or not.

Setting Range	Indication		Factory Default
	Multi-Display A	Multi-Display B	
Save	SAVE	YES	Save SAVE YES
Not save		NO	

6.6 Communication Setting Mode

Available only for the communication specifications.

Instrument Number

Sets the instrument number.

Setting Range	Indication		Factory Default
	Multi-Display A	Multi-Display B	
1 to 247		Set value	1

Communication Speed

Selects the communication speed.

Setting Range	Indication		Factory Default
	Multi-Display A	Multi-Display B	
9600 bps			38400 bps
19200 bps			
38400 bps			

Data bit/Parity

Selects data bit and parity.

Setting Range	Indication		Factory Default
	Multi-Display A	Multi-Display B	
8 bits/No parity			8 bits/Odd
8 bits/Even			
8 bits/Odd			

Stop Bit

Selects the stop bit.

Setting Range	Indication		Factory Default
	Multi-Display A	Multi-Display B	
1 bit			1 bit
2 bits			

Response Delay Time

Response from the instrument can be delayed after receiving command from the host computer.

Setting Range	Indication		Factory Default
	Multi-Display A	Multi-Display B	
0 to 1000 ms		Set value	10 ms

Save Settings

Selects whether the settings are saved (registered) or not.

Setting Range	Indication		Factory Default
	Multi-Display A	Multi-Display B	
Save	SAVE	YES	Save SAVE YES
Not save		NO	

6.7 Custom Display Setting Mode

Customizes characters to be indicated on the Multi-Display A and B*.

Use alphanumeric characters and symbols.

(e.g.) FLOW, TEMP, No.1, No.2

* Number of characters which can be indicated differs depending on the display mode.

Refer to Section '5. Display Mode' (pp.15, 16).

- If Custom display mode 1 is selected:
Up to 8 characters can be displayed in total for both Multi-Display A and B.
- If any of Custom display mode 2 to 4 is selected:
Up to 4 characters can be displayed on the Multi-Display B.

Can be set from the thousands digit of the display.

Digits can be selected with the MODE key.

Multi-Display A

Characters for the Multi-Display A can be customized.

Setting Range	Indication		Factory Default
	Multi-Display A	Multi-Display B	
A to Z, 0 to 9, /, -, ., (Blank)		Set value	

Multi-Display B

Characters for the Multi-Display B can be customized.

Setting Range	Indication		Factory Default
	Multi-Display A	Multi-Display B	
A to Z, 0 to 9, /, -, ., (Blank)		Set value	

Save Settings

Selects whether the settings are saved (registered) or not.

Setting Range	Indication		Factory Default
	Multi-Display A	Multi-Display B	
Save			Save
Not save			

6.8 Manual Mode

If MANUAL is selected in [Auto/Manual] in Instrument setting mode, then the unit can enter Manual mode.

At this time, Multi-Display A indicates Output 1 value, and Multi-Display B indicates Output 2 value. The output value can be set by the UP or DOWN key. The output value is lit while setting.

Pressing the DISP key switches the output to be set. The output to be set flashes.

By pressing the MODE key in Manual mode, or after Manual mode auto return time has elapsed, the unit returns to the Default Display, and outputs the value corresponding to the input value.

7. Adjustment

Performs the output zero and span adjustments.

For this instrument, the output adjustment has already been completed when shipped.

If the instrument is used with the ordered Input/Output spec, the adjustment is not required.

However, for calibration, or for the fine adjustment of the SGR to which any equipment is connected, perform the adjustment.

Connect an mV generator or Dial resistor to the input terminals of this instrument.

Connect a digital multimeter to the output terminals.

7.1 Basic Operation of Adjustment

Use the following trimmers on the front panel for adjustment.

Output 1 Zero: Adjusts the value of Output 1 Zero.

Output 1 Span: Adjusts the value of Output 1 Span.

Output 2 Zero: Adjusts the value of Output 2 Zero. (for SGRW only)

Output 2 Span: Adjusts the value of Output 2 Span. (for SGRW only)

7.2 Adjustment

All adjustment items are shown below.

Perform adjustment as follows.

7.2.1 Output 1 Adjustment

The following outlines the procedure for Output 1 adjustment.

- ① Enter the value corresponding to output 0%, and adjust the value using the 'Output 1 Zero' trimmer while viewing the output value (on the digital multimeter).
- ② Enter the value corresponding to output 100%, and adjust the value using the 'Output 1 Span' trimmer while viewing the output value (on the digital multimeter).
- ③ Enter the value corresponding to output 0% again, and confirm the output value (on the digital multimeter).
- ④ If the value corresponding to output 0% is not at 0%, repeat steps ① to ③ again.

7.2.2 Output 2 Adjustment

The procedure for Output 2 adjustment is the same as that of Output 1 adjustment.

Use Output 2 Zero and Span trimmers for adjustment.

8. Operation

8.1 Indication after Power-on

After the power is turned on, the instrument is switched to warm-up status for 3 seconds. Multi-Display A indicates the model name, and Multi-Display B indicates the input code and output code.

(e.g.) SGR-A01-0-0

Multi-Display A: 

Multi-Display B: 

A value corresponding to input 0% will be output for Output 1 and Output 2.

8.2 Operation

After warm-up indication, the unit enters display mode.

The input signal selected in [Input type] will be converted to the output selected in [Output 1 type] and [Output 2 type].

8.2.1 Input Indication Range

The measured value is indicated within the following range:

[Input range low limit – (Input span) ×10%] to

[Input range high limit + (Input span) ×10%]

However, if a range with a decimal point is selected: For a value lower than (and including) -200.0, the input value and the minus (-) sign will be indicated alternately.

When the measured value exceeds the indication range:  will flash.

When the measured value drops below the indication range:  will flash.

8.2.2 Indication Range of Output 1 and Output 2

The output value is indicated within the following range:

[Indication value at output 0% – (Indication value at output 100%– Indication value at output 0%)×10%] to

[Indication value at output 100% + (Indication value at output 100% – Indication value at output 0%)×10%]

However, the high limit value is 9999, and the low limit value is -1999.

(The placement of the decimal point follows the selection.)

8.2.3 Input Burnout Status

Overscale or underscale can be selected in the event of RTD input burnout.

If overscale is selected, the output is forcibly limited to 110%.

If underscale is selected, the output is forcibly limited to 0%.

When overscale is selected: If input is burnt out, the Alarm indicator will light up, and  will flash.

When underscale is selected: If input is burnt out, the Alarm indicator will light up, and  will flash.

8.2.4 Indication Time

After the duration set in [Indication time] has elapsed, Multi-Display A, Multi-Display B and each action indicator are turned OFF. They light up again if any key is pressed.

They remain lit during setting mode, or in the event of an input error or input burnout.

If the indication time is set to 00:00, they remain lit.

9. Specifications

Input Specifications

RTD input	Pt100, JPt100 3-wire type Input detection current: Approx. 200 μ A Allowable lead wire resistance: 200 Ω max. per wire Input:		
	RTD	Input Range *1	Indication Resolution
	Pt100	-200 to 650 $^{\circ}$ C (-328 to 1202 $^{\circ}$ F)	1 $^{\circ}$ C (1 $^{\circ}$ F)
		-100 to 100 $^{\circ}$ C*2 (-148 to 212 $^{\circ}$ F)*2	1 $^{\circ}$ C (1 $^{\circ}$ F)*2
	JPt100	-200 to 500 $^{\circ}$ C (-328 to 932 $^{\circ}$ F)	1 $^{\circ}$ C (1 $^{\circ}$ F)
-100 to 100 $^{\circ}$ C*2 (-148 to 212 $^{\circ}$ F)*2		1 $^{\circ}$ C (1 $^{\circ}$ F)*2	
*1: $^{\circ}$ C/ $^{\circ}$ F can be selected in [Input unit]. *2: 'No decimal point' and '1 digit after decimal point' can be selected in [Decimal point place].			

Output 1 Specifications

Direct current	Output Range	Allowable Load Resistance	Zero Adjustment Range	Span Adjustment Range
	4 to 20 mA	750 Ω max.	-5 to 5%	95 to 105%
	0 to 20 mA*	750 Ω max.		
	0 to 16 mA*	900 Ω max.		
	2 to 10 mA	1500 Ω max.		
	0 to 10 mA*	1500 Ω max.		
* 0 mA or less: Out of base accuracy				
DC voltage	Output Range	Allowable Load Resistance	Zero Adjustment Range	Span Adjustment Range
	0 to 10 mV*1	10 k Ω min.	-5 to 5%	95 to 105%
	0 to 100 mV*1	100 k Ω min.		
	0 to 1 V*1	1000 Ω min.		
	0 to 5 V*1	5000 Ω min.		
	1 to 5 V	5000 Ω min.		
	0 to 10 V*1	10 k Ω min.		
	-5 to 5 V*2	10 k Ω min.		
*1: 0 V or less: Out of base accuracy *2: Not available for the SGRW.				

Output 2 Specifications

Direct current	Output Range	Allowable Load Resistance	Zero Adjustment Range	Span Adjustment Range
	4 to 20 mA	750 Ω max.	-5 to 5%	95 to 105%
	0 to 20 mA *	750 Ω max.		
	0 to 16 mA *	900 Ω max.		
	2 to 10 mA	1500 Ω max.		
	0 to 10 mA *	1500 Ω max.		
* 0 mA or less: Out of base accuracy				
DC voltage	Output Range	Allowable Load Resistance	Zero Adjustment Range	Span Adjustment Range
	0 to 10 mV *	10 k Ω min.	-5 to 5%	95 to 105%
	0 to 100 mV *	100 k Ω min.		
	0 to 1 V *	1000 Ω min.		
	0 to 5 V *	5000 Ω min.		
	1 to 5 V	5000 Ω min.		
0 to 10 V *	10 k Ω min.			
* 0 V or less: Out of base accuracy				

Performance

Base accuracy (at 25°C)	$\pm 0.1\%$ of each input span
Cold junction compensation accuracy	$\pm 0.5^\circ\text{C}$ (1.0°F) at $20 \pm 10^\circ\text{C}$
Temperature coefficient	$\pm 0.015\ \%/^\circ\text{C}$ 0 to 10 mV output: 0.02 $\%/^\circ\text{C}$
Effect of allowable input lead wire resistance	Less than 20 Ω per wire: Base accuracy 20 Ω or more per wire: Base accuracy + 0.005 $\%/\Omega$
Response time	500 ms max. (0→90%)
Indication update cycle	125 ms
Insulation resistance	100 M Ω minimum, at 500 V DC
Dielectric strength	2.0 kV AC for 1 minute

General Structure

Dimensions	22.5 x 89 x 70 mm (W x H x D)
Weight	Approx. 77 g
Mounting	DIN rail
Case	Flame-resistant resin, Color: Black
Front panel	Polycarbonate

Installation Specifications

Power supply	100 to 240 V AC 50/60 Hz 24 V AC/DC 50/60 Hz
Allowable voltage range	100 to 240 V AC: 85 to 264 V AC 24 V AC/DC: 20 to 28 V AC/DC
Power consumption	100 to 240 V AC: Approx. 9 VA max. (SGRL: Approx. 10 VA max.) 24 V AC: Approx. 6 VA max. 24 V DC: Approx. 3 W max.
Ambient temperature	-10 to 55°C (Non-condensing, no icing)
Ambient humidity	35 to 85 %RH (Non-condensing)

Serial Communication (for SGRL)



Operation from an external computer	Reading and setting of various set values Reading of the input value and action status Function change.
Communication line	EIA RS-485
Communication method	Half-duplex communication
Communication speed	9600, 19200, 38400 bps (Selectable by keypad) (Factory default: 38400 bps)
Synchronization method	Start-stop synchronization
Communication protocol	Modbus RTU
Start bit	1 bit
Data bit	8 bits
Parity	Even/Odd/No parity (Selectable by keypad) (Factory default: Odd)
Stop bit	1 bit or 2 bits (Selectable by keypad) (Factory default: 1 bit)
Response delay time	Response from the instrument can be delayed after receiving command from the host computer. 0 to 1000 ms (Factory default: 10 ms)

Standard Function

Power failure countermeasure	The setting data is backed up in the non-volatile IC memory.
Self-diagnosis	The CPU is monitored by a watchdog timer, and if an abnormal status occurs, the instrument is switched to warm-up status, turning all outputs OFF.

10. Troubleshooting

10.1 Indication

Problem	Possible Cause	Solution
Multi-Display A or B flashes  or  when it indicates an input value.	The sensor may be burnt out.	Replace with a new sensor.
	Check whether the sensor is securely mounted to the input terminals of this instrument.	Connect the sensor terminals to the instrument input terminals securely.
	Check the input signal source.	Ensure that the input signal source works normally.
	Check whether codes (A, B, B) of RTD agree with the instrument terminals.	Wire them correctly.
Multi-Display A or B is irregular or unstable when it indicates an input value.	Check whether sensor input or unit (°C/°F) is correct.	Select the same sensor and unit (°C/°F) as those of currently used sensor.
	Sensor correction value is unsuitable.	Set it to a suitable value.
	AC leaks into the sensor circuit.	Use an ungrounded type sensor.
	There may be equipment that interferes with or makes noise near the instrument.	Keep the instrument clear of any potentially disruptive equipment.
Displays and indicators are unlit. If any key is pressed, they will light up.	The Indication Time (p.25) is set to any value other than 00 : 00. (Factory default is 30 : 00.)	To indicate continuously, set the Indication Time (p.25) to "00 : 00".

10.2 Key Operation

Problem	Possible Cause	Solution
If the DISP key is pressed, Multi-Display A shows  , and the display mode cannot be switched.	The DISP key is in locked status.	Press the DISP key for approx. 3 seconds to release the key lock.

10.3 Operation

Problem	Possible Cause	Solution
When Multi-Display A or B indicates an input value, the input value does not change.	The sensor may be out of order.	Replace with the new sensor.
	Check whether input and output wire are securely connected to the I/O terminals of the instrument.	Ensure that input and output wire are securely connected to the I/O terminals of the instrument.
	Check whether the wiring of input and output are correct.	Wire them correctly.
No output	Selections in [Output 1 type (p.21)], [Output 1 Normal/Reverse (p.22)], [Output 2 type (p.23)] or [Output 2 Normal/Reverse (p.24)] may be incorrect.	Make a correct selection in [Output 1 type (p.21)], [Output 1 Normal/Reverse (p.22)], [Output 2 type (p.23)] or [Output 2 Normal/Reverse (p.24)].

11. Character Table

Please use the following factory default values for your reference.

Display mode

Setting Item	Multi-Display A	Multi-Display B	Data
Default display mode	Follows currently indicated display mode.		
RUN display mode 1	Input value	Output 1 value	
RUN display mode 2 *	Input value	Output 2 value	
RUN display mode 3	Input value	Unlit	
RUN display mode 4 *	Output 1 value	Output 2 value	
RUN display mode 5	Unlit	Output 1 value	
RUN display mode 6 *	Unlit	Output 2 value	
Custom display mode 1	AAAA	AAAA	
Custom display mode 2	Input value	AAAA	
Custom display mode 3	Output 1 value	AAAA	
Custom display mode 4 *	Output 2 value	AAAA	
Model display mode	Model	Input, Output codes	

* Available only for the SGRW.

Setting mode

Setting Item	Multi-Display A	Multi-Display B	Data
Input setting mode	ANM	Unlit	
Output 1 setting mode	0001	Unlit	
Output 2 setting mode *	0002	Unlit	
Instrument setting mode	ANL	Unlit	
Communication setting mode	00MM	Unlit	
Custom display setting mode	00SE	Unlit	

* Available only for the SGRW.

Input setting mode

Setting Item	Multi-Display A	Multi-Display B	Data
Input type	PEM	PEME	
Input unit	0FSE	000E	
Decimal point place	0A00	0000	
Output 0% value	0000	0000	
Output 100% value	0000	0000	
Indication unit	UNNE	000E	
Save settings	SAVE	0000	

Output 1 setting mode

Setting Item	Multi-Display A	Multi-Display B	Data
Output 1 type	0000	0000	
Output 1 decimal point place	0A00	0000	
Indication value at output 0%	0000	0000	
Indication value at output 100%	0000	0000	
Output 1 low limit	0000	0000	
Output 1 high limit	0000	0000	
Output 1 Normal/Reverse	0A00	0000	
Save settings	SAVE	0000	

Output 2 setting mode

Setting Item	Multi-Display A	Multi-Display B	Data
Output 2 type	0000	4000	
Output 2 decimal point place	0000	0000	
Indication value at output 0%	0000	0000	
Indication value at output 100%	0000	0000	
Output 2 low limit	0000	0000	
Output 2 high limit	0000	0000	
Output 2 Normal/Reverse	0000	0000	
Save settings	SAVE	YES	

Instrument setting mode

Setting Item	Multi-Display A	Multi-Display B	Data
Filter time constant	0000	0000	
Sensor correction	0000	0000	
Input burnout status	BURN	0000	
Indication time	0000	0000	
Auto/Manual	MANU	MANU	
Manual mode auto return time	0000	0000	
Save settings	SAVE	YES	

Communication setting mode (for SGRL)

Setting Item	Multi-Display A	Multi-Display B	Data
Instrument number	0000	0000	
Communication speed	0000	0000	
Data bit/Parity	0000	0000	
Stop bit	0000	0000	
Response delay time	0000	0000	
Save settings	SAVE	YES	

Custom display setting mode

Setting Item	Multi-Display A	Multi-Display B	Data
Multi-Display A	0000	0000	
Multi-Display B	0000	0000	
Save settings	SAVE	YES	

***** Inquiries *****

For any inquiries about this unit, please contact our agency or the vendor where you purchased the unit after checking the following.

[Example]

- Model ----- SGR-P011-0-0
- Serial number ----- 154F05000

In addition to the above, please let us know the details of the malfunction, or discrepancy, and the operating conditions.

SHINKO TECHNOS CO., LTD.
OVERSEAS DIVISION

Head Office: 2-5-1, Senbahigashi, Minoo, Osaka, Japan

URL: <http://www.shinko-technos.co.jp/e/>

Tel : +81-72-727-6100

E-mail: overseas@shinko-technos.co.jp

Fax: +81-72-727-7006