

Plug-in Type
Digital Indicating Resistivity Meter
WIL-102-SE
Instruction Manual

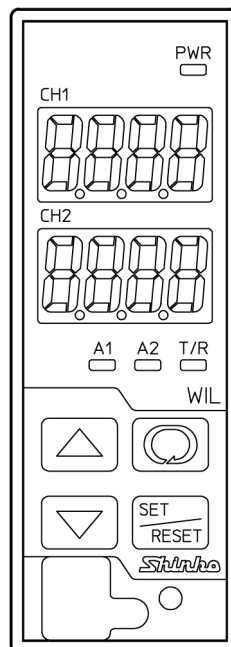

Shinko

Preface

Thank you for purchasing our WIL-102-SE, Plug-in Type Digital Indicating Resistivity Meter.

This manual contains instructions for the mounting, functions, operations and notes when operating the WIL-102-SE. To ensure safe and correct use, thoroughly read and understand this manual before using this instrument.

To prevent accidents arising from the misuse of this instrument, please ensure the operator receives this manual.

Characters Used in This Manual

Indication	4	0	1	2	3	4	5	6	7	8	9	℃	℉
Number, °C/°F	-1	0	1	2	3	4	5	6	7	8	9	°C	°F
Indication	A	b	c	d	E	F	G	H	I	J	k	L	M
Alphabet	A	B	C	D	E	F	G	H	I	J	K	L	M
Indication	n	o	P	q	r	s	T	U	v	w	x	y	z
Alphabet	N	O	P	Q	R	S	T	U	V	W	X	Y	Z

Caution

- This instrument should be used in accordance with the specifications described in the manual. If it is not used according to the specifications, it may malfunction or cause a fire.
- Be sure to follow all of the warnings, cautions and notices. If they are not observed, serious injury or malfunction may occur.
- The contents of this instruction manual are subject to change without notice.
- Care has been taken to ensure that the contents of this instruction manual are correct, but if there are any doubts, mistakes or questions, please inform our sales department.
- This instrument is designed to be installed on a DIN rail within a control panel. If it is not, measures must be taken to ensure that the operator cannot touch power terminals or other high voltage sections.
- Any unauthorized transfer or copying of this document, in part or in whole, is prohibited.
- Shinko Technos Co., Ltd. is not liable for any damage or secondary damage(s) incurred as a result of using this product, including any indirect damage.

Safety Precautions (Be sure to read these precautions before using our products.)

The safety precautions are classified into 2 categories: "Warning" and "Caution". Depending on the circumstances, procedures indicated by  Caution may result in serious consequences, so be sure to follow the directions for usage.

Warning

Procedures which may lead to dangerous conditions and cause death or serious injury, if not carried out properly.

Caution

Procedures which may lead to dangerous conditions and cause superficial to medium injury or physical damage or may degrade or damage the product, if not carried out properly.

Warning

- To prevent an electrical shock or fire, only Shinko or other qualified service personnel may handle the inner assembly.
- To prevent an electrical shock, fire or damage to the instrument, parts replacement may only be undertaken by Shinko or other qualified service personnel.

SAFETY PRECAUTIONS

- To ensure safe and correct use, thoroughly read and understand this manual before using this instrument.
 - This instrument is intended to be used for measuring equipment. Verify correct usage after purpose-of-use consultation with our agency or main office. (Never use this instrument for medical purposes with which human lives are involved.)
 - External protection devices such as protective equipment against excessive temperature rise, etc. must be installed, as malfunction of this product could result in serious damage to the system or injury to personnel. Proper periodic maintenance is also required.
 - This instrument must be used under the conditions and environment described in this manual.
- Shinko Technos Co., Ltd. does not accept liability for any injury, loss of life or damage occurring due to the instrument being used under conditions not otherwise stated in this manual.

Caution with Respect to Export Trade Control Ordinance

To avoid this instrument from being used as a component in, or as being utilized in the manufacture of weapons of mass destruction (i.e. military applications, military equipment, etc.), please investigate the end users and the final use of this instrument. In the case of resale, ensure that this instrument is not illegally exported.

PRECAUTIONS

1. Installation Precautions

Caution

This instrument is intended to be used under the following environmental conditions (IEC61010-1):

- Overvoltage category II, Pollution degree 2

Ensure the mounting location corresponds to the following conditions:

- A minimum of dust, and an absence of corrosive gases
- No flammable, explosive gases
- No mechanical vibrations or shocks
- No exposure to direct sunlight, an ambient temperature of 0 to 50°C (32 to 122°F) that does not change rapidly, and no icing
- An ambient non-condensing humidity of 35 to 85 %RH
- No large capacity electromagnetic switches or cables through which large current is flowing
- No water, oil, chemicals or the vapors of these substances can come into direct contact with the unit.
- If the WIL-102-SE is installed within a control panel, the ambient temperature of the unit – not the ambient temperature of the control panel – must be kept under 50°C. Otherwise the life of electronic parts (especially electrolytic capacitors) of the unit will be shortened.

Note: Do not install this instrument on or near flammable material even though the case of this instrument is made of flame-resistant resin.

2. Wiring Precautions

Caution

- Do not leave wire remnants in the instrument, as they could cause a fire or a malfunction.
- Use a solderless terminal with an insulation sleeve in which the M3 screw fits when wiring the WIL-102-SE.
- Tighten the terminal screw using the specified torque. If excessive force is applied to the screw when tightening, the terminal screw may be damaged.
- This instrument does not have a built-in power switch, circuit breaker and fuse.
It is necessary to install a power switch, circuit breaker and fuse near the instrument.
(Recommended fuse: Time-lag fuse, rated voltage 250 V AC, rated current 2 A)
- For a 24 V AC/DC power source, do not confuse polarity when using direct current (DC).
- Do not apply a commercial power source to the sensor which is connected to the input terminal nor allow the power source to come into contact with the sensor.
- Use the 2-electrode Resistivity Sensor in accordance with the sensor input specifications of the WIL-102-SE.
- Keep the input wires and power lines separate.

Note about the 2-Electrode Resistivity Sensor Cable

The 2-electrode Resistivity Sensor cable is a highly-insulated (electrical) cable. Please handle it with utmost care as follows.

- Do not allow terminals and socket of the 2-electrode Resistivity Sensor cable to come in contact with moisture or oil of any kind. Likewise, ensure fingers are clean, otherwise the insulation will deteriorate, resulting in unstable indication.
Be sure to keep the cable dry and clean at all times.
If the cable is stained, clean it with alcohol, and dry it completely.
- For calibration or electrode checking/replacement, the 2-electrode Resistivity Sensor cable should be wired with sufficient length.
- Keep the 2-electrode Resistivity Sensor cable and junction cable away from electrical devices, such as motors or their power lines from which inductive interference emanates.

Connection

The 2-electrode Resistivity Sensor cable has the following terminals.

Code	Terminal
1	Resistivity sensor terminal 2
2	Resistivity sensor terminal 3
A, B (T, T)	Temperature compensation sensor terminals [Pt100 (2-wire type), Pt1000] 5 - 6
A, B, B	Temperature compensation sensor terminals [Pt100 (3-wire type)] 5 - 6 - 7
E	Shield wire terminal 8

For the electrode with No Temperature Compensation, A, B (T, T) or A, B, B cables are not available. E cables are available depending on the sensor type.

During operation, the Resistivity/Temperature Display may become abnormal or unstable due to inductive interference or noise. In this case, try [Grounding of shield wire terminal (E) (P.72)].

3. Operation and Maintenance Precautions

Caution

- Do not touch live terminals. This may cause an electrical shock or problems in operation.
- Turn the power supply to the instrument OFF when retightening the terminal or cleaning.
Working on or touching the terminal with the power switched ON may result in severe injury or death due to electrical shock.
- Use a soft, dry cloth when cleaning the instrument.
(Alcohol based substances may tarnish or deface the unit.)
- As the display section is vulnerable, be careful not to put pressure on, scratch or strike it with a hard object.

Contents

1. Model.....	7
1.1 Model.....	7
1.2 How to Read the Model Label	7
2. Names and Functions of Instrument.....	8
3. Mounting to the Control Panel	9
3.1 Site Selection	9
3.2 External Dimensions (Scale: mm)	9
3.3 Mounting.....	9
4. Removal	11
5. Wiring	12
5.1 Lead Wire Solderless Terminal	13
5.2 Terminal Arrangement.....	13
5.3 Wire the Communication Line.....	14
6. Outline of Key Operation and Setting Groups	16
6.1 Outline of Key Operation	16
6.2 Setting Groups.....	16
7. Key Operation Flowchart.....	18
8. Setup	20
8.1 Turn the Power Supply ON.....	20
8.2 Resistivity Input Group	20
8.3 Temperature Input Group.....	28
8.4 Basic Function Group	30
9. Calibration	38
9.1 Resistivity Calibration Span Adjustment Mode	38
9.2 Temperature Calibration Mode	38
9.3 Transmission Output 1 Adjustment Mode	39
9.4 Transmission Output 2 Adjustment Mode	40
10. Measurement	41
10.1 Starting Measurement	41
10.2 A□□ Output.....	41
10.3 Resistivity Input Error Alarm	42
10.4 Error Output.....	42
10.5 Fail Output.....	42
10.6 Error Code during Measurement	42
10.7 Transmission Output 1 and 2.....	42
11. Communication.....	43
11.1 System Configuration Example.....	43
11.2 Setting Method of This Instrument	44
11.3 Communication Procedure	45
11.4 Shinko Protocol	46
11.4.1 Transmission Mode.....	46
11.4.2 Command Configuration.....	46
11.4.3 Checksum Calculation	47
11.5 MODBUS Protocol.....	48
11.5.1 Transmission Mode.....	48
11.5.2 Data Communication Interval.....	48
11.5.3 Message Configuration	48
11.5.4 Message Example	50
11.6 Communication Command Table	52
11.6.1 Notes about Setting/Reading Command.....	52
11.6.2 Setting/Reading Command.....	53
11.6.3 Read Only Command	59

11.7 Resistivity Calibration Span Adjustment and Temperature Calibration, Transmission Output.....	61
1 and 2 Adjustments via Communication Command	61
11.7.1 Resistivity Calibration Span Adjustment	61
11.7.2 Temperature Calibration	61
11.7.3 Transmission Output 1 Adjustment.....	62
11.7.4 Transmission Output 2 Adjustment.....	62
11.8 Notes on Programming Monitoring Software	63
11.8.1 How to Speed up the Scan Time	63
11.8.2 How to Read the Set Value Changes Made by Front Keypad Operation.....	63
11.8.3 Note when Sending All Set Values Simultaneously	63
12. Specifications	64
12.1 Standard Specifications.....	64
12.2 Optional Specifications	69
13. Troubleshooting	72
13.1 Indication	72
13.2 Key Operation.....	73
13.3 Communication.....	73
14. Temperature Compensation Method	74
14.1 How to Input Temperature Coefficient.....	74
14.2 Temperature Compensation Based on the Temperature Characteristics of Deionized Water.....	75
15. Character Tables	76

1. Model

1.1 Model

WIL-10	2	-SE		, □□□	
Input points	2				2 points
Input	SE				2-electrode Resistivity Sensor (Temperature element: Pt100) (*1)
					2-electrode Resistivity Sensor (Temperature element: Pt1000) (*1)
Power supply voltage	1				100 to 240 V AC (standard)
					24 V AC/DC (*2)
Option				EVT	A□□ output (A11, A12, A21, A22)
				TA	Transmission output 1 (*3)
				TA2	Transmission output 1, Transmission output 2

(*1) This input temperature specification was specified at the time of ordering.

(*2) Power supply voltage 100 to 240 V AC is standard.

When ordering 24 V AC/DC, enter "1" in Power supply voltage, after 'SE'.

(*3) If TA option is ordered, the EVT option (A1 output only) will be automatically added.

1.2 How to Read the Model Label

The model label is attached to the left side of the case.

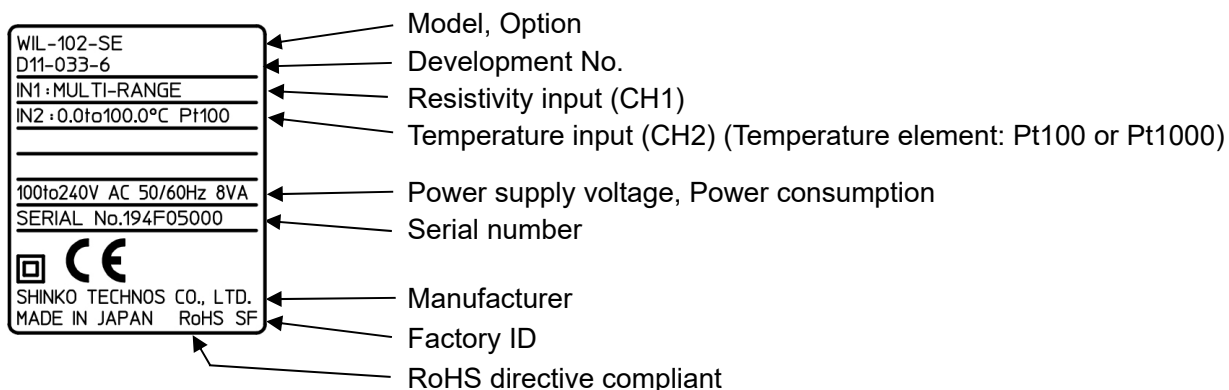

(Fig. 1.2-1)

2. Names and Functions of Instrument

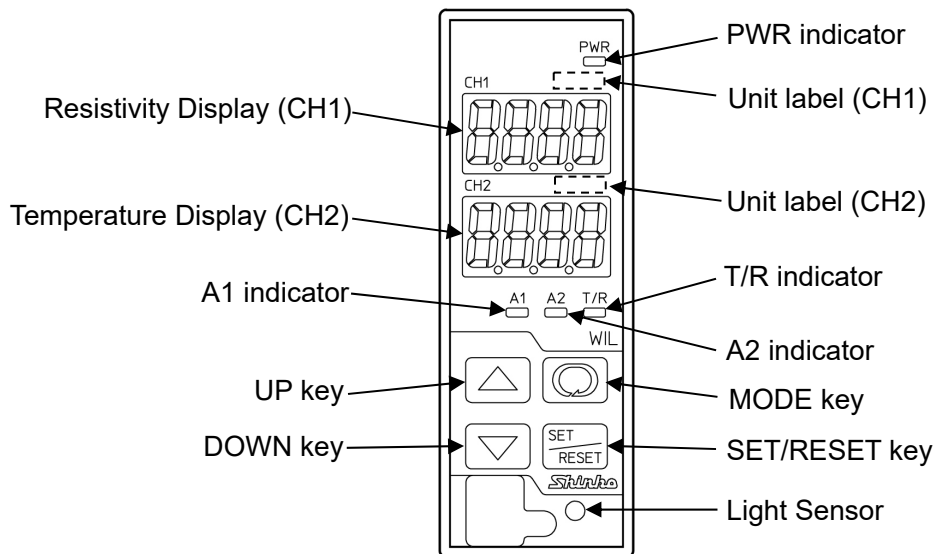

(Fig. 2-1)

Displays

Resistivity Display (CH1)	Resistivity or characters in setting mode are indicated in red. Indications differ depending on the selections in [Display selection (p.33)].
Temperature Display (CH2)	Temperature or values in setting mode are indicated in red. Indications differ depending on the selections in [Display selection (p.33)].





Unit label

Unit label (CH1)	Attach the user's unit of Resistivity Display (CH1) from the included unit labels if necessary.
Unit label (CH2)	Attach the user's unit of Temperature Display (CH2) from the included unit labels if necessary.

Action indicators

PWR indicator	When power supply to the instrument is turned ON, the yellow LED lights up.
A1 indicator	When either A1 output (Contact output 1) is ON, the red LED lights up. (If the TA2 option is ordered, it turns off.)
A2 indicator	When either A2 output (Contact output 2) is ON, the yellow LED lights up. (If the TA or TA2 option is ordered, it turns off.)
T/R indicator	The yellow LED lights up during Serial communication TX output (transmitting).

Keys

 UP key	Increases the numeric value.
 DOWN key	Decreases the numeric value.
 MODE key	Selects a setting group.
 SET/RESET key	Switches the setting modes, and registers the set value.

Light Sensor:	Automatically measures and controls brightness of the Resistivity Display (CH1), Temperature Display (CH2) and Action indicators.
----------------------	---

Notice

When setting the specifications and functions of this instrument, connect mains power cable to terminals 13 and 14 first, then set them referring from "6. Outline of Key Operation and Setting Groups" to "8. Setup (pages 16 to 37)" before "3. Mounting to the Control Panel (p.9)" and "5. Wiring (p.12)".

3. Mounting to the Control Panel

3.1 Site Selection

Caution

Use within the following temperature and humidity ranges.

Temperature: 0 to 50°C (32 to 122°F) (No icing), Humidity: 35 to 85 %RH (Non-condensing)

If the WIL-102-SE is installed within a control panel, the ambient temperature of the unit – not the ambient temperature of the control panel – must be kept under 50°C. Otherwise the life of electronic parts (especially electrolytic capacitors) of the unit will be shortened.

This instrument is intended to be used under the following environmental conditions.

(IEC61010-1): Overvoltage category II, Pollution degree 2

Ensure the mounting location corresponds to the following conditions:

- A minimum of dust, and an absence of corrosive gases
- No flammable, explosive gases
- No mechanical vibrations or shocks
- No exposure to direct sunlight, an ambient temperature of 0 to 50°C (32 to 122°F) that does not change rapidly
- An ambient non-condensing humidity of 35 to 85 %RH
- No large capacity electromagnetic switches or cables through which large current is flowing
- No water, oil, chemicals or the vapors of these substances can come into direct contact with the unit.

3.2 External Dimensions (Scale: mm)

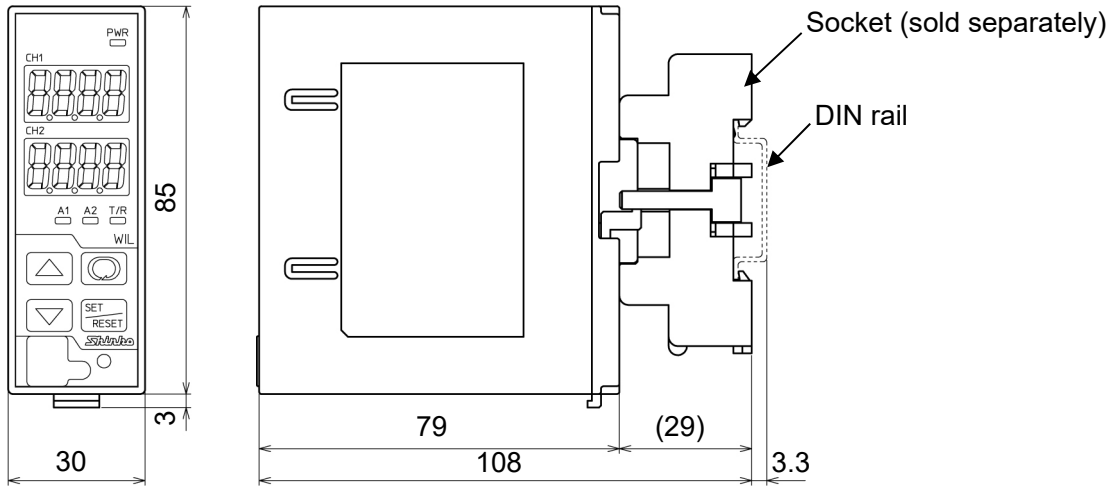

(Fig. 3.2-1)

3.3 Mounting

(1) Hook the upper part of the socket on the DIN rail, and mount it (A clicking sound is heard).

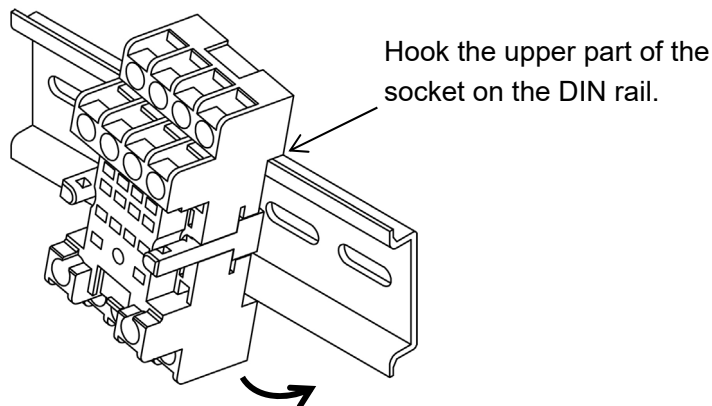

(Fig. 3.3-1)

Caution

Before inserting the WIL-102-SE into the socket, wire the unit while referring to Section “5. Wiring” (p.12).

(2) Check that the Lock Release has been lowered.

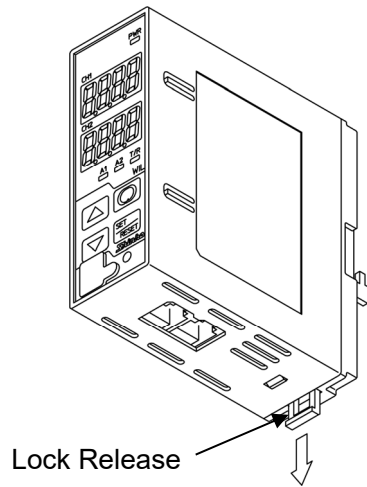

(Fig. 3.3-2)

(3) Insert the WIL-102-SE into the socket.

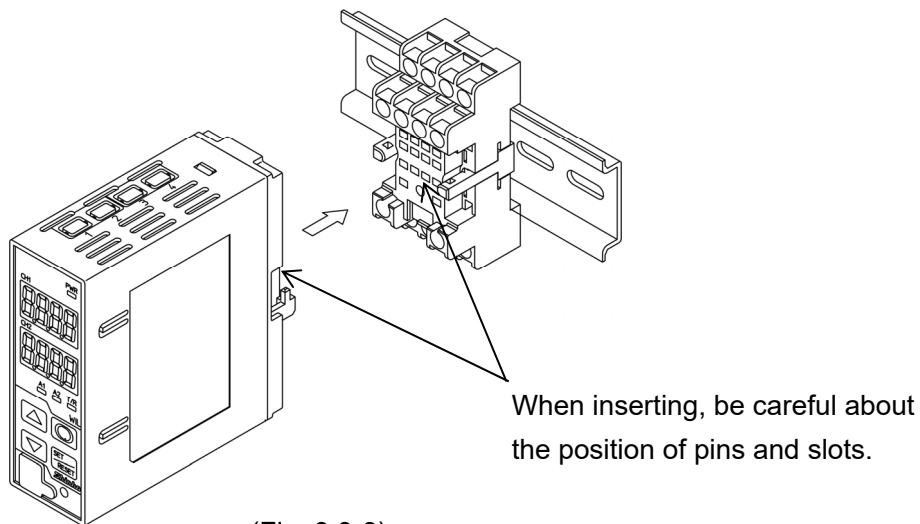

(Fig. 3.3-3)

(4) Fix the WIL-102-SE and the socket by pushing the Lock Release up.

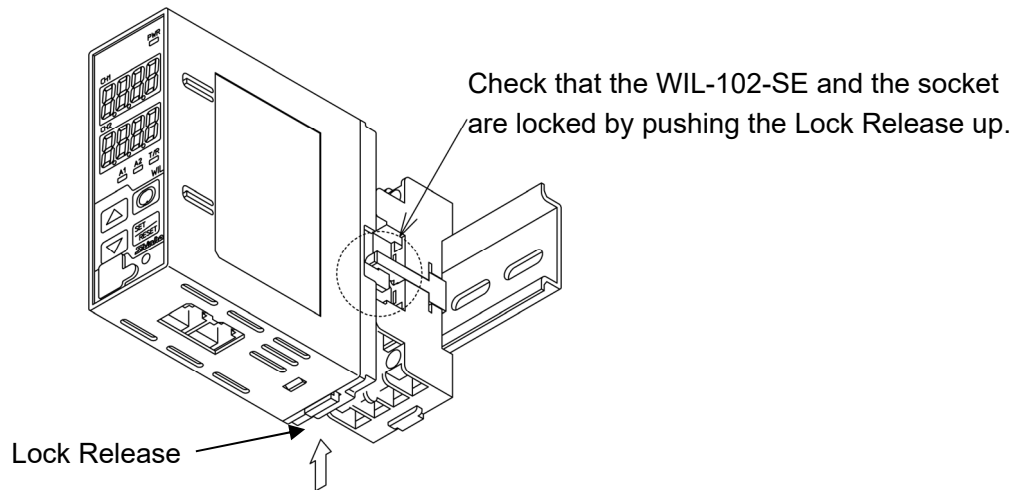

(Fig. 3.3-4)

4. Removal

- (1) Turn the power supply to the unit OFF.
- (2) Pull the Lock Release down, and release the WIL-102-SE from the socket.

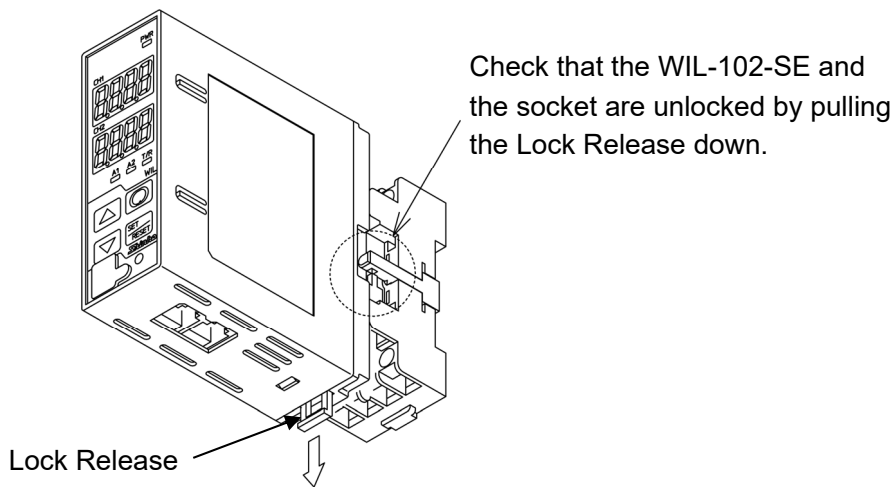

(Fig. 4-1)

- (3) Separate the WIL-102-SE from the socket.

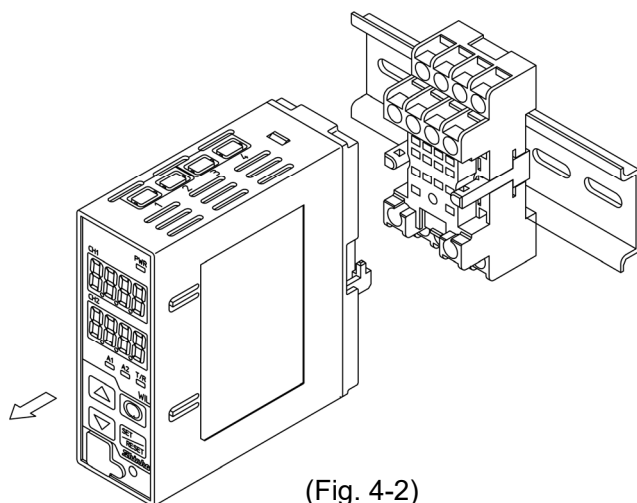

(Fig. 4-2)

- (4) Remove the socket from the DIN rail by pulling the socket Lock Release (at the bottom of the socket) down.

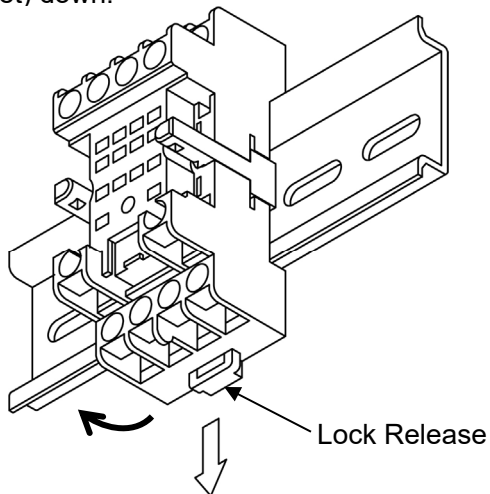

(Fig. 4-3)

5. Wiring

Warning

Turn the power supply to the instrument off before wiring or checking.
Working on or touching the terminal with the power switched on may result in severe injury or death due to electrical shock.

Caution

- Do not leave wire remnants in the instrument, as they could cause a fire or a malfunction.
- Use a solderless terminal with an insulation sleeve in which the M3 screw fits when wiring the WIL-102-SE.
- Tighten the terminal screw using the specified torque. If excessive force is applied to the screw when tightening, the terminal screw may be damaged.
- This instrument does not have a built-in power switch, circuit breaker and fuse. It is necessary to install a power switch, circuit breaker and fuse near the instrument.
(Recommended fuse: Time-lag fuse, rated voltage 250 V AC, rated current 2 A)
- For a 24 V AC/DC power source, do not confuse polarity when using direct current (DC).
- Do not apply a commercial power source to the sensor which is connected to the input terminal nor allow the power source to come into contact with the sensor.
- Use the 2-electrode Resistivity Sensor in accordance with the sensor input specifications of this unit.
- Keep the input wires and power lines separate.

Note about the 2-Electrode Resistivity Sensor Cable

The 2-electrode Resistivity Sensor cable is a highly-insulated (electrical) cable. Please handle it with utmost care as follows.

- Do not allow terminals and socket of the 2-electrode Resistivity Sensor cable to come in contact with moisture or oil of any kind. Likewise, ensure fingers are clean, otherwise the insulation will deteriorate, resulting in unstable indication. Be sure to keep the cable dry and clean at all times.
If the cable is stained, clean it with alcohol, and dry it completely.
- For calibration or electrode checking/replacement, the 2-electrode Resistivity Sensor cable should be wired with sufficient length.
- Keep the 2-electrode Resistivity Sensor cable and junction cable away from electrical devices, such as motors or their power lines from which inductive interference emanates.

Connection

The 2-electrode Resistivity Sensor cable has the following terminals.

Code	Terminal
1	Resistivity sensor terminal 2
2	Resistivity sensor terminal 3
A, B (T, T)	Temperature compensation sensor terminals (2-wire type) 5 – 6
A, B, B	Temperature compensation sensor terminals (3-wire type) 5 – 6 – 7
E	Shield wire terminal 8

For the electrode with No Temperature Compensation, A, B (T, T) or A, B, B cables are not available. E cables are available depending on the sensor type.

During operation, the Resistivity/Temperature Display may become abnormal or unstable due to inductive interference or noise. In this case, try [Grounding of shield wire terminal (E) (P.72)].

5.1 Lead Wire Solderless Terminal

Use a solderless terminal with an insulation sleeve in which an M3 screw fits as follows.

For the sockets with finger-safe & screw fall prevention functions, the ring-type terminals are unusable.

The tightening torque should be 0.63 N·m.

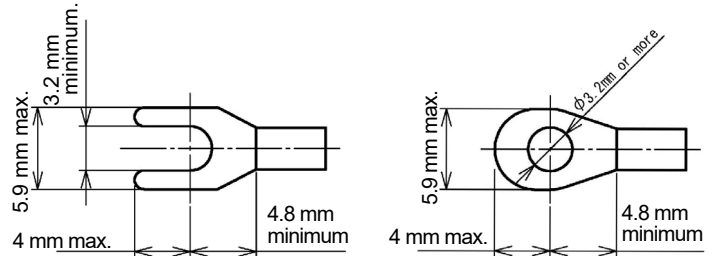

(Fig. 5.1-1)

Solderless Terminal	Manufacturer	Model
Y-type	Nichifu Terminal Industries CO.,LTD.	TMEV1.25Y-3S
Ring-type	Nichifu Terminal Industries CO.,LTD.	TMEV1.25-3
	Japan Solderless Terminal MFG CO.,LTD.	V1.25-3

5.2 Terminal Arrangement

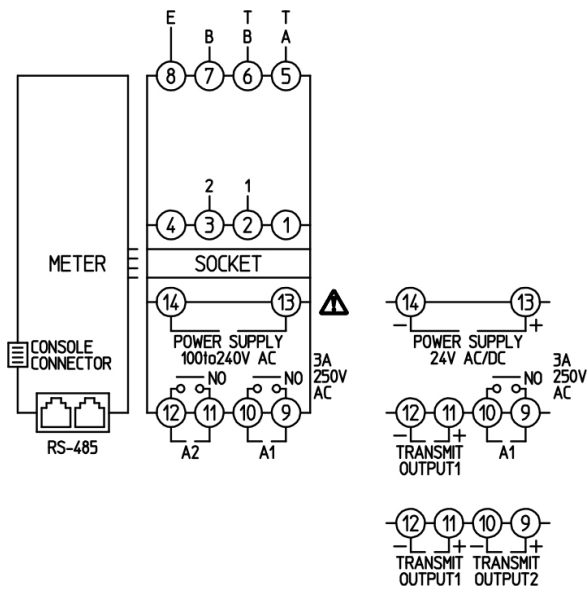

- 1, 2: Resistivity Sensor terminals 1, 2 (② - ③)
- A, B (T, T): Temperature compensation sensor terminals (⑤ - ⑥)
Temperature element: Pt100 (2-wire), Pt1000
- A, B, B: Temperature compensation sensor terminals (⑤ - ⑥ - ⑦)
Temperature element: Pt100 (3-wire)
- E: Shield wire terminal (⑧)
- When EVT option is ordered:
 - A1: A1 output terminals (⑨ - ⑩)
 - A2: A2 output terminals (⑪ - ⑫)
- When TA option is ordered:
 - A1: A1 output terminals (⑨ - ⑩)
 - TRANSMIT OUTPUT1: Transmission output 1 terminals (⑪ - ⑫)
- When TA2 option is ordered:
 - TRANSMIT OUTPUT2: Transmission output 2 terminals (⑨ - ⑩)
 - TRANSMIT OUTPUT1: Transmission output 1 terminals (⑪ - ⑫)
- POWER SUPPLY: Power terminals (⑬ - ⑭)
24V AC/DC (1 is entered after model name 'SE'.)
- RS-485: Serial Communication modular jack
- When no option is ordered: A1, A2, TRANSMIT OUTPUT1 and TRANSMIT OUTPUT2 terminals are not equipped.

Modular Jack Pin (WIL-102-SE side arrangement)

No. 1		No. 1	COM
No. 6		No. 2	NC
No. 1		No. 3	YB(+)
No. 6		No. 4	YA(-)
RS-485		No. 5	NC
		No. 6	COM

(Fig. 5.2-1)

5.3 Wire the Communication Line

Connect to the modular jack at the bottom of the instrument, using CDD (sold separately) or CPP (sold separately).

- **Wiring Example Using the USB Communication Cable CMC-001-3 (sold separately)**

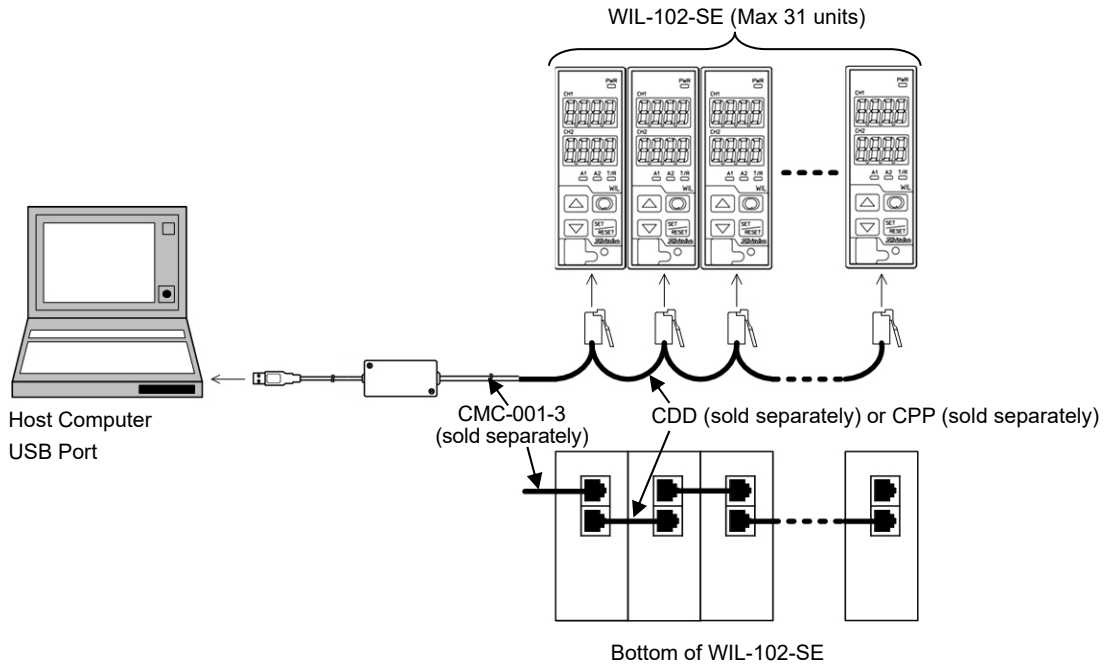

(Fig. 5.3-1)

- **Wiring Example Using a Communication Converter IF-400 (sold separately)**

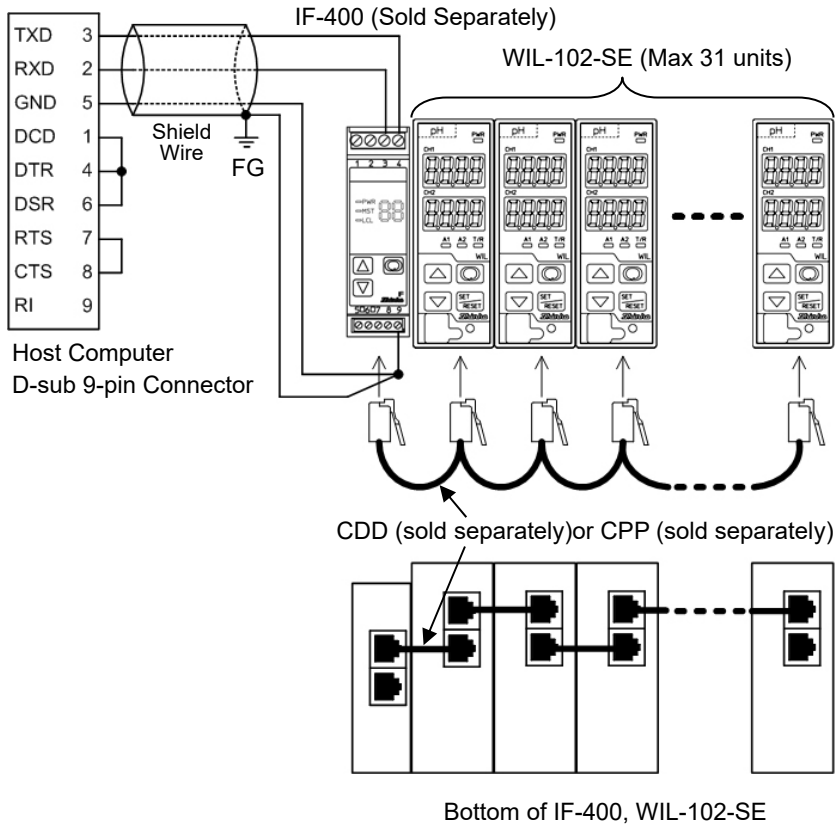

(Fig. 5.3-2)

Shield Wire

Be sure to ground only one end of the shield wire so that current cannot flow to the shield wire. If both ends of the shield wire are grounded, the circuit will be closed, resulting in a ground loop. This may cause noise. Be sure to ground the FG.
Recommended cable: OTSC-VB 2PX0.5SQ (made by Onamba Co., Ltd.) or equivalent
(Use a twisted pair cable.)

Terminator (Terminal Resistor)

The terminator is mounted at the end of the wire when connecting a personal computer with multiple peripheral devices. The terminator prevents signal reflection and disturbance. Do not connect a terminator to the communication line because each WIL-102-SE has built-in pull-up and pull-down resistors.
Communication converter IF-400 (sold separately) has a built-in terminal resistor.

6. Outline of Key Operation and Setting Groups

6.1 Outline of Key Operation

Setting items are divided into groups, and group selection has to be made with keypads. Press the key in Resistivity/Temperature Display Mode. The unit enters Group selection mode. Select a group with the , and press the . The unit enters each setting item. To set each setting item, use the or key, and register the set value with the key.



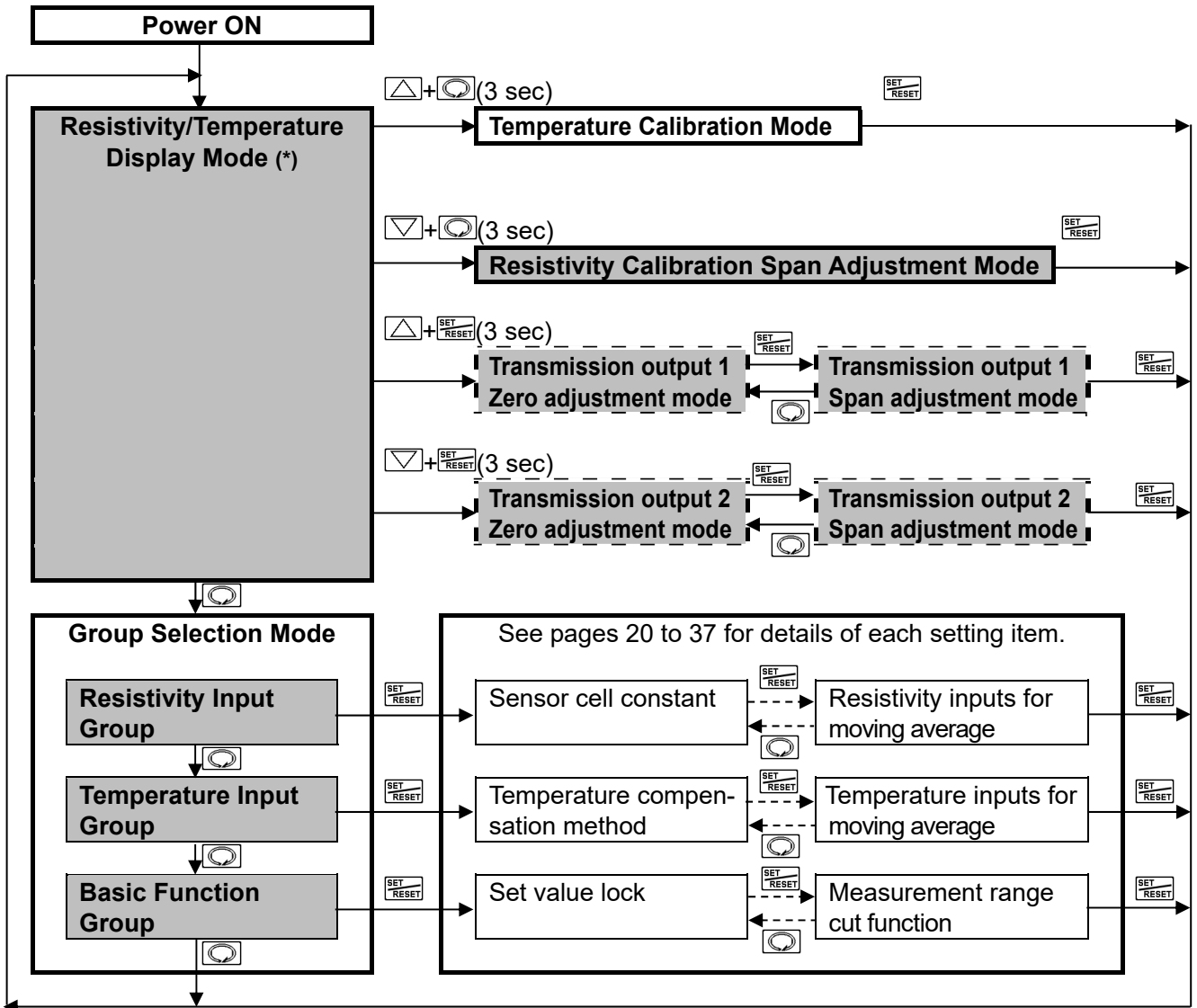





















6.2 Setting Groups



(*) Indicates the item selected in [Display selection (p.33)] in Resistivity/Temperature Display Mode.

Available only when the TA or TA2 option is ordered.

About Key Operation

- + (3 sec): Press and hold the  and  key (in that order) together for 3 seconds.
The unit will proceed to Temperature Calibration mode.
- + (3 sec): Press and hold the  and  key (in that order) together for 3 seconds.
The unit will proceed to Resistivity Calibration Span Adjustment mode.
- + (3 sec): Press and hold the  and  key (in that order) together for 3 seconds.
The unit will proceed to Transmission Output 1 Zero Adjustment Mode.
- + (3 sec): Press and hold the  and  key (in that order) together for 3 seconds.
The unit will proceed to Transmission Output 2 Zero Adjustment Mode.
-  or : If the  or  key is pressed, the unit will proceed to the next setting item, illustrated by an arrow.
-  , : Press the  or  key until the desired setting mode appears.
- If the  key is held down for approx. 3 seconds at any setting item, the unit will revert to Resistivity/Temperature Display Mode.

7. Key Operation Flowchart

Abbreviations:
 Adjust.: Adjustment
 H/L: High/Low limits

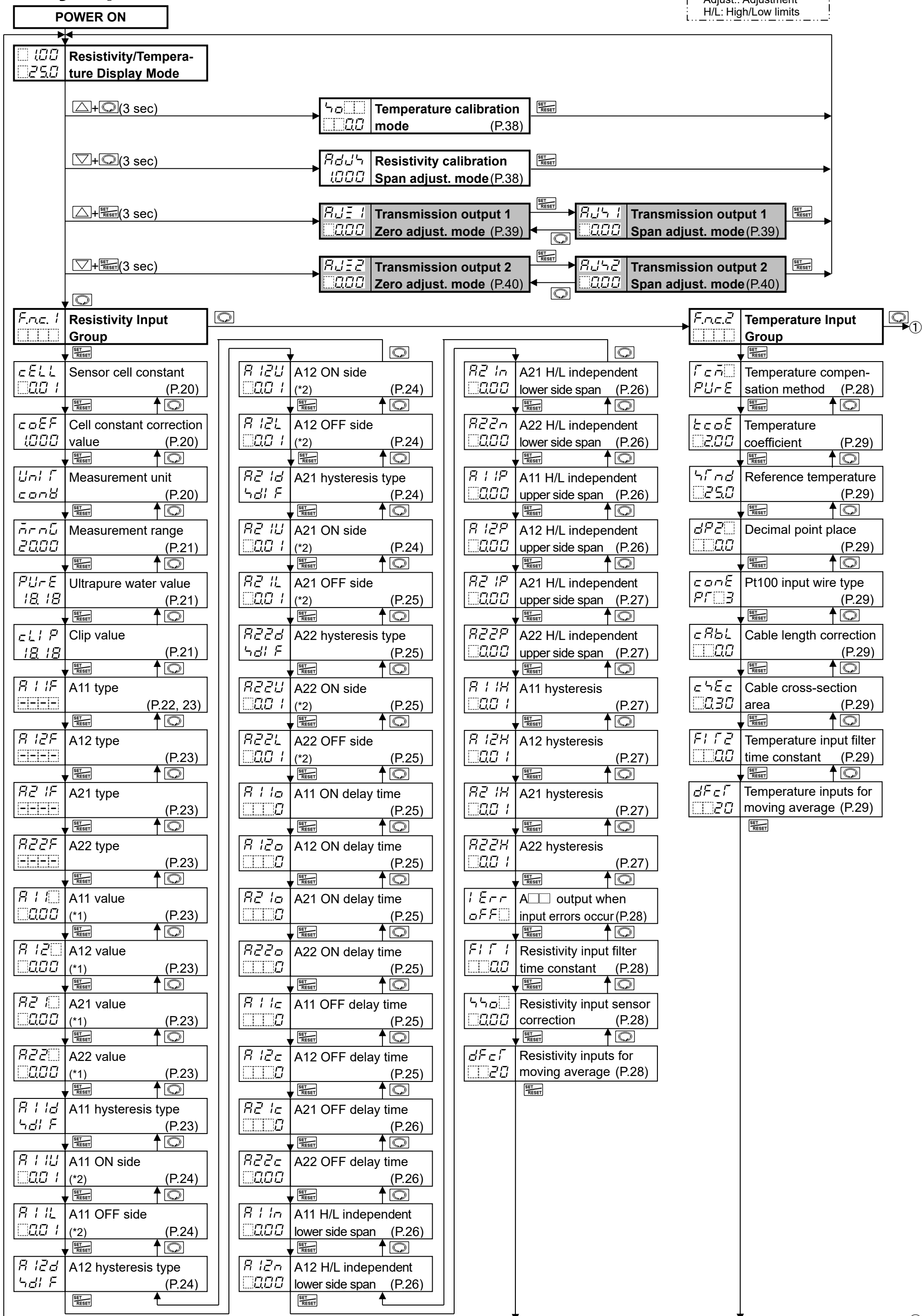

● About Setting Items

cELL	Sensor cell constant
001	(P.20)
Tr01	Transmission output 1
4E	type (P.31)

- **Upper left:** Resistivity Display: Indicates the setting item characters.
 - **Lower left:** Temperature Display (CH2): Indicates the factory default. Setting item in shaded section will be indicated only when the corresponding option is ordered.
 - **Right side:** Indicates the setting item and reference page.
- If the TA option is ordered, A2 related setting items are not available.
 If the TA2 option is ordered, A1 or A2 related setting items are not available.

(*1) Factory default value is different depending on the selection in [A□□ type]. Resistivity input: 0.00, Temperature input: 0.0°C
 (*2) Factory default value is different depending on the selection in [A□□ type]. Resistivity input: 0.01, Temperature input: 1.0°C

● About Key Operation

- $\triangle + \text{SET}$ (3 sec): Press and hold \triangle and SET keys (in that order) together for approx. 3 seconds. The unit enters Temperature Calibration Mode.
- $\nabla + \text{SET}$ (3 sec): Press and hold ∇ and SET keys (in that order) together for approx. 3 seconds. The unit enters Resistivity Calibration Span Adjustment Mode.
- $\triangle + \text{RESET}$ (3 sec): Press and hold \triangle and RESET keys (in that order) together for approx. 3 seconds. The unit enters Transmission Output 1 Zero Adjustment Mode.
- $\nabla + \text{RESET}$ (3 sec): Press and hold ∇ and RESET keys (in that order) together for approx. 3 seconds. The unit enters Transmission Output 2 Zero Adjustment Mode.
- SET or RESET : Press the SET or RESET key. The unit enters the next setting item.
- To revert to Resistivity/Temperature Display Mode, press and hold the SET key for approx. 3 seconds while in any mode.

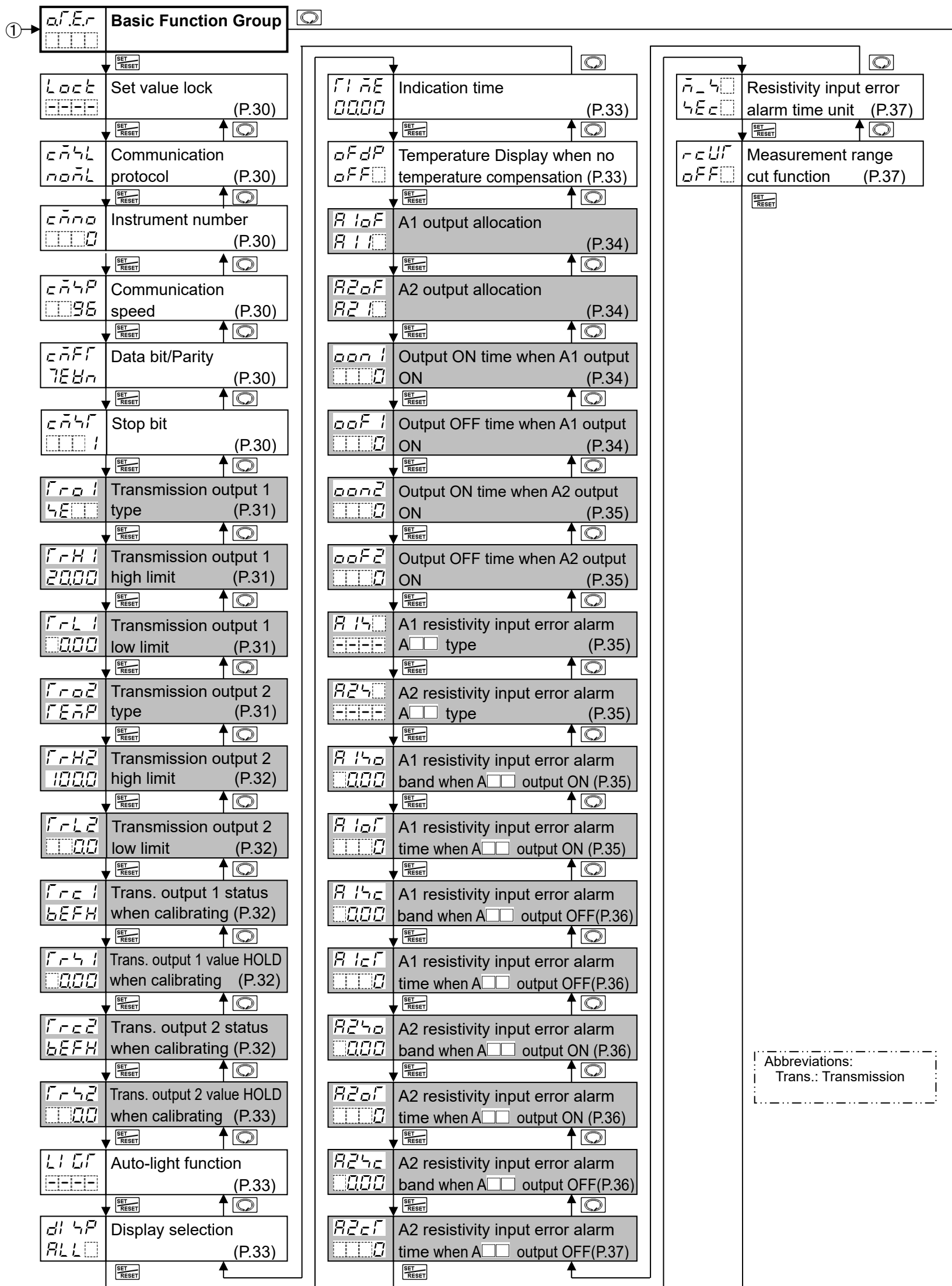

8. Setup

Setup should be done before using this instrument, according to the user's conditions:

Setting the Cell constant correction value, Measurement unit, A11, A12, A21, A22 type, Temperature compensation method, Communication settings, A□□ output when input errors occur, etc.

Setup can be conducted in the Resistivity Input Group, Temperature Input Group and Basic Function Group.

If the user's specification is the same as the factory default of the WIL-102-SE, or if setup has already been completed, it is not necessary to set up the instrument. Proceed to Section "9. Calibration (p.38)".

8.1 Turn the Power Supply ON.

For approx. 4 seconds after the power is switched ON, the input characters are indicated on the Resistivity Display (CH1) and Temperature Display (CH2).

(Table 8.1-1)

Display	Character	Measurement Unit	
Resistivity Display (CH1)	<i>c o n d</i>	Resistivity (MΩ•cm)	
	<i>41 □□</i>	Resistivity (kΩ•m)	
Display	Character	Input Temperature Spec (*)	[Pt100 Input Wire Type] Selection Item (p.29)
Temperature Display (CH2)	<i>P T □ 2</i>	Pt100	<i>P T □ 2</i> : 2-wire type
	<i>P T □ 3</i>		<i>P T □ 3</i> : 3-wire type
	<i>P T 1 0</i>	Pt1000	

(*) This input temperature specification was specified at the time of ordering.



During this time, all outputs are in OFF status, and LED indicators other than the PWR Indicator are turned off.

After that, measurement starts, indicating the item selected in [Display selection (p.33)].

This status is called Resistivity/Temperature Display Mode.

8.2 Resistivity Input Group

To enter the Resistivity Input Group, follow the procedure below.

- ① *F.n.c.1* Press the  key in Resistivity/Temperature Display Mode.
- ② *c E L L* Press the  key.

The unit will enter the Resistivity Input Group, and "Sensor Cell Constant" will appear.

Character	Setting Item, Function, Setting Range	Factory Default
<i>c E L L</i> <i>□□□ 1</i>	Sensor cell constant • Sensor cell constant is displayed. 0.01/cm fixed.	0.01/cm
<i>c o E F</i> <i>1000</i>	Cell constant correction value • Sets sensor cell constant correction value. <i>c o E F</i> and resistivity are displayed alternately. • Setting range: 0.001 to 5.000	1.000
<i>U n i t</i> <i>c o n d</i>	Measurement unit • Selects the resistivity unit. If resistivity unit is changed, the cell constant correction value (Span) will be cleared. Adjust the cell constant correction value (Span) again. • <i>c o n d</i> : Resistivity (MΩ•cm) <i>41 □□</i> : Resistivity (kΩ•m)	Resistivity (MΩ•cm)

Character	Setting Item, Function, Setting Range	Factory Default																					
RANGE 2000	Measurement range • Selects the measurement range of resistivity input. If the measurement range is changed, adjust the cell constant correction value (Span) again. • Selection item differs depending on the measurement unit.	0.00 to 20.00 MΩ•cm																					
	<table border="1"> <thead> <tr> <th>Measurement Unit</th> <th>Selection Item</th> <th>Measurement Range</th> </tr> </thead> <tbody> <tr> <td rowspan="4">Resistivity (MΩ•cm)</td> <td>0.200</td> <td>0.000 to 0.200 MΩ•cm</td> </tr> <tr> <td>2.000</td> <td>0.00 to 2.00 MΩ•cm</td> </tr> <tr> <td>20.000</td> <td>0.00 to 20.00 MΩ•cm</td> </tr> <tr> <td>100.0</td> <td>0.0 to 100.0 MΩ•cm</td> </tr> <tr> <td rowspan="4">Resistivity (kΩ•m)</td> <td>0.200</td> <td>0.00 to 2.00 kΩ•m</td> </tr> <tr> <td>2.000</td> <td>0.0 to 20.0 kΩ•m</td> </tr> <tr> <td>20.000</td> <td>0.0 to 200.0 kΩ•m</td> </tr> <tr> <td>100.0</td> <td>0 to 1000 kΩ•m</td> </tr> </tbody> </table>	Measurement Unit	Selection Item	Measurement Range	Resistivity (MΩ•cm)	0.200	0.000 to 0.200 MΩ•cm	2.000	0.00 to 2.00 MΩ•cm	20.000	0.00 to 20.00 MΩ•cm	100.0	0.0 to 100.0 MΩ•cm	Resistivity (kΩ•m)	0.200	0.00 to 2.00 kΩ•m	2.000	0.0 to 20.0 kΩ•m	20.000	0.0 to 200.0 kΩ•m	100.0	0 to 1000 kΩ•m	
	Measurement Unit	Selection Item	Measurement Range																				
	Resistivity (MΩ•cm)	0.200	0.000 to 0.200 MΩ•cm																				
		2.000	0.00 to 2.00 MΩ•cm																				
		20.000	0.00 to 20.00 MΩ•cm																				
		100.0	0.0 to 100.0 MΩ•cm																				
	Resistivity (kΩ•m)	0.200	0.00 to 2.00 kΩ•m																				
		2.000	0.0 to 20.0 kΩ•m																				
		20.000	0.0 to 200.0 kΩ•m																				
100.0		0 to 1000 kΩ•m																					
PURE 18.18	Ultrapure water value • Selects an ultrapure water value. • Selection item differs depending on the measurement unit.	18.18																					
	<table border="1"> <thead> <tr> <th>Measurement Unit</th> <th>Selection Item</th> <th>Ultrapure Water Value</th> </tr> </thead> <tbody> <tr> <td rowspan="3">Resistivity (MΩ•cm)</td> <td>18.18</td> <td>18.18</td> </tr> <tr> <td>18.23</td> <td>18.23</td> </tr> <tr> <td>18.24</td> <td>18.24</td> </tr> <tr> <td rowspan="3">Resistivity (kΩ•m)</td> <td>181.8</td> <td>181.8</td> </tr> <tr> <td>182.3</td> <td>182.3</td> </tr> <tr> <td>182.4</td> <td>182.4</td> </tr> </tbody> </table>	Measurement Unit	Selection Item	Ultrapure Water Value	Resistivity (MΩ•cm)	18.18	18.18	18.23	18.23	18.24	18.24	Resistivity (kΩ•m)	181.8	181.8	182.3	182.3	182.4	182.4					
	Measurement Unit	Selection Item	Ultrapure Water Value																				
	Resistivity (MΩ•cm)	18.18	18.18																				
		18.23	18.23																				
		18.24	18.24																				
	Resistivity (kΩ•m)	181.8	181.8																				
182.3		182.3																					
182.4		182.4																					
CLIP 18.18	Clip value • Sets the Clip value (Temporary resistivity to be fixed). If resistivity measured value is larger than clip value and smaller than measurement range high limit value, Transmission output 1 and 2 will be fixed at the clip value. For the resistivity indication and Transmission output, see Section 12.1 Attached Functions “Larger than Clip Value, Smaller than Measurement Range High Limit”. (p.67)	18.18 MΩ•cm																					
	• If any item except <i>PURE</i> is selected in [Temperature compensation method] (p.28): If resistivity measured value exceeds measurement range high limit value, the clip value will be voided.																						
	If <i>PURE</i> is selected in [Temperature compensation method] (p.28): If resistivity measured value exceeds the selected ultrapure water value, the clip value will be voided.																						
	• Setting range: If any item except <i>PURE</i> is selected in [Temperature compensation method] (p.28): 0.00 to Measurement range high limit value (*) If <i>PURE</i> is selected in [Temperature compensation method] (p.28): 0.00 to Selected ultrapure water value (*)																						

(*) The measurement unit and decimal point place follow the measurement range.

Character	Setting Item, Function, Setting Range	Factory Default								
A11F [---]	<p>A11 type</p> <ul style="list-style-type: none"> • Selects an A11 type. <p>Note: If A11 type is changed, the A11 value defaults to 0.00 or 0.0.</p> <p>[---] : No action LE_L : Resistivity input low limit action (Fig. 8.2-1) LE_H : Resistivity input high limit action (Fig. 8.2-1) TE_PL : Temperature input low limit action (Fig. 8.2-1) TE_PH : Temperature input high limit action (Fig. 8.2-1) ErOf : Error output [When the error type is "Error" (Table 8.2-1) (p.23), the output is turned ON.] FAiL : Fail output [When the error type is "Fail" (Table 8.2-1) (p.23), the output is turned ON.] LEHL : Resistivity input High/Low limits independent action (Fig. 8.2-2) TEHL : Temperature input High/Low limits independent action (Fig. 8.2-2) <p>• A11 Action (Activated based on the indication value.)</p> <table border="1"> <thead> <tr> <th>Resistivity input low limit action, Temperature input low limit action</th> <th>Resistivity input high limit action, Temperature input high limit action</th> </tr> </thead> <tbody> <tr> <td> <p>If Medium Value is selected in [A11 hysteresis type]:</p> </td> <td> <p>If Medium Value is selected in [A11 hysteresis type]:</p> </td> </tr> <tr> <td> <p>If Reference Value is selected in [A11 hysteresis type]:</p> </td> <td> <p>If Reference Value is selected in [A11 hysteresis type]:</p> </td> </tr> </tbody> </table> <p>(Fig. 8.2-1)</p> <p>* Setting Example: If [A11 ON side (A11H)] is set to 0.00 or 0.0, A11 output can be turned ON at the value set in [A11 value (A11V)]. If [A11 OFF side (A11L)] is set to 0.00 or 0.0, A11 output can be turned OFF at the value set in [A11 value (A11V)].</p> <table border="1"> <thead> <tr> <th>Resistivity input High/Low limits independent action Temperature input High/Low limits independent action</th> </tr> </thead> <tbody> <tr> <td> </td> </tr> </tbody> </table> <p>(Fig. 8.2-2)</p> </p>	Resistivity input low limit action, Temperature input low limit action	Resistivity input high limit action, Temperature input high limit action	<p>If Medium Value is selected in [A11 hysteresis type]:</p>	<p>If Medium Value is selected in [A11 hysteresis type]:</p>	<p>If Reference Value is selected in [A11 hysteresis type]:</p>	<p>If Reference Value is selected in [A11 hysteresis type]:</p>	Resistivity input High/Low limits independent action Temperature input High/Low limits independent action		No action
Resistivity input low limit action, Temperature input low limit action	Resistivity input high limit action, Temperature input high limit action									
<p>If Medium Value is selected in [A11 hysteresis type]:</p>	<p>If Medium Value is selected in [A11 hysteresis type]:</p>									
<p>If Reference Value is selected in [A11 hysteresis type]:</p>	<p>If Reference Value is selected in [A11 hysteresis type]:</p>									
Resistivity input High/Low limits independent action Temperature input High/Low limits independent action										

Character	Setting Item, Function, Setting Range	Factory Default															
	<p>• Error output, Fail output (Table 8.2-1)</p> <table border="1"> <thead> <tr> <th>Error Type</th> <th>Error</th> <th>Description</th> </tr> </thead> <tbody> <tr> <td>Fail</td> <td>Temperature sensor burnout</td> <td>Temperature sensor lead wire is burnt out.</td> </tr> <tr> <td>Fail</td> <td>Temperature sensor short-circuited</td> <td>Temperature sensor lead wire is short-circuited.</td> </tr> <tr> <td>Error</td> <td>Outside temperature compensation range</td> <td>Measured temperature has exceeded 110.0°C.</td> </tr> <tr> <td>Error</td> <td>Outside temperature compensation range</td> <td>Measured temperature is less than 0.0°C.</td> </tr> </tbody> </table>	Error Type	Error	Description	Fail	Temperature sensor burnout	Temperature sensor lead wire is burnt out.	Fail	Temperature sensor short-circuited	Temperature sensor lead wire is short-circuited.	Error	Outside temperature compensation range	Measured temperature has exceeded 110.0°C.	Error	Outside temperature compensation range	Measured temperature is less than 0.0°C.	
Error Type	Error	Description															
Fail	Temperature sensor burnout	Temperature sensor lead wire is burnt out.															
Fail	Temperature sensor short-circuited	Temperature sensor lead wire is short-circuited.															
Error	Outside temperature compensation range	Measured temperature has exceeded 110.0°C.															
Error	Outside temperature compensation range	Measured temperature is less than 0.0°C.															
A12F E-E-E	<p>A12 type</p> <ul style="list-style-type: none"> • Selects an A12 type. <p>Note: If an A12 type is changed, the A12 value defaults to 0.00 or 0.0.</p> <ul style="list-style-type: none"> • For the selection item and action, refer to [A11 type]. (pp.22, 23) 	No action															
A21F E-E-E	<p>A21 type</p> <ul style="list-style-type: none"> • Selects an A21 type. <p>Note: If an A21 type is changed, the A21 value defaults to 0.00 or 0.0.</p> <ul style="list-style-type: none"> • For the selection item and action, refer to [A11 type]. (pp.22, 23) 	No action															
A22F E-E-E	<p>A22 type</p> <ul style="list-style-type: none"> • Selects an A22 type. <p>Note: If an A22 type is changed, the A22 value defaults to 0.00 or 0.0.</p> <ul style="list-style-type: none"> • For the selection item and action, refer to [A11 type]. (pp.22, 23) 	No action															
A10 0.000	<p>A11 value</p> <ul style="list-style-type: none"> • Sets an A11 value. • Not available if E-E-E (No action), Error (Error output) or FAIL (Fail output) is selected in [A11 type]. • A11 is activated based on the indication value. • Setting range: Resistivity input: Measurement range low limit to Measurement range high limit (*1) Temperature input: 0.0 to 100.0°C (*2) 	Resistivity input: 0.00 MΩ·cm Temperature input: 0.0°C															
A12 0.000	<p>A12 value</p> <ul style="list-style-type: none"> • Sets an A12 value. • For the indication condition, activation condition and setting range, refer to [A11 value]. (p.23) 	Resistivity input: 0.00 MΩ·cm Temperature input: 0.0°C															
A21 0.000	<p>A21 value</p> <ul style="list-style-type: none"> • Sets an A21 value. • For the indication condition, activation condition and setting range, refer to [A11 value]. (p.23) 	Resistivity input: 0.00 MΩ·cm Temperature input: 0.0°C															
A22 0.000	<p>A22 value</p> <ul style="list-style-type: none"> • Sets an A22 value. • For the indication condition, activation condition and setting range, refer to [A11 value]. (p.23) 	Resistivity input: 0.00 MΩ·cm Temperature input: 0.0°C															
A11d 4d1F	<p>A11 hysteresis type</p> <ul style="list-style-type: none"> • Selects A11 hysteresis type (Medium or Reference Value). • Available when 4E-L (Resistivity input low limit action), 4E-H (Resistivity input high limit action), 7APL (Temperature input low limit action) or 7APH (Temperature input high limit action) is selected in [A11 type]. • 4d1F: Medium Value Sets the same value for both ON and OFF sides in relation to A11 value. Only ON side needs to be set. • 4d1F: Reference Value Sets individual values for ON and OFF sides in relation to A11 value. Both ON and OFF sides need to be set individually. 	Reference Value															

(*1) The measurement unit and decimal point place follow the measurement range.

(*2) The decimal point place does not follow the selection. It is fixed.

Character	Setting Item, Function, Setting Range	Factory Default																							
A11U 0001	A11 ON side <ul style="list-style-type: none"> Sets the span of A11 ON side. If <i>c d l F</i> (Medium Value) is selected in [A11 hysteresis type], the span of ON/OFF side will be the same value. Available when <i>h E - L</i> (Resistivity input low limit action), <i>h E - H</i> (Resistivity input high limit action), <i>T n P L</i> (Temperature input low limit action) or <i>T n P H</i> (Temperature input high limit action) is selected in [A11 type]. Setting range differs depending on the A11 type and measurement range. <p>(Table 8.2-2)</p> <table border="1"> <thead> <tr> <th>A11 Type</th> <th>Measurement Range</th> <th>Setting Range</th> </tr> </thead> <tbody> <tr> <td rowspan="8">Resistivity input low limit action Resistivity input high limit action</td> <td>0.000 to 0.200 MΩ•cm</td> <td>0.000 to 0.020 MΩ•cm</td> </tr> <tr> <td>0.00 to 2.00 MΩ•cm</td> <td>0.00 to 0.20 MΩ•cm</td> </tr> <tr> <td>0.00 to 20.00 MΩ•cm</td> <td>0.00 to 2.00 MΩ•cm</td> </tr> <tr> <td>0.0 to 100.0 MΩ•cm</td> <td>0.0 to 10.0 MΩ•cm</td> </tr> <tr> <td>0.00 to 2.00 kΩ•m</td> <td>0.00 to 0.20 kΩ•cm</td> </tr> <tr> <td>0.0 to 20.0 kΩ•m</td> <td>0.0 to 2.0 kΩ•cm</td> </tr> <tr> <td>0.0 to 200.0 kΩ•m</td> <td>0.0 to 20.0 kΩ•cm</td> </tr> <tr> <td>0 to 1000 kΩ•m</td> <td>0 to 100 kΩ•cm</td> </tr> <tr> <td>Temperature input low limit action Temperature input high limit action</td> <td>0.0 to 100.0°C</td> <td>0.0 to 10.0°C</td> </tr> </tbody> </table>	A11 Type	Measurement Range	Setting Range	Resistivity input low limit action Resistivity input high limit action	0.000 to 0.200 MΩ•cm	0.000 to 0.020 MΩ•cm	0.00 to 2.00 MΩ•cm	0.00 to 0.20 MΩ•cm	0.00 to 20.00 MΩ•cm	0.00 to 2.00 MΩ•cm	0.0 to 100.0 MΩ•cm	0.0 to 10.0 MΩ•cm	0.00 to 2.00 kΩ•m	0.00 to 0.20 kΩ•cm	0.0 to 20.0 kΩ•m	0.0 to 2.0 kΩ•cm	0.0 to 200.0 kΩ•m	0.0 to 20.0 kΩ•cm	0 to 1000 kΩ•m	0 to 100 kΩ•cm	Temperature input low limit action Temperature input high limit action	0.0 to 100.0°C	0.0 to 10.0°C	Resistivity input: 0.01 MΩ•cm Temperature input: 1.0°C
A11 Type	Measurement Range	Setting Range																							
Resistivity input low limit action Resistivity input high limit action	0.000 to 0.200 MΩ•cm	0.000 to 0.020 MΩ•cm																							
	0.00 to 2.00 MΩ•cm	0.00 to 0.20 MΩ•cm																							
	0.00 to 20.00 MΩ•cm	0.00 to 2.00 MΩ•cm																							
	0.0 to 100.0 MΩ•cm	0.0 to 10.0 MΩ•cm																							
	0.00 to 2.00 kΩ•m	0.00 to 0.20 kΩ•cm																							
	0.0 to 20.0 kΩ•m	0.0 to 2.0 kΩ•cm																							
	0.0 to 200.0 kΩ•m	0.0 to 20.0 kΩ•cm																							
	0 to 1000 kΩ•m	0 to 100 kΩ•cm																							
Temperature input low limit action Temperature input high limit action	0.0 to 100.0°C	0.0 to 10.0°C																							
A11L 0001	A11 OFF side <ul style="list-style-type: none"> Sets the span of A11 OFF side. Available when <i>h d l F</i> (Reference Value) is selected in [A11 hysteresis type]. Available when <i>h E - L</i> (Resistivity input low limit action), <i>h E - H</i> (Resistivity input high limit action), <i>T n P L</i> (Temperature input low limit action) or <i>T n P H</i> (Temperature input high limit action) is selected in [A11 type]. Setting range differs depending on the A11 type and measurement range. <p>See (Table 8.2-2). (p.24)</p>	Resistivity input: 0.01 MΩ•cm Temperature input: 1.0°C																							
A12d <i>h d l F</i>	A12 hysteresis type <ul style="list-style-type: none"> Selects A12 hysteresis type (Medium or Reference Value). For the indication condition and selection item, refer to [A11 hysteresis type]. (p.23) 	Reference Value																							
A12U 0001	A12 ON side <ul style="list-style-type: none"> Sets the span of A12 ON side. If <i>c d l F</i> (Medium Value) is selected in [A12 hysteresis type], the span of ON/OFF side will be the same value. For the indication condition and setting range, refer to [A11 ON side]. (p.24) 	Resistivity input: 0.01 MΩ•cm Temperature input: 1.0°C																							
A12L 0001	A12 OFF side <ul style="list-style-type: none"> Sets the span of A12 OFF side. For the indication condition and setting range, refer to [A11 OFF side]. (p.24) 	Resistivity input: 0.01 MΩ•cm Temperature input: 1.0°C																							
A21d <i>h d l F</i>	A21 hysteresis type <ul style="list-style-type: none"> Selects A21 hysteresis type (Medium or Reference Value). For the indication condition and selection item, refer to [A11 hysteresis type]. (p.23) 	Reference Value																							
A21U 0001	A21 ON side <ul style="list-style-type: none"> Sets the span of A21 ON side. If <i>c d l F</i> (Medium Value) is selected in [A21 hysteresis type], the span of ON/OFF side will be the same value. For the indication condition and setting range, refer to [A11 ON side]. (p.24) 	Resistivity input: 0.01 MΩ•cm Temperature input: 1.0°C																							

Character	Setting Item, Function, Setting Range	Factory Default
A21 IL □□□□	A21 OFF side • Sets the span of A21 OFF side. • For the indication condition and setting range, refer to [A11 OFF side]. (p.24)	Resistivity input: 0.01 MΩ·cm Temperature input: 1.0°C
A22 d 4 d1 F	A22 hysteresis type • Selects A22 hysteresis type (Medium or Reference Value). • For the indication condition and selection item, refer to [A11 hysteresis type]. (p.23)	Reference Value
A22 U □□□□	A22 ON side • Sets the span of A22 ON side. If <i>c d1 F</i> (Medium Value) is selected in [A22 hysteresis type], the span of ON/OFF side will be the same value. • For the indication condition and setting range, refer to [A11 ON side]. (p.24)	Resistivity input: 0.01 MΩ·cm Temperature input: 1.0°C
A22 L □□□□	A22 OFF side • Sets the span of A22 OFF side. • For the indication condition and setting range, refer to [A11 OFF side]. (p.24)	Resistivity input: 0.01 MΩ·cm Temperature input: 1.0°C
A11 d □□□□	A11 ON delay time • Sets A11 ON delay time. The A11 does not turn ON until the time set in [A11 ON delay time] elapses. • Not available if □□□□ (No action), <i>Er r d r</i> (Error output) or <i>F r i L</i> (Fail output) is selected in [A11 type]. • Setting range: 0 to 9999 seconds	0 seconds
A12 d □□□□	A12 ON delay time • Sets A12 ON delay time. The A12 does not turn ON until the time set in [A12 ON delay time] elapses. • For the indication condition and setting range, refer to [A11 ON delay time]. (p.25)	0 seconds
A21 d □□□□	A21 ON delay time • Sets A21 ON delay time. The A21 does not turn ON until the time set in [A21 ON delay time] elapses. • For the indication condition and setting range, refer to [A11 ON delay time]. (p.25)	0 seconds
A22 d □□□□	A22 ON delay time • Sets A22 ON delay time. The A22 does not turn ON until the time set in [A22 ON delay time] elapses. • For the indication condition and setting range, refer to [A11 ON delay time]. (p.25)	0 seconds
A11 c □□□□	A11 OFF delay time • Sets A11 OFF delay time. The A11 does not turn OFF until the time set in [A11 OFF delay time] elapses. • Not available if □□□□ (No action), <i>Er r d r</i> (Error output) or <i>F r i L</i> (Fail output) is selected in [A11 type]. • Setting range: 0 to 9999 seconds	0 seconds
A12 c □□□□	A12 OFF delay time • Sets A12 OFF delay time. The A12 does not turn OFF until the time set in [A12 OFF delay time] elapses. • For the indication condition and setting range, refer to [A11 OFF delay time]. (p.25)	0 seconds

Character	Setting Item, Function, Setting Range	Factory Default
A21c □□□□	A21 OFF delay time • Sets A21 OFF delay time. The A21 does not turn OFF until the time set in [A21 OFF delay time] elapses. • For the indication condition and setting range, refer to [A11 OFF delay time]. (p.25)	0 seconds
A22c □□□□	A22 OFF delay time • Sets A22 OFF delay time. The A22 does not turn OFF until the time set in [A22 OFF delay time] elapses. • For the indication condition and setting range, refer to [A11 OFF delay time]. (p.25)	0 seconds
A11n □□□□	A11 High/Low limits independent lower side span • Sets the lower side span of A11 High/Low limits independent action. Disabled when set to 0.00 or 0.0. • Available when $\overline{L}EHL$ (Resistivity input High/Low limits independent action) or $\overline{T}nHL$ (Temperature input High/Low limits independent action) is selected in [A11 type]. • Setting range: Resistivity input: Measurement range low limit to Measurement range high limit (*1) Temperature input: 0.0 to 100.0°C (*2)	Resistivity input: 0.00 MΩ·cm Temperature input: 0.0°C
A12n □□□□	A12 High/Low limits independent lower side span • Sets the lower side span of A12 High/Low limits independent action. • For the action, indication condition and setting range, refer to [A11 High/Low limits independent lower side span]. (p.26)	Resistivity input: 0.00 MΩ·cm Temperature input: 0.0°C
A21n □□□□	A21 High/Low limits independent lower side span • Sets the lower side span of A21 High/Low limits independent action. • For the action, indication condition and setting range, refer to [A11 High/Low limits independent lower side span]. (p.26)	Resistivity input: 0.00 MΩ·cm Temperature input: 0.0°C
A22n □□□□	A22 High/Low limits independent lower side span • Sets the lower side span of A22 High/Low limits independent action. • For the action, indication condition and setting range, refer to [A11 High/Low limits independent lower side span]. (p.26)	Resistivity input: 0.00 MΩ·cm Temperature input: 0.0°C
A11P □□□□	A11 High/Low limits independent upper side span • Sets the upper side span of A11 High/Low limits independent action. Disabled when set to 0.00 or 0.0. • Available when $\overline{L}EHL$ (Resistivity input High/Low limits independent action) or $\overline{T}nHL$ (Temperature input High/Low limits independent action) is selected in [A11 type]. • Setting range: Resistivity input: Measurement range low limit to Measurement range high limit (*1) Temperature input: 0.0 to 100.0°C (*2)	Resistivity input: 0.00 MΩ·cm Temperature input: 0.0°C
A12P □□□□	A12 High/Low limits independent upper side span • Sets the upper side span of A12 High/Low limits independent action. • For the action, indication condition and setting range, refer to [A11 High/Low limits independent upper side span]. (p.26)	Resistivity input: 0.00 MΩ·cm Temperature input: 0.0°C

(*1) The measurement unit and decimal point place follow the measurement range.

(*2) The decimal point place does not follow the selection. It is fixed.



Character	Setting Item, Function, Setting Range	Factory Default																							
A2 1P 000	A21 High/Low limits independent upper side span <ul style="list-style-type: none"> Sets the upper side span of A21 High/Low limits independent action. For the action, indication condition and setting range, refer to [A11 High/Low limits independent upper side span]. (p.26) 	Resistivity input: 0.00 MΩ•cm Temperature input: 0.0°C																							
A22P 000	A22 High/Low limits independent upper side span <ul style="list-style-type: none"> Sets the upper side span of A22 High/Low limits independent action. For the action, indication condition and setting range, refer to [A11 High/Low limits independent upper side span]. (p.26) 	Resistivity input: 0.00 MΩ•cm Temperature input: 0.0°C																							
A1 1H 001	A11 hysteresis <ul style="list-style-type: none"> Sets hysteresis of A11 High/Low limits independent action.(Fig. 8.2-2)(p.22) Available when H EHL (Resistivity input High/Low limits independent action) or T HL (Temperature input High/Low limits independent action) is selected in [A11 type]. <p>(Table 8.2-3)</p> <table border="1"> <thead> <tr> <th>A11 Action</th> <th>Measurement Range</th> <th>Setting Range</th> </tr> </thead> <tbody> <tr> <td rowspan="8">Resistivity input</td> <td>0.000 to 0.200 MΩ•cm</td> <td>0.001 to 0.020 MΩ•cm</td> </tr> <tr> <td>0.00 to 2.00 MΩ•cm</td> <td>0.01 to 0.20 MΩ•cm</td> </tr> <tr> <td>0.00 to 20.00 MΩ•cm</td> <td>0.01 to 2.00 MΩ•cm</td> </tr> <tr> <td>0.0 to 100.0 MΩ•cm</td> <td>0.1 to 10.0 MΩ•cm</td> </tr> <tr> <td>0.00 to 2.00 kΩ•m</td> <td>0.01 to 0.20 kΩ•m</td> </tr> <tr> <td>0.0 to 20.0 kΩ•m</td> <td>0.1 to 2.0 kΩ•m</td> </tr> <tr> <td>0.0 to 200.0 kΩ•m</td> <td>0.1 to 20.0 kΩ•m</td> </tr> <tr> <td>0 to 1000 kΩ•m</td> <td>1 to 100 kΩ•m</td> </tr> <tr> <td>Temperature input</td> <td>0.0 to 100.0°C</td> <td>0.1 to 10.0°C</td> </tr> </tbody> </table>	A11 Action	Measurement Range	Setting Range	Resistivity input	0.000 to 0.200 MΩ•cm	0.001 to 0.020 MΩ•cm	0.00 to 2.00 MΩ•cm	0.01 to 0.20 MΩ•cm	0.00 to 20.00 MΩ•cm	0.01 to 2.00 MΩ•cm	0.0 to 100.0 MΩ•cm	0.1 to 10.0 MΩ•cm	0.00 to 2.00 kΩ•m	0.01 to 0.20 kΩ•m	0.0 to 20.0 kΩ•m	0.1 to 2.0 kΩ•m	0.0 to 200.0 kΩ•m	0.1 to 20.0 kΩ•m	0 to 1000 kΩ•m	1 to 100 kΩ•m	Temperature input	0.0 to 100.0°C	0.1 to 10.0°C	Resistivity input: 0.01 MΩ•cm Temperature input: 1.0°C
A11 Action	Measurement Range	Setting Range																							
Resistivity input	0.000 to 0.200 MΩ•cm	0.001 to 0.020 MΩ•cm																							
	0.00 to 2.00 MΩ•cm	0.01 to 0.20 MΩ•cm																							
	0.00 to 20.00 MΩ•cm	0.01 to 2.00 MΩ•cm																							
	0.0 to 100.0 MΩ•cm	0.1 to 10.0 MΩ•cm																							
	0.00 to 2.00 kΩ•m	0.01 to 0.20 kΩ•m																							
	0.0 to 20.0 kΩ•m	0.1 to 2.0 kΩ•m																							
	0.0 to 200.0 kΩ•m	0.1 to 20.0 kΩ•m																							
	0 to 1000 kΩ•m	1 to 100 kΩ•m																							
Temperature input	0.0 to 100.0°C	0.1 to 10.0°C																							
A12H 001	A12 hysteresis <ul style="list-style-type: none"> Sets hysteresis of A12 High/Low limits independent action. (Fig. 8.2-2)(p.22) Available when H EHL (Resistivity input High/Low limits independent action) or T HL (Temperature input High/Low limits independent action) is selected in [A12 type]. Setting range: Refer to [A11 hysteresis].(p.27) 	Resistivity input: 0.01 MΩ•cm Temperature input: 1.0°C																							
A2 1H 001	A21 hysteresis <ul style="list-style-type: none"> Sets hysteresis of A21 High/Low limits independent action. (Fig. 8.2-2)(p.22) Available when H EHL (Resistivity input High/Low limits independent action) or T HL (Temperature input High/Low limits independent action) is selected in [A21 type]. Setting range: Refer to [A11 hysteresis].(p.27) 	Resistivity input: 0.01 MΩ•cm Temperature input: 1.0°C																							
A22H 001	A22 hysteresis <ul style="list-style-type: none"> Sets hysteresis of A22 High/Low limits independent action. (Fig. 8.2-2)(p.22) Available when H EHL (Resistivity input High/Low limits independent action) or T HL (Temperature input High/Low limits independent action) is selected in [A22 type]. Setting range: Refer to [A11 hysteresis].(p.27) 	Resistivity input: 0.01 MΩ•cm Temperature input: 1.0°C																							

Character	Setting Item, Function, Setting Range	Factory Default
IErr OFF	A□□ output when input errors occur <ul style="list-style-type: none"> If input errors occur, such as resistivity sensor disconnection or short circuit, A□□ output Enabled/Disabled can be selected. If “Enabled” is selected, A□□ output and A□□ output status will be maintained when input errors occur. If “Disabled” is selected, A□□ output and A□□ output status will be turned OFF when input errors occur. Available when LE_L (Resistivity input low limit action), LE_H (Resistivity input high limit action), $TEMP_L$ (Temperature input low limit action) or $TEMP_H$ (Temperature input high limit action) is selected in [A□□ type]. ON : Enabled OFF : Disabled 	Disabled
FIL □□□	Resistivity input filter time constant <ul style="list-style-type: none"> Sets Resistivity input filter time constant. If the value is set too large, it affects A□□ output due to the delay of response. Setting range: 0.0 to 10.0 seconds 	0.0 seconds
440 □□□	Resistivity input sensor correction <ul style="list-style-type: none"> Sets resistivity input sensor correction value. This corrects the input value from the resistivity sensor. When a sensor cannot be set at the exact location where measurement is desired, the sensor-measured resistivity may deviate from the resistivity in the measured location. In this case, desired resistivity can be obtained by adding a sensor correction value. However, it is only effective within the measurement range regardless of the sensor correction value. Resistivity after sensor correction= Current resistivity + (Sensor correction value) Setting range: ±10% of measurement span (*) 	0.00 MΩ·cm
dFct □□20	Resistivity inputs for moving average <ul style="list-style-type: none"> Set the number of resistivity inputs used to obtain moving average. An average resistivity input value is calculated using the selected number of resistivity inputs. The resistivity input value is replaced every input sampling period. However, the resistivity input moving average function is disabled in cell correction value (Span) adjustment mode or in temperature calibration mode. Setting range: 1 to 120 	20

(*) The measurement unit and decimal point place follow the measurement range.

8.3 Temperature Input Group

To enter the Temperature Input Group, follow the procedure below.

- ① $F.n.c.2$ Press the  key twice in Resistivity/Temperature Display Mode.
- ② TCn Press the  key.

The unit will enter the Temperature Input Group, and “Temperature compensation method” will appear.

Character	Setting Item, Function, Setting Range	Factory Default
TCn PURE	Temperature compensation method <ul style="list-style-type: none"> Selects Temperature compensation calculation method. $PURE$: Temperature compensation is conducted using temperature characteristics of deionized water. $PURF$: Temperature compensation is conducted using temperature characteristics of deionized water and impure substances. $TCOE$: Temperature compensation is conducted using temperature coefficient (%/°C) and randomly selected reference temperature. OFF : No temperature compensation 	Temperature characteristics of deionized water

Character	Setting Item, Function, Setting Range	Factory Default
tc0E □200	Temperature coefficient <ul style="list-style-type: none"> • Sets Temperature coefficient. If Temperature coefficient is set to 2.00 %/°C, this value can be used for most aqueous solutions. If Temperature coefficient of an aqueous solution is known, set the value. If Temperature coefficient is set to 0.00 %/°C, resistivity without temperature compensation will be indicated. • Not available if <i>PUR E</i> or <i>OFF</i> (No temperature compensation) is selected in [Temperature compensation method]. • Setting range: -5.00 to 5.00 %/°C 	2.00 %/°C
4Tnd □25.0	Reference temperature <ul style="list-style-type: none"> • Sets the reference temperature for temperature compensation. • Setting range: 5.0 to 95.0°C (*) 	25.0°C
dp2□ □□00	Decimal point place <ul style="list-style-type: none"> • Selects decimal point place. • □□□□ : No decimal point □□□□ : 1 digit after decimal point 	1 digit after decimal point
conE PT□3	Pt100 input wire type <ul style="list-style-type: none"> • Selects the input wire type of Pt100. • Not available for Temperature element Pt1000. Available when <i>PH</i> (Measured value) is selected in [Temperature Display when no temperature compensation]. • <i>PT</i>□2 : 2-wire type <i>PT</i>□3 : 3-wire type 	3-wire type
cAbL □□00	Cable length correction <ul style="list-style-type: none"> • Sets the cable length correction value. • Not available for Temperature element Pt1000. Available only when <i>PT</i>□2 (2-wire type) is selected in [Pt100 input wire type]. • Setting range: 0.0 to 100.0 m 	0.0 m
c4Ec □0.30	Cable cross-section area <ul style="list-style-type: none"> • Sets the cable cross-section area. • Not available for Temperature element Pt1000. Available only when <i>PT</i>□2 (2-wire type) is selected in [Pt100 input wire type]. • Setting range: 0.10 to 2.00 mm² 	0.30 mm ²
Flr2 □□00	Temperature input filter time constant <ul style="list-style-type: none"> • Sets Temperature input filter time constant. If the value is set too large, it affects A□□ output due to the delay of response. • Setting range: 0.0 to 10.0 seconds 	0.0 seconds
dFct □□20	Temperature inputs for moving average <ul style="list-style-type: none"> • Set the number of temperature inputs used to obtain moving average. An average temperature input value is calculated using the selected number of temperature inputs. The temperature input value is replaced every input sampling period. However, the temperature input moving average function is disabled in temperature calibration mode. • Setting range: 1 to 120 	20

(*) The placement of the decimal point follows the selection.











8.4 Basic Function Group

To enter the Basic Function Group, follow the procedure below.

① *afEr* Press the  key 3 times in Resistivity/Temperature Display Mode.

② *Loc t* Press the  key.

The unit will enter the Basic Function Group, and the “Set value lock” will appear.

Character	Setting Item, Function, Setting Range	Factory Default
<i>Lock</i> 	Set value lock <ul style="list-style-type: none"> Locks the set values to prevent setting errors.  (Unlock): All set values can be changed. <i>Loc 1</i> (Lock 1): None of the set values can be changed. <i>Loc 2</i> (Lock 2): Only A11, A12, A21, A22 values can be changed. <i>Loc 3</i> (Lock 3): All set values – except Measurement unit, Measurement range, Resistivity calibration value, Temperature calibration value, Transmission output 1 Zero and Span adjustment values, Transmission output 2 Zero and Span adjustment values – can be temporarily changed. <p>However, they revert to their previous value after the power is turned off because they are not saved in the non-volatile IC memory.</p> <p>Do not change setting items (A11, A12, A21, A22 types).</p> <p>If they are changed, they will affect other setting items.</p> <p>Be sure to select Lock 3 when changing the set value frequently via communication function. (If the value set by the communication function is the same as the value before the setting, the value will not be written in the non-volatile IC memory.)</p>	Unlock
<i>cn4L</i> <i>nonL</i>	Communication protocol <ul style="list-style-type: none"> Selects communication protocol. <i>nonL</i> : Shinko protocol <i>nodA</i> : MODBUS ASCII mode <i>nodR</i> : MODBUS RTU mode 	Shinko protocol
<i>cnno</i> 	Instrument number <ul style="list-style-type: none"> Sets the instrument number. The instrument numbers should be set one by one when multiple instruments are connected. Setting range: 0 to 95 	0
<i>cn4P</i> 	Communication speed <ul style="list-style-type: none"> Selects a communication speed equal to that of the host computer.  : 9600 bps  : 19200 bps  : 38400 bps 	9600 bps
<i>cn4P</i> <i>7EBn</i>	Data bit/Parity <ul style="list-style-type: none"> Selects data bit and parity. <i>8non</i> : 8 bits/No parity <i>7non</i> : 7 bits/No parity <i>8EBn</i> : 8 bits/Even <i>7EBn</i> : 7 bits/Even <i>8odd</i> : 8 bits/Odd <i>7odd</i> : 7 bits/Odd 	7 bits/Even
<i>cn4P</i> 	Stop bit <ul style="list-style-type: none"> Selects the stop bit.  : 1 bit  : 2 bits 	1 bit

Character	Setting Item, Function, Setting Range	Factory Default
Trd1 4E□□	Transmission output 1 type <ul style="list-style-type: none"> • Selects Transmission output 1 type. • If OFF□ (No temperature compensation) is selected in [Temperature compensation method (p.28)], and if TEMP (Temperature transmission) is selected, Transmission output 1 value will differ depending on the selection in [Temperature Display when no temperature compensation (p.33)] as follows. <ul style="list-style-type: none"> If OFF□ (Unlit) or Ref□ (Reference temperature) is selected, the value set in [Reference temperature (p.29)] will be output. If PV□ (Measured value) is selected, the measured value will be output. • Available only when Transmission output 1 (TA option) or Transmission output 2 (TA2 option) is ordered. • 4E□□: Resistivity transmission TEMP: Temperature transmission 	Resistivity transmission
TrH1 2000	Transmission output 1 high limit <ul style="list-style-type: none"> • Sets Transmission output 1 high limit value. (This value corresponds to 20 mA DC output.) If Transmission output 1 high limit and low limit are set to the same value, Transmission output 1 will be fixed at 4 mA DC. • Available only when Transmission output 1 (TA option) or Transmission output 2 (TA2 option) is ordered. • Setting range: If 4E□□ (Resistivity Transmission) is selected in [Transmission output 1 type]: Transmission output 1 low limit to Resistivity range high limit (*1) If TEMP (Temperature Transmission) is selected in [Transmission output 1 type]: Transmission output 1 low limit to 100.0°C (*2) 	Resistivity transmission: 20.00 MΩ•cm Temperature transmission: 100.0°C
TrL1 □000	Transmission output 1 low limit <ul style="list-style-type: none"> • Sets the Transmission output 1 low limit value. (This value corresponds to 4 mA DC output.) If Transmission output 1 high limit and low limit are set to the same value, Transmission output 1 will be fixed at 4 mA DC. • Available only when Transmission output 1 (TA option) or Transmission output 2 (TA2 option) is ordered. • Setting range: If 4E□□ (Resistivity Transmission) is selected in [Transmission output 1 type]: Resistivity range low limit to Transmission output 1 high limit (*1) If TEMP (Temperature Transmission) is selected in [Transmission output 1 type]: 0.0°C to Transmission output 1 high limit (*2) 	Resistivity transmission: 0.00 MΩ•cm Temperature transmission: 0.0°C
Trd2 TEMP	Transmission output 2 type <ul style="list-style-type: none"> • Selects Transmission output 2 type. • If OFF□ (No temperature compensation) is selected in [Temperature compensation method (p.28)], and if TEMP (Temperature transmission) is selected, Transmission output 2 value will differ depending on the selection in [Temperature Display when no temperature compensation (p.33)] as follows. <ul style="list-style-type: none"> • If OFF□ (Unlit) or Ref□ (Reference temperature) is selected, the value set in [Reference temperature (p.29)] will be output. • If PV□ (Measured value) is selected, the measured value will be output. • Available only when Transmission output 2 (TA2 option) is ordered. • 4E□□: Resistivity transmission TEMP: Temperature transmission 	Temperature transmission

(*1) The measurement unit and decimal point place follow the measurement range.

(*2) The decimal point place does not follow the selection. It is fixed.

Character	Setting Item, Function, Setting Range	Factory Default
r r H 2 1000	Transmission output 2 high limit <ul style="list-style-type: none"> Sets the Transmission output 2 high limit value. (This value corresponds to 20 mA DC output.) If Transmission output 2 high limit and low limit are set to the same value, Transmission output 2 will be fixed at 4 mA DC. Available only when Transmission output 2 (TA2 option) is ordered. Setting range: If $r E \square \square$ (Resistivity Transmission) is selected in [Transmission output 2 type]: Transmission output 2 low limit to Resistivity range high limit (*1) If $r E \bar{r} P$ (Temperature Transmission) is selected in [Transmission output 2 type]: Transmission output 2 low limit to 100.0°C (*2) 	Resistivity transmission: 20.00 MΩ·cm Temperature transmission: 100.0°C
r r L 2 □□00	Transmission output 2 low limit <ul style="list-style-type: none"> Sets the Transmission output 2 low limit value. (This value corresponds to 4 mA DC output.) If Transmission output 2 high limit and low limit are set to the same value, Transmission output 2 will be fixed at 4 mA DC. Available only when Transmission output 2 (TA2 option) is ordered. Setting range: If $r E \square \square$ (Resistivity Transmission) is selected in [Transmission output 2 type]: Resistivity range low limit to Transmission output 2 high limit (*1) If $r E \bar{r} P$ (Temperature Transmission) is selected in [Transmission output 2 type]: 0.0°C to Transmission output 2 high limit (*2) 	Resistivity transmission: 0.00 MΩ·cm Temperature transmission: 0.0°C
r r c 1 b E F H	Transmission output 1 status when calibrating <ul style="list-style-type: none"> Selects Transmission output 1 status when calibrating resistivity. Available only when Transmission output 1 (TA option) or Transmission output 2 (TA2 option) is ordered. $b E F H$: Last value HOLD (Retains the last value before resistivity calibration, and outputs it.) $r E F H$: Set value HOLD (Outputs the value set in [Transmission output 1 value HOLD when calibrating].) $P H \square$: Measured value (Outputs the measured value when calibrating resistivity.) 	Last value HOLD
r r 4 1 □000	Transmission output 1 value HOLD when calibrating <ul style="list-style-type: none"> Sets Transmission output 1 value HOLD. Available only when $r E F H$ (Set value HOLD) is selected in [Transmission output 1 status when calibrating]. Setting range: If $r E \square \square$ (Resistivity Transmission) is selected in [Transmission output 1 type]: Resistivity range low limit to Resistivity range high limit (*1) If $r E \bar{r} P$ (Temperature Transmission) is selected in [Transmission output 1 type]: 0.0 to 100.0°C (*2) 	Resistivity transmission: 0.00 MΩ·cm Temperature transmission: 0.0°C
r r c 2 b E F H	Transmission output 2 status when calibrating <ul style="list-style-type: none"> Selects Transmission output 2 status when calibrating resistivity. Available only when Transmission output 2 (TA2 option) is ordered. $b E F H$: Last value HOLD (Retains the last value before resistivity calibration, and outputs it.) $r E F H$: Set value HOLD (Outputs the value set in [Transmission output 2 value HOLD when calibrating].) $P H \square$: Measured value (Outputs the measured value when calibrating resistivity.) 	Last value HOLD

(*1) The measurement unit and decimal point place follow the measurement range.

(*2) The decimal point place does not follow the selection. It is fixed.

Character	Setting Item, Function, Setting Range	Factory Default															
7742 0000	Transmission output 2 value HOLD when calibrating <ul style="list-style-type: none"> Sets Transmission output 2 value HOLD. Available only when 4E7H (Set value HOLD) is selected in [Transmission output 2 status when calibrating]. Setting range <ul style="list-style-type: none"> If 4E00 (Resistivity Transmission) is selected in [Transmission output 2 type]: Resistivity range low limit to Resistivity range high limit (*1) If 7E7P (Temperature Transmission) is selected in [Transmission output 2 type]: 0.0 to 100.0°C (*2) 	Resistivity transmission: 0.00 MΩ·cm Temperature transmission: 0.0°C															
LI0F 0000	Auto-light function <ul style="list-style-type: none"> Selects Auto-light Enabled/Disabled. 0000 : Disabled U4E0 : Enabled 	Disabled															
d14P ALL0	Display selection <ul style="list-style-type: none"> Selects items to be indicated on the Resistivity Display (CH1) and Temperature Display (CH2). Selection range: <table border="1" data-bbox="379 831 1310 1025"> <thead> <tr> <th></th> <th>Resistivity Display (CH1)</th> <th>Temperature Display (CH2)</th> </tr> </thead> <tbody> <tr> <td>ALL0</td> <td>Resistivity</td> <td>Temperature</td> </tr> <tr> <td>4E00</td> <td>Resistivity</td> <td>No indication</td> </tr> <tr> <td>7E7P</td> <td>No indication</td> <td>Temperature</td> </tr> <tr> <td>nonE</td> <td>No indication</td> <td>No indication</td> </tr> </tbody> </table> 		Resistivity Display (CH1)	Temperature Display (CH2)	ALL0	Resistivity	Temperature	4E00	Resistivity	No indication	7E7P	No indication	Temperature	nonE	No indication	No indication	Resistivity/Temperature
	Resistivity Display (CH1)	Temperature Display (CH2)															
ALL0	Resistivity	Temperature															
4E00	Resistivity	No indication															
7E7P	No indication	Temperature															
nonE	No indication	No indication															
717E 0000	Indication time <ul style="list-style-type: none"> Sets the indication time of the displays from no key operation until displays turn off. Displays remain lit when set to 00.00. If any key is pressed while in unlit status, the display will light. Not available if nonE (No indication) is selected in [Display selection]. Setting range: <ul style="list-style-type: none"> 00.00 (Remains lit) 00.01 to 60.00 (Minutes.Seconds) 	00.00															
0FdP 0FF0	Temperature Display when no temperature compensation <ul style="list-style-type: none"> Selects an item to be indicated on the Temperature Display (CH2) when 0FF0 (No temperature compensation) is selected in [Temperature compensation method]. The placement of the decimal point for the reference temperature follows the selection. Available only when 0FF0 (No temperature compensation) is selected in [Temperature compensation method]. 0FF0: Unlit 4Fd0: Reference temperature Pb00: Measured value 	Unlit															

(*1) The measurement unit and decimal point place follow the measurement range.

(*2) The decimal point place does not follow the selection. It is fixed.

Character	Setting Item, Function, Setting Range	Factory Default
A1oF A10	A1 output allocation <ul style="list-style-type: none"> • Selects A1 output allocation. For A1 output, A11 type, A12 type, A21 type and/or A22 type are allocated. Output is OR output. • Not available if Transmission output 2 (TA2 option) is ordered. • A10 : A11 type A12 : A12 type A21 : A21 type A22 : A22 type A1A1 : A11, A12 types A2A1 : A21, A22 types A1A2 : A11, A21 types A2A2 : A12, A22 types ALL : A11, A12, A21, A22 types 	A11 type
A2oF A20	A2 output allocation <ul style="list-style-type: none"> • Selects A2 output allocation. For A2 output, A11 type, A12 type, A21 type and/or A22 type are allocated. Output is OR output. • Not available if Transmission output 1 (TA option) or Transmission output 2 (TA2 option) is ordered. • For the selection item, refer to [A1 output allocation]. (p.34) 	A21 type
oan1 0000	Output ON time when A1 output ON <ul style="list-style-type: none"> • Sets Output ON time when A1 output is ON. If Output ON time and OFF time are set, A1 output can be turned ON/OFF in a configured cycle when A1 output is ON. (Fig. 8.4-1) • Not available if Transmission output 2 (TA2 option) is ordered. • Setting range: 0 to 9999 seconds <p style="text-align: center;">Timing chart (Output ON time and OFF time when A1 output is ON)</p> <p style="text-align: center;">(Fig. 8.4-1)</p>	0 seconds
oof1 0000	Output OFF time when A1 output ON <ul style="list-style-type: none"> • Sets Output OFF time when A1 output is ON. If Output ON time and OFF time are set, A1 output can be turned ON/OFF in a configured cycle when A1 output is ON. (Fig. 8.4-1) (p.34) • Not available if Transmission output 2 (TA2 option) is ordered. • Setting range: 0 to 9999 seconds 	0 seconds

Character	Setting Item, Function, Setting Range	Factory Default
00n2 □□□□	Output ON time when A2 output ON <ul style="list-style-type: none"> Sets Output ON time when A2 output is ON. If Output ON time and OFF time are set, A2 output can be turned ON/OFF in a configured cycle when A2 output is ON. (Fig. 8.4-1) (p.34) Not available if Transmission output 1 (TA option) or Transmission output 2 (TA2 option) is ordered. Setting range: 0 to 9999 seconds 	0 seconds
00F2 □□□□	Output OFF time when A2 output ON <ul style="list-style-type: none"> Sets Output OFF time when A2 output is ON. If Output ON time and OFF time are set, A2 output can be turned ON/OFF in a configured cycle when A2 output is ON. (Fig. 8.4-1) (p.34) Not available if Transmission output 1 (TA option) or Transmission output 2 (TA2 option) is ordered. Setting range: 0 to 9999 seconds 	0 seconds
R14□ □-□-□	A1 resistivity input error alarm A□□ type <ul style="list-style-type: none"> Selects A□□ output type in order to assess A1 resistivity input error alarm. Not available if Transmission output 2 (TA2 option) is ordered. □-□-□ : No action R11□ : A11 type R12□ : A12 type R21□ : A21 type R22□ : A22 type 	No action
R24□ □-□-□	A2 resistivity input error alarm A□□ type <ul style="list-style-type: none"> Selects A□□ output type in order to assess A2 resistivity input error alarm. Not available if Transmission output 1 (TA option) or Transmission output 2 (TA2 option) is ordered. For the selection item, refer to [A1 resistivity input error alarm A□□ type]. (p.35) 	No action
R14□ □□□□	A1 resistivity input error alarm band when A□□ output ON <ul style="list-style-type: none"> Sets band to assess A1 resistivity input error alarm when A□□ output is ON. Refer to 'Resistivity Input Error Alarm' on p.37. Not available if □-□-□ (No action) is selected in [A1 resistivity input error alarm A□□ type]. Not available if Transmission output 2 (TA2 option) is ordered. Setting range: Resistivity range low limit to Resistivity range high limit (*1) When set to 0.00, Resistivity input error alarm is disabled. 	0.00 MΩ·cm
R1aF □□□□	A1 resistivity input error alarm time when A□□ output ON <ul style="list-style-type: none"> Sets time to assess A1 resistivity input error alarm when A□□ output is ON. Refer to 'Resistivity Input Error Alarm' on p.37. Not available if □-□-□ (No action) is selected in [A1 resistivity input error alarm A□□ type]. Not available if Transmission output 2 (TA2 option) is ordered. Setting range: 0 to 9999 seconds or minutes (*2) When set to 0, Resistivity input error alarm is disabled. 	0 seconds

(*1) The measurement unit and decimal point place follow the measurement range.

(*2) The time unit follows the selection in [Resistivity input error alarm time unit].

Character	Setting Item, Function, Setting Range	Factory Default
R14c □□□□	A1 resistivity input error alarm band when A□□ output OFF <ul style="list-style-type: none"> • Sets band to assess A1 resistivity input error alarm when A□□ output is OFF. Refer to 'Resistivity Input Error Alarm' on p.37. • Not available if □□□□ (No action) is selected in [A1 resistivity input error alarm A□□ type]. Not available if Transmission output 2 (TA2 option) is ordered. • Setting range: Resistivity range low limit to Resistivity range high limit (*1) When set to 0.00, Resistivity input error alarm is disabled. 	0.00 MΩ•cm
R1cF □□□□	A1 resistivity input error alarm time when A□□ output OFF <ul style="list-style-type: none"> • Sets time to assess A1 resistivity input error alarm when A□□ output is OFF. Refer to 'Resistivity Input Error Alarm' on p.37. • Not available if □□□□ (No action) is selected in [A1 resistivity input error alarm A□□ type]. Not available if Transmission output 2 (TA2 option) is ordered. • Setting range: 0 to 9999 seconds or minutes (*2) When set to 0, Resistivity input error alarm is disabled. 	0 seconds
R24c □□□□	A2 resistivity input error alarm band when A□□ output ON <ul style="list-style-type: none"> • Sets band to assess A2 resistivity input error alarm when A□□ output is ON. Refer to 'Resistivity Input Error Alarm' on p.37. • Not available if □□□□ (No action) is selected in [A2 resistivity input error alarm A□□ type]. Not available if Transmission output 1 (TA option) or Transmission output 2 (TA2 option) is ordered. • Setting range: Resistivity range low limit to Resistivity range high limit (*1) When set to 0.00, Resistivity input error alarm is disabled. 	0.00 MΩ•cm
R2cF □□□□	A2 resistivity input error alarm time when A□□ output ON <ul style="list-style-type: none"> • Sets time to assess A2 resistivity input error alarm when A□□ output is ON. Refer to 'Resistivity Input Error Alarm' on p.37. • Not available if □□□□ (No action) is selected in [A2 resistivity input error alarm A□□ type]. Not available if Transmission output 1 (TA option) or Transmission output 2 (TA2 option) is ordered. • Setting range: 0 to 9999 seconds or minutes (*2) When set to 0, Resistivity input error alarm is disabled. 	0 seconds
R24c □□□□	A2 resistivity input error alarm band when A□□ output OFF <ul style="list-style-type: none"> • Sets band to assess A2 resistivity input error alarm when A□□ output is OFF. Refer to 'Resistivity Input Error Alarm' on p.37. • Not available if □□□□ (No action) is selected in [A2 resistivity input error alarm A□□ type]. Not available if Transmission output 1 (TA option) or Transmission output 2 (TA2 option) is ordered. • Setting range: Resistivity range low limit to Resistivity range high limit (*1) When set to 0.00, Resistivity input error alarm is disabled. 	0.00 MΩ•cm

(*1) The measurement unit and decimal point place follow the measurement range.

(*2) The time unit follows the selection in [Resistivity input error alarm time unit].

Character	Setting Item, Function, Setting Range	Factory Default
A2eF □□□□	A2 resistivity input error alarm time when A□□ output OFF <ul style="list-style-type: none"> • Sets time to assess A2 resistivity input error alarm when A□□ output is OFF. Refer to 'Resistivity Input Error Alarm' on p.37. • Not available if □□□□ (No action) is selected in [A2 resistivity input error alarm A□□ type]. • Not available if Transmission output 1 (TA option) or Transmission output 2 (TA2 option) is ordered. • Setting range: 0 to 9999 seconds or minutes (*) • When set to 0, Resistivity input error alarm is disabled. 	0 seconds
n_4□ 4E□□	Resistivity input error alarm time unit <ul style="list-style-type: none"> • Selects resistivity input error alarm time unit. • Selection item • 4E□□ : Second(s) • n_1 n□ : Minute(s) 	Second(s)
rcUF oFF□	Measurement range cut function <ul style="list-style-type: none"> • Selects either Disabled or Enabled of the Measurement range cut function. Resistivity range high limit value will be indicated when resistivity measured value is outside the measurement range. • Selection item • oFF□ : Disabled • on□□ : Enabled 	Disabled

(*) The measurement unit and decimal point place follow the measurement range.

Resistivity Input Error Alarm

Resistivity input error alarm is used for detecting actuator trouble.

Even if resistivity input error alarm time has elapsed, and if resistivity input does not become higher than resistivity input error alarm band, the unit assumes that actuator trouble has occurred, and sets Status flag 2 (EVT1, EVT2, EVT3, EVT4 output flag bit).

In Serial communication, status can be read by reading Status flag 2 (A1, A2 resistivity input error alarm output flag bit).

Resistivity input error alarm is disabled during Resistivity calibration Span adjustment.

Resistivity input error alarm is enabled only when 4E_L (Resistivity input low limit action), 4E_H (Resistivity input high limit action) is selected in [A11 type], [A12 type], [A21 type] or [A22 type]. (pp. 22, 23)

9. Calibration

Resistivity Calibration Span Adjustment mode, Temperature Calibration mode and Transmission output 1 and 2 adjustment modes are described below.



9.1 Resistivity Calibration Span Adjustment Mode

Deterioration of the 2-electrode Resistivity Sensor might cause the cell constant to change. To correct the changed cell constant, calibration is required.

Correction value is adjusted so that the resistivity matches a reference resistivity meter.



During Resistivity Calibration Span Adjustment, A□□ action is forced OFF.

The following outlines the procedure for Resistivity Calibration Span Adjustment.

- ① Press and hold the  key and  key (in that order) together for approx. 3 seconds in Resistivity/Temperature Display Mode.

The unit enters Resistivity Calibration Span Adjustment mode, and indicates the following.

Display	Indication
Resistivity Display (CH1)	Adj and resistivity input value are displayed alternately.
Temperature Display (CH2)	Resistivity Span adjustment value

- ② Set the Resistivity Span adjustment value with the  or  key, while checking the reference resistivity meter.

Resistivity span adjustment value: 0.700 to 1.300

- ③ Press the  key.

Resistivity span adjustment value will be registered, and the unit reverts to Resistivity/Temperature Display Mode.

9.2 Temperature Calibration Mode

To calibrate a temperature, set a temperature calibration value.

When a sensor cannot be set at the exact location where measurement is desired, the resulting measured temperature may deviate from the temperature in the desired location. In such a case, the desired temperature can be set for the desired location by setting a temperature calibration value. However, it is only effective within the input rated range regardless of the temperature calibration value.



Temperature after calibration = Current temperature + (Temperature calibration value)

(e.g.) When current temperature is 23.5°C,

If temperature calibration value is set to 1.5°C: $23.5 + (1.5) = 25.0^\circ\text{C}$

If temperature calibration value is set to -1.5°C: $23.5 + (-1.5) = 22.0^\circ\text{C}$

The following outlines the procedure for Temperature calibration.

- ① Press and hold the  key and  key (in that order) together for approx. 3 seconds in Resistivity/Temperature Display Mode.

The unit will proceed to Temperature Calibration mode, and indicates the following.

Display	Indication
Resistivity Display (CH1)	Adj and temperature are displayed alternately.
Temperature Display (CH2)	Temperature calibration value.

- ② Set a temperature calibration value with the  or  key, while checking temperature.

Setting range: -10.0 to 10.0°C

- ③ Press the  key.

Temperature calibration is complete, and the unit reverts to Resistivity/Temperature Display Mode.

9.3 Transmission Output 1 Adjustment Mode

Fine adjustment of Transmission output 1 is performed.

The WIL-102-SE is adjusted at the factory, however, differences may occur between the indication value of the connected equipment (recorders, etc.) and output value of this instrument.

In this case, perform Transmission output 1 Zero adjustment and Span adjustment.

Available when Transmission output 1 (TA option) or Transmission output 2 (TA2 option) is ordered.

The unit cannot enter Transmission output 1 Zero adjustment mode in the following cases:



- During Resistivity calibration Span adjustment or Temperature calibration
- When $LOC\ 1$ (Lock 1), $LOC\ 2$ (Lock 2) or $LOC\ 3$ (Lock 3) is selected in [Set value lock (p.30)]

The following outlines the procedure for Transmission output 1 adjustment.

- ① Press and hold the  key and  key (in that order) together for 3 seconds in Resistivity/Temperature Display Mode.

The unit enters Transmission output 1 Zero adjustment mode, and indicates the following.



Display	Indication
Resistivity Display (CH1)	$Adj\ 1$
Temperature Display (CH2)	Transmission output 1 Zero adjustment value

- ② Set a Transmission output 1 Zero adjustment value with the  or  key, while viewing the value indicated on the connected equipment (recorders, etc.).
Setting range: $\pm 5.00\%$ of Transmission output 1 span

- ③ Press the  key.

The unit enters Transmission output 1 Span adjustment mode, and indicates the following.

Display	Indication
Resistivity Display (CH1)	$Adj\ 1$
Temperature Display (CH2)	Transmission output 1 Span adjustment value

- ④ Set a Transmission output 1 Span adjustment value with the  or  key, while viewing the value indicated on the connected equipment (recorders, etc.).
Setting range: $\pm 5.00\%$ of Transmission output 1 span

- ⑤ Press the  key.

The unit reverts to Transmission output 1 Zero adjustment mode.

Repeat steps ② to ⑤ if necessary.

- ⑥ To finish Transmission output 1 adjustment, press the  key in Transmission output 1 Span adjustment mode.

The unit reverts to Resistivity/Temperature Display Mode.

9.4 Transmission Output 2 Adjustment Mode

Fine adjustment of Transmission output 2 is performed.

The WIL-102-SE is adjusted at the factory, however, differences may occur between the indication value of the connected equipment (recorders, etc.) and output value of this instrument.

In this case, perform Transmission output 2 Zero adjustment and Span adjustments.

Available only when Transmission output 2 (TA2 option) is ordered.

The unit cannot enter Transmission output 2 Zero adjustment mode in the following cases:



- During Resistivity calibration Span adjustment or Temperature calibration
- When $LOC\ 1$ (Lock 1), $LOC\ 2$ (Lock 2) or $LOC\ 3$ (Lock 3) is selected in [Set value lock (p.30)]

The following outlines the procedure for Transmission output 2 adjustment.

- ① Press and hold the  key and  key (in that order) together for 3 seconds in Resistivity/Temperature Display Mode.

The unit enters Transmission output 2 Zero adjustment mode, and indicates the following.



Display	Indication
Resistivity Display (CH1)	0.00
Temperature Display (CH2)	Transmission output 2 Zero adjustment value

- ② Set a Transmission output 2 Zero adjustment value with the  or  key, while viewing the value indicated on the connected equipment (recorders, etc.).
Setting range: $\pm 5.00\%$ of Transmission output 2 span

- ③ Press the  key.

The unit enters Transmission output 2 Span adjustment mode, and indicates the following.

Display	Indication
Resistivity Display (CH1)	0.00
Temperature Display (CH2)	Transmission output 2 Span adjustment value

- ④ Set a Transmission output 2 Span adjustment value with the  or  key, while viewing the value indicated on the connected equipment (recorders, etc.).
Setting range: $\pm 5.00\%$ of Transmission output 2 span

- ⑤ Press the  key.

The unit reverts to Transmission output 2 Zero adjustment mode.

Repeat steps ② to ⑤ if necessary.

- ⑥ To finish Transmission output 2 adjustment, press the  key in Transmission output 2 Span adjustment mode.

The unit reverts to Resistivity/Temperature Display Mode.

10. Measurement

10.1 Starting Measurement

After mounting to the control panel, and if wiring, setup and calibration are complete, turn the power to the instrument ON.

For approx. 4 seconds after the power is switched ON, the input characters are indicated on the Resistivity Display (CH1) and Temperature Display (CH2). See (Table 10.1-1).

(Table 10.1-1)

Display	Character	Measurement Unit	
Resistivity Display (CH1)	<i>CONd</i>	Resistivity (MΩ·cm)	
	<i>41</i> □□	Resistivity (kΩ·m)	
Display	Character	Input Temperature Spec (*)	[Pt100 Input Wire Type] Selection Item (p.29)
Temperature Display (CH2)	<i>PT02</i>	Pt100	<i>PT02</i> : 2-wire type
	<i>PT03</i>		<i>PT03</i> : 3-wire type
	<i>PT10</i>	Pt1000	

(*) This input temperature specification was specified at the time of ordering.

During this time, all outputs are in OFF status, and LED indicators except the PWR Indicator are turned off. After that, measurement starts, indicating the item selected in [Display selection (p.33)].

10.2 A□□ Output

When *LE_L* (Resistivity input low limit action), *LE_H* (Resistivity input high limit action), *TE_PL* (Temperature input low limit action) or *TE_PH* (Temperature input high limit action) is selected in [A11, A12, A21, A22 type (pp. 22, 23)], the A□□ output is turned ON if the measured value exceeds the A□□ value.

When *LEHL* (Resistivity input High/Low limits independent action), *TEHL* (Temperature input High/Low limits independent action) is selected in [A11, A12, A21, A22 type (pp. 22, 23)], the A□□ output is turned ON if the measured value exceeds the A□□ High/Low limits independent action upper side span, or drops below the lower side span.

A1 or A2 output turns ON depending on the selection in [A1/A2 output allocation (p.34)], and [Output ON time/OFF time when A1 or A2 output ON (pp.34, 35)].

If Output ON time and OFF time are set, A1 or A2 output can be turned ON/OFF in a configured cycle while A1 or A2 output is ON. See (Fig. 10.2-1).

Timing chart (Output ON time and OFF time when A1 output is ON)

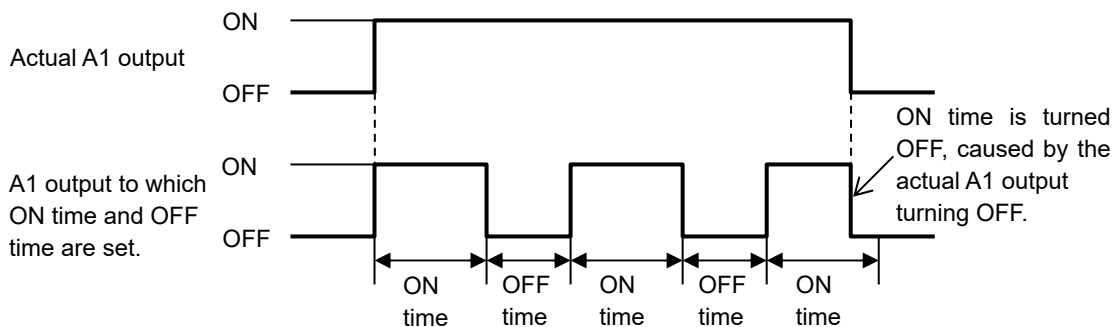

(Fig. 10.2-1)

Output status can be read via the status flag (A11, A12, A21, A22 output flag bit) in Serial Communication. A□□ output status differs depending on the selection in [A□□ output when input errors occur (p.28)] when input errors occur.

- If *OFF* (Disabled) is selected in [A□□ output when input errors occur (p.28)], A□□ output and A□□ action status will be turned OFF when input errors occur.
- If *ON* (Enabled) is selected in [A□□ output when input errors occur (p.28)], A□□ output and A□□ action status will be maintained when input errors occur.

10.3 Resistivity Input Error Alarm

Resistivity input error alarm is used for detecting actuator trouble.

Even if resistivity input error alarm time (pp.35 to 37) has elapsed, and if resistivity input does not become higher than resistivity input error alarm band, the unit assumes that actuator trouble has occurred, and sets Status flag 2.

In Serial communication, status can be read by reading Status flag 2 (A1, A2 resistivity input error alarm output flag bit).

Resistivity input error alarm is disabled in the following cases.

- During resistivity calibration Span adjustment
- When LE_L (Resistivity input low limit action), LE_H (Resistivity input high limit action) is not selected in [A11 type], [A12 type], [A21 type], [A22 type]. (pp. 22, 23)

10.4 Error Output

If EO (Error Output) is selected in [A11, A12, A21, A22 Type (pp. 22, 23)], the A1 or A2 output will be turned ON when error type is “Error”.

10.5 Fail Output

If FO (Fail Output) is selected in [A11, A12, A21, A22 Type (pp. 22, 23)], the A1 or A2 output will be turned ON when error type is “Fail”.

10.6 Error Code during Measurement

For Temperature sensor error or Outside temperature compensation range during measurement, their corresponding error codes flash on the Temperature Display as shown below in (Table 10.5-1).

(Table 10.5-1)

Error Code	Error Type	Error	Description	Occurrence
E01	Fail	Temperature sensor burnout	Temperature sensor lead wire is burnt out.	When measuring or calibrating
E02	Fail	Temperature sensor short-circuited	Temperature sensor lead wire is short-circuited.	
E03	Error	Outside temperature compensation range	Measured temperature has exceeded 110.0°C.	
E04	Error	Outside temperature compensation range	Measured temperature is less than 0.0°C.	

10.7 Transmission Output 1 and 2

Converting resistivity or temperature to analog signal every input sampling period, outputs in current. (Factory default: Transmission output 1: Resistivity, Transmission output 2: Temperature)

If OFF (No temperature compensation) is selected in [Temperature compensation method (p.28)], and if TEMP (Temperature transmission) is selected in [Transmission output 1 type (p.31)] or in [Transmission output 2 type (p.31)], Transmission output 1 or 2 value differs depending on the selection in [Temperature Display when no temperature compensation (p.33)].

- If OFF (Unlit) or REF (Reference temperature) is selected, the value set in [Reference temperature (p.29)] will be output.
- If PH (Measured value) is selected, the measured value will be output.

If Transmission output 1 high limit and low limit are set to the same value, Transmission output 1 will be fixed at 4 mA DC.

If Transmission output 2 high limit and low limit are set to the same value, Transmission output 2 will be fixed at 4 mA DC.

Resolution	12000
Current	4 to 20 mA DC (Load resistance: Max. 550 Ω)
Output accuracy	Within $\pm 0.3\%$ of Transmission output 1 or 2 span

11. Communication

11.1 System Configuration Example

- When using the USB Communication Cable CMC-001-3 (sold separately)

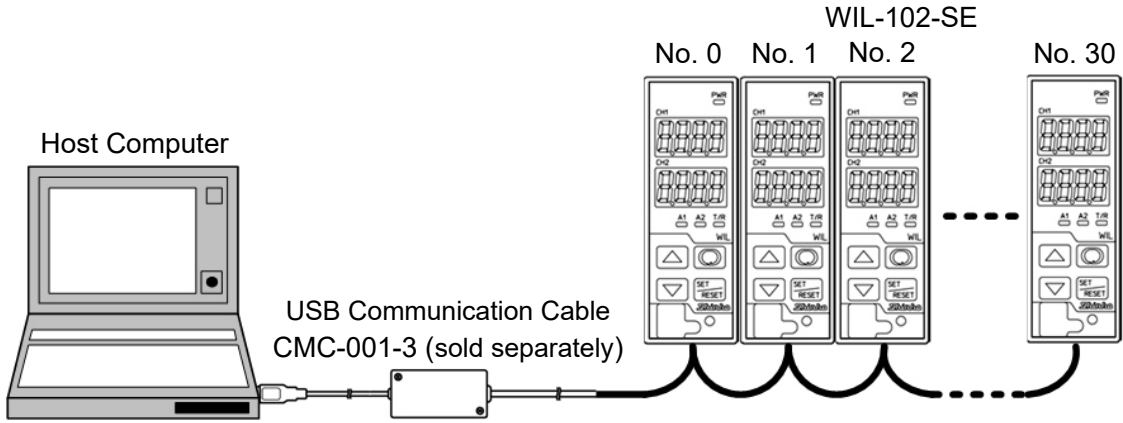

(Fig. 11.1-1)

- When using the Communication Converter IF-400 (sold separately)

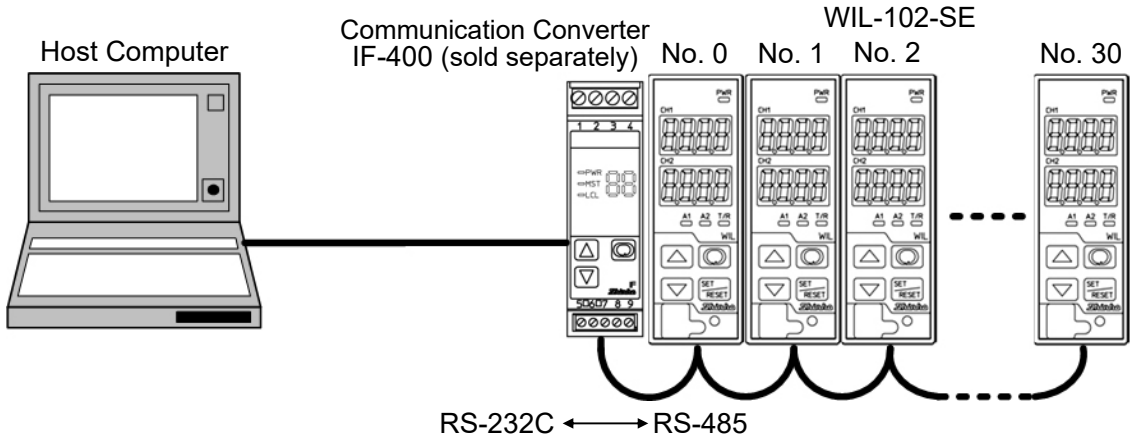













(Fig. 11.1-2)

11.2 Setting Method of This Instrument

Communication parameters can be set in the Basic Function Group.

To enter the Basic Function Group, follow the procedure below.

- ① *OFF* Press the  key 3 times in Resistivity/Temperature Display Mode.
- ② *cnL* Press the  key twice. 'Communication Protocol' will appear.
- ③ Set each items. (Use the  or  key for settings, and register the value with the  key.)

Character	Setting Item, Function, Setting Range	Factory Default
<i>cnL</i> <i>noL</i>	Communication protocol <ul style="list-style-type: none"> • Selects communication protocol. • <i>noL</i> : Shinko protocol • <i>noA</i> : MODBUS ASCII mode • <i>noR</i> : MODBUS RTU mode 	Shinko protocol
<i>cnno</i> 	Instrument number <ul style="list-style-type: none"> • Sets the instrument number. The instrument numbers should be set one by one when multiple instruments are connected in Serial communication, otherwise communication is impossible. • Setting range: 0 to 95 	0
<i>cnP</i> 	Communication speed <ul style="list-style-type: none"> • Selects a communication speed equal to that of the host computer. •  : 9600 bps •  : 19200 bps •  : 38400 bps 	9600 bps
<i>cnP</i> <i>7EBn</i>	Data bit/Parity <ul style="list-style-type: none"> • Selects data bit and parity. • <i>8non</i> : 8 bits/No parity • <i>7non</i> : 7 bits/No parity • <i>8EBn</i> : 8 bits/Even • <i>7EBn</i> : 7 bits/Even • <i>8odd</i> : 8 bits/Odd • <i>7odd</i> : 7 bits/Odd 	7 bits/Even
<i>cnL</i> 	Stop bit <ul style="list-style-type: none"> • Selects the stop bit. •  : 1 bit •  : 2 bits 	1 bit

- ④ Press the  key multiple times. The unit reverts to Resistivity/Temperature Display Mode.

11.3 Communication Procedure

Communication starts with command transmission from the host computer (hereafter Master) and ends with the response of the WIL-102-SE (hereafter Slave).

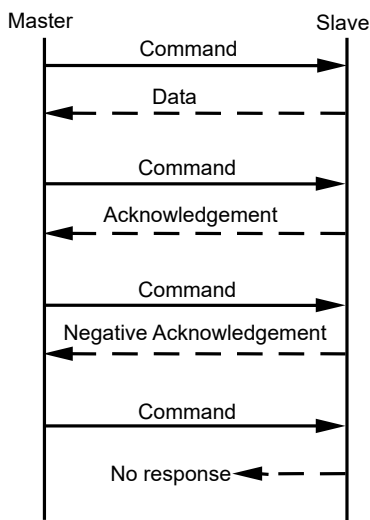

(Fig.11.3-1)

• Response with Data

When the master sends the reading command, the slave responds with the corresponding set value or current status.

• Acknowledgement

When the master sends the setting command, the slave responds by sending acknowledgement after the processing is terminated.

• Negative Acknowledgement

When the master sends a non-existent command or value out of the setting range, the slave returns a negative acknowledgement.

• No Response

The slave will not respond to the master in the following cases:

- Global address (Shinko protocol) is set.
- Broadcast address (MODBUS protocol) is set.
- Communication error (framing error, parity error)
- Checksum error (Shinko protocol), LRC discrepancy (MODBUS ASCII mode), CRC-16 discrepancy (MODBUS RTU mode)

Communication Timing of the RS-485

Master Side (Take note while programming)

When the master starts transmission through the RS-485 communication line, the master is arranged so as to provide an idle status (mark status) transmission period of 1 or more characters before sending the command to ensure synchronization on the receiving side.

Set the program so that the master can disconnect the transmitter from the communication line within a 1 character transmission period after sending the command in preparation for reception of the response from the slave.

To avoid collision of transmissions between the master and the slave, send the next command after carefully checking that the master has received the response.

If a response to the command is not returned due to communication errors, set the Retry Processing to send the command again. (It is recommended to execute Retry twice or more.)

Slave Side

When the slave starts transmission through the RS-485 communication line, the slave is arranged so as to provide an idle status (mark status) transmission period of 1 or more characters before sending the response to ensure synchronization on the receiving side.

The slave is arranged so as to disconnect the transmitter from the communication line within a 1 character transmission period after sending the response.

11.4 Shinko Protocol

11.4.1 Transmission Mode

Shinko protocol is composed of ASCII.

Hexadecimal (0 to 9, A to F), which is divided into high order (4-bit) and low order (4-bit) out of 8-bit binary data in command is transmitted as ASCII characters.

Data format Start bit: 1 bit
 Data bit: 7 bits
 Parity: Even
 Stop bit: 1 bit

Error detection: Checksum

11.4.2 Command Configuration

All commands are composed of ASCII.

The data (set value, decimal number) is represented by a hexadecimal number.

The negative numbers are represented in 2's complement.

Numerals written below the command represent number of characters.

(1) Setting Command

Header (02H)	Address	Sub address (20H)	Command type (50H)	Data item	Data	Checksum	Delimiter (03H)
1	1	1	1	4	4	2	1

(Fig. 11.4.2-1)

(2) Reading Command

Header (02H)	Address	Sub address (20H)	Command type (20H)	Data item	Checksum	Delimiter (03H)
1	1	1	1	4	2	1

(Fig. 11.4.2-2)

(3) Response with Data

Header (06H)	Address	Sub address (20H)	Command type (20H)	Data item	Data	Checksum	Delimiter (03H)
1	1	1	1	4	4	2	1

(Fig. 11.4.2-3)

(4) Acknowledgement

Header (06H)	Address	Checksum	Delimiter (03H)
1	1	2	1

(Fig. 11.4.2-4)

(5) Negative Acknowledgement

Header (15H)	Address	Error code	Checksum	Delimiter (03H)
1	1	1	2	1

(Fig. 11.4.2-5)

Header: Control code to represent the beginning of the command or the response.

ASCII is used.

Setting command, Reading command: STX (02H) fixed.

Response with data, Acknowledgement: ACK (06H) fixed.

Negative acknowledgement: NAK (15H) fixed.

Instrument Number (Address): Numbers by which the master discerns each slave.

Instrument numbers 0 to 94 and Global address 95.

ASCII (20H to 7FH) is used by adding 20H to instrument numbers 0 to 95 (00H to 5FH).

95 (7FH) is called Global address, which is used when the same command is sent to all the slaves connected. However, the response is not returned.

Sub Address: 20H fixed.

Command Type: Code to discern Setting command (50H) and Reading command (20H)

- Data Item:** Classification of the command object.
Composed of 4-digit hexadecimal numbers, using ASCII.
[Refer to "11.6. Communication Command Table". (pp.52 to 60)]
- Data:** The contents of data (values) differ depending on the setting command.
Composed of 4-digit hexadecimal numbers, using ASCII.
[Refer to "11.6. Communication Command Table". (pp.52 to 60)]
- Checksum:** 2-character data to detect communication errors.
[Refer to "11.4.3 Checksum Calculation" (p.47).]
- Delimiter:** Control code to represent the end of command.
ASCII code ETX (03H) fixed.
- Error Code:** Represents an error type using ASCII.
1 (31H)-----Non-existent command
2 (32H)-----Not used
3 (33H)-----Value outside the setting range
4 (34H)-----Status unable to be set (e.g. During calibration mode)
5 (35H)-----During setting mode by keypad operation

11.4.3 Checksum Calculation

Checksum is used to detect receiving errors in the command or data.
Set the program for the master side as well to calculate the checksum of the response data from the slaves so that communication errors can be checked.

The ASCII code (hexadecimal) corresponding to the characters which range from the address to that before the checksum is converted to binary notation, and the total value is calculated.
The lower one byte of the total value is converted to 2's complement, and then to hexadecimal numbers, that is, ASCII code for the checksum.

- 1's complement: Reverse each binary bit. 0 will become 1 and vice versa.
- 2's complement: Add 1 to 1's complement.

Checksum Calculation Example

A11 value: 1.00 (0064H)
Address (instrument number): 0 (20H)

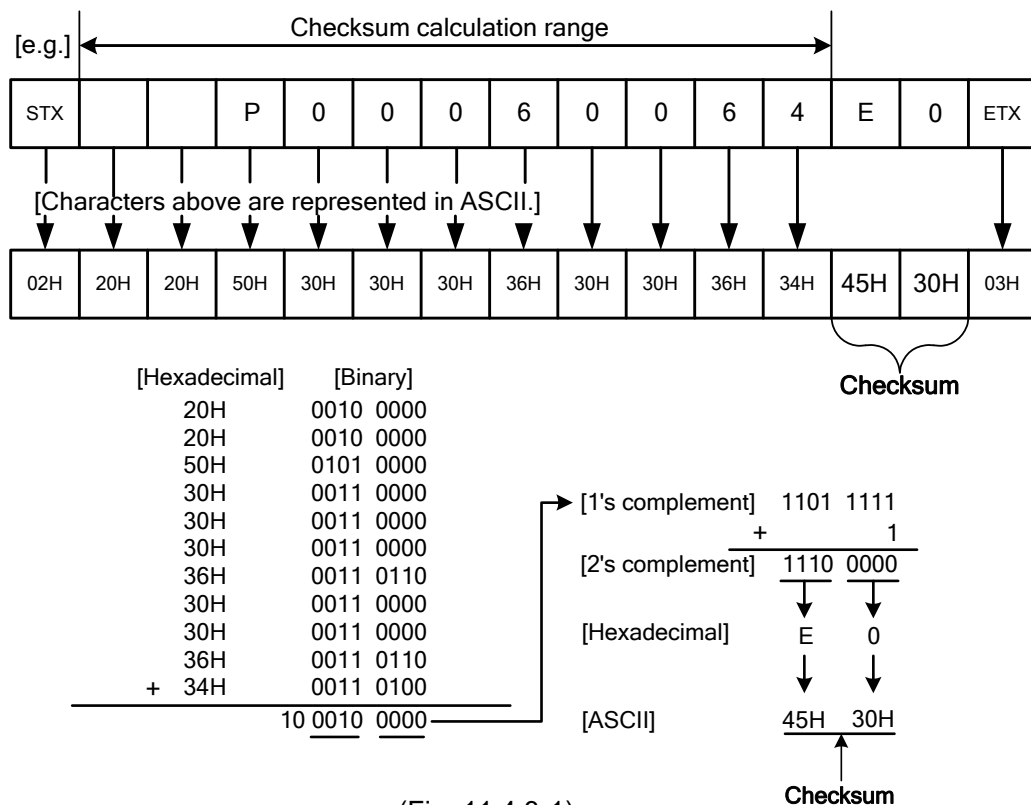

(Fig. 11.4.3-1)

11.5 MODBUS Protocol

11.5.1 Transmission Mode

There are 2 transmission modes (ASCII and RTU) in MODBUS protocol.

ASCII Mode

Hexadecimal (0 to 9, A to F), which is divided into high order (4-bit) and low order (4-bit) out of 8-bit binary data in command is transmitted as ASCII characters.

Data format Start bit: 1 bit
 Data bit: 7 bits (8 bits) (Selectable)
 Parity: Even (No parity, Odd) (Selectable)
 Stop bit: 1 bit (2 bits) (Selectable)
 Error detection : LRC (Longitudinal Redundancy Check)

RTU Mode

8-bit binary data in command is transmitted as it is.

Data format Start bit: 1 bit
 Data bit: 8 bits
 Parity: No parity (Even, Odd) (Selectable)
 Stop bit: 1 bit (2 bits) (Selectable)
 Error detection: CRC-16 (Cyclic Redundancy Check)

11.5.2 Data Communication Interval

ASCII Mode

Max.1 second of interval between ASCII mode characters

RTU Mode

Communication speed 9600 bps, 19200 bps:

To transmit continuously, an interval between characters which consist of one message, must be within 1.5-character transmission times.

Communication speed 38400 bps:

To transmit continuously, an interval between characters which consist of one message, must be within 750 μ s.

If an interval lasts longer than 1.5-character transmission times or 750 μ s, the WIL-102-SE assumes that transmission from the master is finished, which results in a communication error, and will not return a response.

11.5.3 Message Configuration

ASCII Mode

ASCII mode message is configured to start by Header [: (colon)(3AH)] and end by Delimiter [CR (carriage return) (0DH) + LF (Line feed)(0AH)].

Header (:)	Slave Address	Function Code	Data	Error Check LRC	Delimiter (CR)	Delimiter (LF)
---------------	------------------	------------------	------	--------------------	-------------------	-------------------

RTU Mode

Communication speed 9600 bps, 19200 bps: RTU mode is configured to start after idle time is processed for more than 3.5-character transmissions, and end after idle time is processed for more than 3.5-character transmissions.

Communication speed 38400 bps: RTU mode is configured to start after idle time is processed for more than 1.75 ms, and end after idle time is processed for more than 1.75 ms.

3.5 idle characters	Slave Address	Function Code	Data	Error Check CRC-16	3.5 idle characters
------------------------	------------------	------------------	------	-----------------------	------------------------

(1) Slave Address

Slave address is an individual instrument number on the slave side, and is set within the range 0 to 95 (00H to 5FH).

The master identifies slaves by the slave address of the requested message.

The slave informs the master which slave is responding to the master by placing its own address in the response message.

Slave address 00H (Broadcast address) can identify all the slaves connected. However, slaves do not respond.

(2) Function Code

The function code is the command code for the slave to undertake the following action types.

(Table 11.5.3-1)

Function Code	Contents
03 (03H)	Reading the set value and information from slaves
06 (06H)	Setting to slaves

Function code is used to discern whether the response is normal (acknowledgement) or if any error (negative acknowledgement) has occurred when the slave returns the response message to the master. When acknowledgement is returned, the slave simply returns the original function code.

When negative acknowledgement is returned, the MSB of the original function code is set as 1 for the response.

For example, when the master sends request message setting 10H to the function code by mistake, slave returns 90H by setting the MSB to 1, because the former is an illegal function.

For negative acknowledgement, the exception codes below (Table 11.5.3-2) are set to the data of the response message, and returned to the master in order to inform it of what kind of error has occurred.

(Table 11.5.3-2)

Exception Code	Contents
1 (01H)	Illegal function (Non-existent function)
2 (02H)	Illegal data address (Non-existent data address)
3 (03H)	Illegal data value (Value out of the setting range)
17 (11H)	Shinko protocol error code 4 [Status unable to be set, (e.g. During calibration mode)]
18 (12H)	Shinko protocol error code 5 (During setting mode by keypad operation)

(3) Data

Data differs depending on the function code.

A request message from the master is composed of data item, amount of data and setting data.

A response message from the slave is composed of the byte count, data and exception codes in negative acknowledgements.

Effective range of data is -32768 to 32767 (8000H to 7FFFH).

(4) Error Check

ASCII Mode

After calculating LRC (Longitudinal Redundancy Check) from the slave address to the end of data, the calculated 8-bit data is converted to two ASCII characters, and are appended to the end of message.

How to Calculate LRC

- ① Create a message in RTU mode.
- ② Add all the values from the slave address to the end of data. This is assumed as X.
- ③ Make a complement for X (bit reverse). This is assumed as X.
- ④ Add a value of 1 to X. This is assumed as X.
- ⑤ Set X as an LRC to the end of the message.
- ⑥ Convert the whole message to ASCII characters.

RTU Mode

After calculating CRC-16 (Cyclic Redundancy Check) from the slave address to the end of the data, the calculated 16-bit data is appended to the end of message in sequence from low order to high order.

How to calculate CRC-16

In the CRC-16 system, the information is divided by the polynomial series. The remainder is added to the end of the information and transmitted. The generation of a polynomial series is as follows.

(Generation of polynomial series: $X^{16} + X^{15} + X^2 + 1$)

- ① Initialize the CRC-16 data (assumed as X) (FFFFH).
- ② Calculate exclusive OR (XOR) with the 1st data and X. This is assumed as X.
- ③ Shift X one bit to the right. This is assumed as X.
- ④ When a carry is generated as a result of the shift, XOR is calculated by X of ③ and the fixed value (A001H). This is assumed as X. If a carry is not generated, go to step ⑤.
- ⑤ Repeat steps ③ and ④ until shifting 8 times.
- ⑥ XOR is calculated with the next data and X. This is assumed as X.
- ⑦ Repeat steps ③ to ⑤.
- ⑧ Repeat steps ③ to ⑤ up to the final data.
- ⑨ Set X as CRC-16 to the end of message in sequence from low order to high order.

11.5.4 Message Example

ASCII Mode

Numerals written below the command represent the number of characters.

① Reading [Slave address 1, Data item 0080H (Resistivity)]

- A request message from the master

Amount of data means how many data items are to be read. It is fixed as (30H 30H 30H 31H).

Header (3AH)	Slave Address (30H 31H)	Function Code (30H 33H)	Data Item [0080H] (30H 30H 38H 30H)	Amount of Data [0001H] (30H 30H 30H 31H)	Error Check LRC (37H 42H)	Delimiter (0DH 0AH)
1	2	2	4	4	2	2

- Response message from the slave in normal status [1.00 MΩ·cm (0064H)]

The response byte count means the byte count of the data which has been read.

It is fixed as (30H 32H).

Header (3AH)	Slave Address (30H 31H)	Function Code (30H 33H)	Response Byte Count [02H] (30H 32H)	Data [0064H] (30H 30H 36H 34H)	Error Check LRC (39H 36H)	Delimiter (0DH 0AH)
1	2	2	2	4	2	2

- Response message from the slave in exception (error) status (When a data item is incorrect)
The function code MSB is set to 1 for the response message in exception (error) status (83H).
The exception code 02H (Non-existent data address) is returned (error).

Header (3AH)	Slave Address (30H 31H)	Function Code (38H 33H)	Exception Code [02H] (30H 32H)	Error Check LRC (37H 41H)	Delimiter (0DH 0AH)
1	2	2	2	2	2

② Setting [Slave address 1, Data item 0006H (A11 value)]

- A request message from the master [When A11 value is set to 1.00 (0064H)]

Header (3AH)	Slave Address (30H 31H)	Function Code (30H 36H)	Data Item [0006H] (30H 30H 30H 36H)	Data [0064H] (30H 30H 36H 34H)	Error Check LRC (38H 44H)	Delimiter (0DH 0AH)
1	2	2	4	4	2	2

- Response message from the slave in normal status

Header (3AH)	Slave Address (30H 31H)	Function Code (30H 36H)	Data Item [0006H] (30H 30H 30H 36H)	Data [0064H] (30H 30H 36H 34H)	Error Check LRC (38H 44H)	Delimiter (0DH 0AH)
1	2	2	4	4	2	2

- Response message from the slave in exception (error) status (When a value out of the setting range is set)

The function code MSB is set to 1 for the response message in exception (error) status (86H).

The exception code 03H (Value out of the setting range) is returned (error).

Header (3AH)	Slave Address (30H 31H)	Function Code (38H 36H)	Exception Code [03H] (30H 33H)	Error Check LRC (37H 36H)	Delimiter (0DH 0AH)
1	2	2	2	2	2

RTU Mode

Numerals written below the command represent the number of characters.

① Reading [Slave address 1, Data item 0080H (Resistivity)]

- A request message from the master

Amount of data means how many data items are to be read. It is fixed as (0001H).

3.5 Idle Characters	Slave Address (01H)	Function Code (03H)	Data Item (0080H)	Amount of Data (0001H)	Error Check CRC-16 (85E2H)	3.5 idle characters
	1	1	2	2	2	

- Response message from the slave in normal status [1.00 MΩ·cm (0064H)]

The response byte count means the byte count of the data which has been read.

It is fixed as (02H).

3.5 Idle Characters	Slave Address (01H)	Function Code (03H)	Response Byte Count (02H)	Data (0064H)	Error Check CRC-16 (B9AFH)	3.5 idle characters
	1	1	1	2	2	

- Response message from the slave in exception (error) status (When data item is incorrect).

The function code MSB is set to 1 for the response message in exception (error) status (83H).

The exception code (02H: Non-existent data address) is returned (error).

3.5 Idle Characters	Slave Address (01H)	Function Code (83H)	Exception Code (02H)	Error Check CRC-16 (C0F1H)	3.5 idle characters
	1	1	1	2	

② Setting [Slave address 1, Data item 0006H (A11 value)]

- A request message from the master [When A11 value is set to 1.00 (0064H)]

3.5 Idle Characters	Slave Address (01H)	Function Code (06H)	Data Item (0006H)	Data (0064H)	Error Check CRC-16 (6820H)	3.5 idle characters
	1	1	2	2	2	

- Response message from the slave in normal status

3.5 Idle Characters	Slave Address (01H)	Function Code (06H)	Data Item (0006H)	Data (0064H)	Error Check CRC-16 (6820H)	3.5 idle characters
	1	1	2	2	2	

- Response message from the slave in exception (error) status (When a value out of the setting range is set)

The function code MSB is set to 1 for the response message in exception (error) status (86H).

The exception code (03H: Value out of the setting range) is returned (error).

3.5 Idle Characters	Slave Address (01H)	Function Code (86H)	Exception Code (03H)	Error Check CRC-16 (0261H)	3.5 idle characters
	1	1	1	2	

11.6 Communication Command Table

11.6.1 Notes about Setting/Reading Command

- The data (set value, decimal) is converted to hexadecimal numbers.
A negative number is represented in 2's complement.
- When connecting multiple slaves, the address (instrument number) must not be duplicated.
- Data item 0200H to 0209H (User save area 1 to 10) can be read or set in 1 word units.
Effective range of data is -32768 to 32767 (8000H to 7FFFH).
- MODBUS protocol uses Holding Register addresses. The Holding Register addresses are created as follows. A Shinko command data item is converted to decimal number, and the offset of 40001 is added. The result is the Holding Register address.
Using Data item 0001H (Sensor cell constant) as an example:
Data item in the sending message is 0001H, however, MODBUS protocol Holding Register address is 40002 (1 + 40001).
- Even if options are not ordered, setting or reading via software communication will be possible. A11, A12, A21 and A22 command contents will function. However, Transmission output 1 and 2 command contents will not function.

(1) Setting Command

- Up to 1,000,000 (one million) entries can be stored in non-volatile IC memory.
If the number of settings exceeds the limit, the data will not be saved. So, ensure the set values are not frequently changed via software communication. (If a value set via software communication is the same as the value before the setting, the value will not be written in non-volatile IC memory.)
- Be sure to select Lock 3 when changing the set value frequently via software communication.
If Lock 3 is selected, all set values – except Measurement unit, Measurement range, Resistivity calibration value, Temperature calibration value, Transmission output 1 Zero and Span adjustment values, Transmission output 2 Zero and Span adjustment values – can be temporarily changed.
However, they revert to their previous value after the power is turned off because they are not saved in the non-volatile IC memory. Do not change setting items (A11, A12, A21 and A22 types). If they are changed, they will affect other setting items.
- Setting range of each item (via the communication function) is the same as when setting via the keypad.
- When the data (set value) has a decimal point, a whole number (hexadecimal) without a decimal point is used.
- If A11, A12, A21 or A22 type is changed in [A11, A12, A21 or A22 type] (A11: 0005H, A12: 0050H, A21: 0051H, A22: 0052H), the A11, A12, A21 or A22 value (A11: 0006H, A12: 0053H, A21: 0054H, A22: 0055H) will default to “0.00” or “0.0”. Output status of A11, A12, A21 or A22 will also be initialized.
- Settings via software communication are possible while in Set value lock status.
- Communication parameters such as Instrument Number, Communication Speed of the slave cannot be set by software communication. They can only be set via the keypad.
- When sending a command by Global address [95 (7FH), Shinko protocol] or Broadcast address [00H, MODBUS protocol], the same command is sent to all the slaves connected. However, the response is not returned.

(2) Reading Command

- When the data (set value) has a decimal point, a whole number (hexadecimal) without a decimal point is used for a response.

11.6.2 Setting/Reading Command

Shinko Command Type	MODBUS Function Code	Data Item		Data
20H	03H	0001H	Sensor cell constant	Fixed at 0.01.
50H/20H	06H/03H	0002H	Cell constant correction value	Set value
50H/20H	06H/03H	0003H	Measurement unit	0000H: Resistivity ($M\Omega\cdot cm$) 0001H: Resistivity ($k\Omega\cdot m$)
50H/20H	06H/03H	0004H	Measurement range	When Resistivity ($M\Omega\cdot cm$) is selected in [Measurement unit]: 0000H: 0.000 to 0.200 $M\Omega\cdot cm$ 0001H: 0.00 to 2.00 $M\Omega\cdot cm$ 0002H: 0.00 to 20.00 $M\Omega\cdot cm$ 0003H: 0.0 to 100.0 $M\Omega\cdot cm$ When Resistivity ($k\Omega\cdot m$) is selected in [Measurement unit]: 0000H: 0.00 to 2.00 $k\Omega\cdot m$ 0001H: 0.0 to 20.0 $k\Omega\cdot m$ 0002H: 0.0 to 200.0 $k\Omega\cdot m$ 0003H: 0 to 1000 $k\Omega\cdot m$
50H/20H	06H/03H	0005H	A11 type	0000H: No action 0001H: Resistivity input low limit action 0002H: Resistivity input high limit action 0003H: Temperature input low limit action 0004H: Temperature input high limit action 0005H: Error output 0006H: Fail output 0007H: Resistivity input High/Low limits independent action 0008H: Temperature input High/Low limits independent action
50H/20H	06H/03H	0006H	A11 value	Set value
50H/20H	06H/03H	0007H	A11 ON side	Set value
50H/20H	06H/03H	0008H	A11 ON delay time	Set value
50H/20H	06H/03H	0009H	A11 OFF delay time	Set value
50H/20H	06H/03H	000AH	Resistivity input filter time constant	Set value
50H/20H	06H/03H	000CH	Ultrapure water value	When Resistivity ($M\Omega\cdot cm$) is selected in [Measurement unit]: 0000H: 18.18 $M\Omega\cdot cm$ 0001H: 18.23 $M\Omega\cdot cm$ 0002H: 18.24 $M\Omega\cdot cm$ When Resistivity ($k\Omega\cdot m$) is selected in [Measurement unit]: 0000H: 181.8 $k\Omega\cdot m$ 0001H: 182.3 $k\Omega\cdot m$ 0002H: 182.4 $k\Omega\cdot m$
50H/20H	06H/03H	000DH	Clip value	Set value
50H/20H	06H/03H	0020H	Temperature compensation method	0000H: Temperature characteristics of deionized water 0001H: Temperature characteristics of deionized water and impure substances 0002H: Temperature coefficient ($\%/^{\circ}C$) and randomly selected reference temperature 0003H: No temperature compensation

Shinko Command Type	MODBUS Function Code	Data Item		Data															
50H/20H	06H/03H	0021H	Temperature coefficient	Set value															
50H/20H	06H/03H	0022H	Reference temperature	Set value															
50H/20H	06H/03H	0023H	Temperature input decimal point place	0000H: No decimal point 0001H: 1 digit after decimal point															
50H/20H	06H/03H	0029H	Temperature input filter time constant	Set value															
50H/20H	06H/03H	0030H	Set value lock	0000H: Unlock 0001H: Lock 1 0002H: Lock 2 0003H: Lock 3															
50H/20H	06H/03H	0031H	Transmission output 1 type	0000H: Resistivity transmission 0001H: Temperature transmission															
50H/20H	06H/03H	0032H	Transmission output 1 high limit	Set value															
50H/20H	06H/03H	0033H	Transmission output 1 low limit	Set value															
50H/20H	06H/03H	0034H	Auto-light function	0000H: Disabled 0001H: Enabled															
50H/20H	06H/03H	0035H	Display selection	<table border="1"> <thead> <tr> <th>Data</th> <th>Resistivity Display (CH1)</th> <th>Temperature Display (CH2)</th> </tr> </thead> <tbody> <tr> <td>0000H</td> <td>Resistivity</td> <td>Temperature</td> </tr> <tr> <td>0001H</td> <td>Resistivity</td> <td>No indication</td> </tr> <tr> <td>0002H</td> <td>No indication</td> <td>Temperature</td> </tr> <tr> <td>0003H</td> <td>No indication</td> <td>No indication</td> </tr> </tbody> </table>	Data	Resistivity Display (CH1)	Temperature Display (CH2)	0000H	Resistivity	Temperature	0001H	Resistivity	No indication	0002H	No indication	Temperature	0003H	No indication	No indication
Data	Resistivity Display (CH1)	Temperature Display (CH2)																	
0000H	Resistivity	Temperature																	
0001H	Resistivity	No indication																	
0002H	No indication	Temperature																	
0003H	No indication	No indication																	
50H/20H	06H/03H	0036H	Indication time	Set value															
50H	06H	0040H	Temperature calibration mode	0000H: Resistivity/Temperature Display Mode 0001H: Temperature calibration mode															
50H/20H	06H/03H	0041H	Temperature calibration value	Set value															
50H	06H	0042H	Resistivity Calibration Span Adjustment mode	0000H: Resistivity/Temperature Display Mode 0001H: Resistivity Calibration Span Adjustment mode															
50H/20H	06H/03H	0044H	Resistivity Span adjustment value	Set value															
50H/20H	06H/03H	0045H	A□□ output when input errors occur	0000H: Enabled 0001H: Disabled															
50H/20H	06H/03H	0046H	Cable length correction	Set value															
50H/20H	06H/03H	0047H	Cable cross-section area	Set value															
50H/20H	06H/03H	0048H	Output ON time when A1 output is ON	Set value															
50H/20H	06H/03H	0049H	Output OFF time when A1 output is ON	Set value															
50H/20H	06H/03H	004AH	Output ON time when A2 output is ON	Set value															
50H/20H	06H/03H	004BH	Output OFF time when A2 output is ON	Set value															

Shinko Command Type	MODBUS Function Code	Data Item		Data
50H/20H	06H/03H	0050H	A12 type	0000H: No action 0001H: Resistivity input low limit action 0002H: Resistivity input high limit action 0003H: Temperature input low limit action 0004H: Temperature input high limit action 0005H: Error output 0006H: Fail output 0007H: Resistivity input High/Low limits independent action 0008H: Temperature input High/Low limits independent action
50H/20H	06H/03H	0051H	A21 type	0000H: No action 0001H: Resistivity input low limit action 0002H: Resistivity input high limit action 0003H: Temperature input low limit action 0004H: Temperature input high limit action 0005H: Error output 0006H: Fail output 0007H: Resistivity input High/Low limits independent action 0008H: Temperature input High/Low limits independent action
50H/20H	06H/03H	0052H	A22 type	0000H: No action 0001H: Resistivity input low limit action 0002H: Resistivity input high limit action 0003H: Temperature input low limit action 0004H: Temperature input high limit action 0005H: Error output 0006H: Fail output 0007H: Resistivity input High/Low limits independent action 0008H: Temperature input High/Low limits independent action
50H/20H	06H/03H	0053H	A12 value	Set value
50H/20H	06H/03H	0054H	A21 value	Set value
50H/20H	06H/03H	0055H	A22 value	Set value
50H/20H	06H/03H	0056H	A12 ON side	Set value
50H/20H	06H/03H	0057H	A21 ON side	Set value
50H/20H	06H/03H	0058H	A22 ON side	Set value
50H/20H	06H/03H	0059H	A12 ON delay time	Set value
50H/20H	06H/03H	005AH	A21 ON delay time	Set value
50H/20H	06H/03H	005BH	A22 ON delay time	Set value
50H/20H	06H/03H	005CH	A12 OFF delay time	Set value
50H/20H	06H/03H	005DH	A21 OFF delay time	Set value
50H/20H	06H/03H	005EH	A22 OFF delay time	Set value
50H/20H	06H/03H	0068H	Resistivity input sensor correction	Set value
50H/20H	06H/03H	0069H	Temperature Display when no temperature compensation	0000H: Unlit 0001H: Reference temperature 0002H: Measured value

Shinko Command Type	MODBUS Function Code	Data Item		Data
50H/20H	06H/03H	006AH	A1 output allocation	0000H: A11 type 0001H: A12 type 0002H: A21 type 0003H: A22 type 0004H: A11, A12 types 0005H: A21, A22 types 0006H: A11, A21 types 0007H: A12, A22 types 0008H: A11, A12, A21, A22 types
50H/20H	06H/03H	006BH	A2 output allocation	0000H: A11 type 0001H: A12 type 0002H: A21 type 0003H: A22 type 0004H: A11, A12 types 0005H: A21, A22 types 0006H: A11, A21 types 0007H: A12, A22 types 0008H: A11, A12, A21, A22 types
50H/20H	06H/03H	006FH	Pt100 input wire type	0000H: 2-wire type 0001H: 3-wire type
50H	06H	007FH	Key operation change flag clearing	0001H: Clear change flag
50H/20H	06H/03H	0100H	A11 hysteresis type	0000H: Medium Value 0001H: Reference Value
50H/20H	06H/03H	0101H	A12 hysteresis type	0000H: Medium Value 0001H: Reference Value
50H/20H	06H/03H	0102H	A21 hysteresis type	0000H: Medium Value 0001H: Reference Value
50H/20H	06H/03H	0103H	A22 hysteresis type	0000H: Medium Value 0001H: Reference Value
50H/20H	06H/03H	0104H	A11 OFF side	Set value
50H/20H	06H/03H	0105H	A12 OFF side	Set value
50H/20H	06H/03H	0106H	A21 OFF side	Set value
50H/20H	06H/03H	0107H	A22 OFF side	Set value
50H/20H	06H/03H	010FH	Transmission output 1 status when calibrating	0000H: Last value HOLD 0001H: Set value HOLD 0002H: Measured value
50H/20H	06H/03H	0110H	Transmission output 1 value HOLD when calibrating	Set value
50H/20H	06H/03H	0111H	A1 resistivity input error alarm A□□ type	0000H: No action 0001H: A11 type 0002H: A12 type 0003H: A21 type 0004H: A22 type
50H/20H	06H/03H	0112H	A2 resistivity input error alarm A□□ type	0000H: No action 0001H: A11 type 0002H: A12 type 0003H: A21 type 0004H: A22 type

Shinko Command Type	MODBUS Function Code	Data Item		Data
50H/20H	06H/03H	0115H	A1 resistivity input error alarm band when A□□ output ON	Set value
50H/20H	06H/03H	0116H	A1 resistivity input error alarm time when A□□ output ON	Set value
50H/20H	06H/03H	0117H	A1 resistivity input error alarm band when A□□ output OFF	Set value
50H/20H	06H/03H	0118H	A1 resistivity input error alarm time when A□□ output OFF	Set value
50H/20H	06H/03H	0119H	A2 resistivity input error alarm band when A□□ output ON	Set value
50H/20H	06H/03H	011AH	A2 resistivity input error alarm time when A□□ output ON	Set value
50H/20H	06H/03H	011BH	A2 resistivity input error alarm band when A□□ output OFF	Set value
50H/20H	06H/03H	011CH	A2 resistivity input error alarm time when A□□ output OFF	Set value
50H/20H	06H/03H	0125H	Resistivity input error alarm time unit	0000H: Second(s) 0001H: Minute(s)
50H	06H	0126H	Transmission output 1 adjustment mode	0000H: Resistivity/Temperature Display Mode 0001H: Transmission output 1 Zero adjustment mode 0002H: Transmission output 1 Span adjustment mode
50H/20H	06H/03H	0127H	Transmission output 1 Zero adjustment value	Set value
50H/20H	06H/03H	0128H	Transmission output 1 Span adjustment value	Set value
50H/20H	06H/03H	0139H	A11 High/Low limits independent lower side span	Set value
50H/20H	06H/03H	013AH	A12 High/Low limits independent lower side span	Set value
50H/20H	06H/03H	013BH	A21 High/Low limits independent lower side span	Set value
50H/20H	06H/03H	013CH	A22 High/Low limits independent lower side span	Set value
50H/20H	06H/03H	013DH	A11 High/Low limits independent upper side span	Set value
50H/20H	06H/03H	013EH	A12 High/Low limits independent upper side span	Set value
50H/20H	06H/03H	013FH	A21 High/Low limits independent upper side span	Set value
50H/20H	06H/03H	0140H	A22 High/Low limits independent upper side span	Set value

Shinko Command Type	MODBUS Function Code	Data Item		Data
50H/20H	06H/03H	0141H	A11 hysteresis	Set value
50H/20H	06H/03H	0142H	A12 hysteresis	Set value
50H/20H	06H/03H	0143H	A21 hysteresis	Set value
50H/20H	06H/03H	0144H	A22 hysteresis	Set value
50H/20H	06H/03H	0147H	Transmission output 2 type	0000H: Resistivity transmission 0001H: Temperature transmission
50H/20H	06H/03H	0148H	Transmission output 2 high limit	Set value
50H/20H	06H/03H	0149H	Transmission output 2 low limit	Set value
50H	06H	014AH	Transmission output 2 adjustment mode (*)	0000H: Resistivity/Temperature Display Mode 0001H: Transmission output 2 Zero adjustment mode 0002H: Transmission output 2 Span adjustment mode
50H/20H	06H/03H	014BH	Transmission output 2 Zero adjustment value	Set value
50H/20H	06H/03H	014CH	Transmission output 2 Span adjustment value	Set value
50H/20H	06H/03H	014DH	Transmission output 2 status when calibrating	0000H: Last value HOLD 0001H: Set value HOLD 0002H: Measured value
50H/20H	06H/03H	014EH	Transmission output 2 value HOLD when calibrating	Set value
50H/20H	06H/03H	0151H	Resistivity inputs for moving average	Set value
50H/20H	06H/03H	0152H	Temperature inputs for moving average	Set value
50H/20H	06H/03H	0153H	Measurement range cut function	0000H: Disabled 0001H: Enabled
50H/20H	06H/03H	0200H	User save area 1	-32768 to 32767 (8000H to 7FFFH)
50H/20H	06H/03H	0201H	User save area 2	-32768 to 32767 (8000H to 7FFFH)
50H/20H	06H/03H	0202H	User save area 3	-32768 to 32767 (8000H to 7FFFH)
50H/20H	06H/03H	0203H	User save area 4	-32768 to 32767 (8000H to 7FFFH)
50H/20H	06H/03H	0204H	User save area 5	-32768 to 32767 (8000H to 7FFFH)
50H/20H	06H/03H	0205H	User save area 6	-32768 to 32767 (8000H to 7FFFH)
50H/20H	06H/03H	0206H	User save area 7	-32768 to 32767 (8000H to 7FFFH)
50H/20H	06H/03H	0207H	User save area 8	-32768 to 32767 (8000H to 7FFFH)
50H/20H	06H/03H	0208H	User save area 9	-32768 to 32767 (8000H to 7FFFH)
50H/20H	06H/03H	0209H	User save area 10	-32768 to 32767 (8000H to 7FFFH)

(*) If 'Setting' is executed while Transmission output 2 (TA2 option) is not ordered, the following error code will be returned.

- Shinko protocol: Error code 3 (33H)
- MODBUS: Exception code 3 (03H)

11.6.3 Read Only Command

Shinko Command Type	MODBUS Function Code	Data Item	Data									
20H	03H	0080H	Resistivity									
20H	03H	0081H	<p>Status flag 1 0000 0000 0000 0000 2^{15} to 2^0</p> <p>2^0 digit: Temperature sensor burnout 0: Normal 1: Burnout</p> <p>2^1 digit: Temperature sensor short-circuited 0: Normal 1: Short-circuited</p> <p>2^2 digit: Outside temperature compensation range: Exceeding 110.0°C 0: Normal 1: Exceeding 110.0°C</p> <p>2^3 digit: Outside temperature compensation range: Less than 0.0°C 0: Normal 1: Less than 0.0°C</p> <p>2^4 digit: Resistivity measured value is outside the measurement range (high limit) 0: Normal 1: Outside high limit</p> <p>2^5 digit: Resistivity measured value is outside the measurement range (low limit) 0: Normal 1: Outside low limit</p> <p>2^6 digit: A11 output flag 0: OFF 1: ON</p> <p>2^7 digit: A12 output flag 0: OFF 1: ON</p> <p>2^8 digit: A21 output flag 0: OFF 1: ON</p> <p>2^9 digit: A22 output flag 0: OFF 1: ON</p> <p>2^{10} digit: Not used (Always 0)</p> <p>2^{11} digit: Unit status flag 0: Resistivity/Temperature Display Mode 1: Setting mode</p> <p>$2^{12}, 2^{13}$ digits: Resistivity calibration Span adjustment status flag</p> <table border="1" style="margin-left: 40px;"> <thead> <tr> <th>2^{13}</th> <th>2^{12}</th> <th>Status</th> </tr> </thead> <tbody> <tr> <td>0</td> <td>0</td> <td>Resistivity/Temperature Display Mode</td> </tr> <tr> <td>0</td> <td>1</td> <td>During Resistivity calibration Span adjustment mode</td> </tr> </tbody> </table> <p>2^{14} digit: A1 output 0: OFF 1: ON</p> <p>2^{15} digit: Change in key operation 0: No 1: Yes</p>	2^{13}	2^{12}	Status	0	0	Resistivity/Temperature Display Mode	0	1	During Resistivity calibration Span adjustment mode
2^{13}	2^{12}	Status										
0	0	Resistivity/Temperature Display Mode										
0	1	During Resistivity calibration Span adjustment mode										
20H	03H	0090H	Temperature									

Shinko Command Type	MODBUS Function Code	Data Item	Data																																	
20H	03H	0091H	<p>Status flag 2 0000 0000 0000 0000 2^{15} to 2^0 2^0 digit: Not used (Always 0) 2^1 digit: A2 output 0: OFF 1: ON $2^2, 2^3$ digits: Not used (Always 0) $2^4, 2^5$ digits: Transmission output 1 adjustment status flag</p> <table border="1"> <thead> <tr> <th>2^5</th> <th>2^4</th> <th>Status</th> </tr> </thead> <tbody> <tr> <td>0</td> <td>0</td> <td>Resistivity/Temperature Display Mode</td> </tr> <tr> <td>0</td> <td>1</td> <td>During Transmission output 1 Zero adjustment in Transmission output 1 adjustment mode</td> </tr> <tr> <td>1</td> <td>0</td> <td>During Transmission output 1 Span adjustment in Transmission output 1 adjustment mode</td> </tr> </tbody> </table> <p>2^6 digit: A1 resistivity input error alarm output flag 0: OFF 1: ON 2^7 digit: A2 resistivity input error alarm output flag 0: OFF 1: ON $2^8, 2^9$ digits: Transmission output 2 adjustment status flag</p> <table border="1"> <thead> <tr> <th>2^9</th> <th>2^8</th> <th>Status</th> </tr> </thead> <tbody> <tr> <td>0</td> <td>0</td> <td>Resistivity/Temperature Display Mode</td> </tr> <tr> <td>0</td> <td>1</td> <td>During Transmission output 2 Zero adjustment in Transmission output 2 adjustment mode</td> </tr> <tr> <td>1</td> <td>0</td> <td>During Transmission output 2 Span adjustment in Transmission output 2 adjustment mode</td> </tr> </tbody> </table> <p>$2^{10}, 2^{11}$ digits: Not used (Always 0) $2^{12}, 2^{13}$ digits: Temperature calibration status flag</p> <table border="1"> <thead> <tr> <th>2^{13}</th> <th>2^{12}</th> <th>Status</th> </tr> </thead> <tbody> <tr> <td>0</td> <td>0</td> <td>Resistivity/Temperature Display Mode</td> </tr> <tr> <td>0</td> <td>1</td> <td>During temperature calibration</td> </tr> </tbody> </table> <p>$2^{14}, 2^{15}$ digits: Not used (Always 0)</p>	2^5	2^4	Status	0	0	Resistivity/Temperature Display Mode	0	1	During Transmission output 1 Zero adjustment in Transmission output 1 adjustment mode	1	0	During Transmission output 1 Span adjustment in Transmission output 1 adjustment mode	2^9	2^8	Status	0	0	Resistivity/Temperature Display Mode	0	1	During Transmission output 2 Zero adjustment in Transmission output 2 adjustment mode	1	0	During Transmission output 2 Span adjustment in Transmission output 2 adjustment mode	2^{13}	2^{12}	Status	0	0	Resistivity/Temperature Display Mode	0	1	During temperature calibration
2^5	2^4	Status																																		
0	0	Resistivity/Temperature Display Mode																																		
0	1	During Transmission output 1 Zero adjustment in Transmission output 1 adjustment mode																																		
1	0	During Transmission output 1 Span adjustment in Transmission output 1 adjustment mode																																		
2^9	2^8	Status																																		
0	0	Resistivity/Temperature Display Mode																																		
0	1	During Transmission output 2 Zero adjustment in Transmission output 2 adjustment mode																																		
1	0	During Transmission output 2 Span adjustment in Transmission output 2 adjustment mode																																		
2^{13}	2^{12}	Status																																		
0	0	Resistivity/Temperature Display Mode																																		
0	1	During temperature calibration																																		

11.7 Resistivity Calibration Span Adjustment and Temperature Calibration, Transmission Output 1 and 2 Adjustments via Communication Command

11.7.1 Resistivity Calibration Span Adjustment

Cell constant may vary due to deterioration of the 2-electrode Resistivity Sensor.

To correct the varied cell constant, calibration must be performed.

Adjust the correction value so that the resistivity input value matches the reference resistivity meter.

The following outlines the procedure for Resistivity Calibration Span Adjustment.

- ① Set Data item 0042H (Resistivity Calibration Span Adjustment mode) to 0001H.
The unit proceeds to Resistivity Calibration Span Adjustment mode.
- ② Set the Resistivity Span adjustment value at Data item 0044H (Resistivity Span adjustment value), while checking the reference resistivity meter.
- ③ If 2^{13} and 2^{12} digits are read at Data item 0081H (Status flag 1), 01 (During Resistivity Calibration Span Adjustment mode) will be returned.
- ④ Set Data item 0042H (Resistivity Calibration Span Adjustment mode) to 0000H.
Resistivity Calibration Span Adjustment will be complete, and the unit will revert to Resistivity/Temperature Display Mode.

During Resistivity Calibration Span Adjustment, if Resistivity calibration Span adjustment cannot be performed due to reasons such as temperature compensation error, and if 2^0 digit to 2^3 digit are read at Data item 0081H (Status flag 1), Error code 1 (Burnout, Short-circuited, Exceeding 110.0°C , Less than 0.0°C) will be returned.

To release the error code, set Data item 0042H (Resistivity Calibration Span Adjustment mode) to 0000H.

The unit reverts to Resistivity/Temperature Display Mode.

In Resistivity/Temperature Display Mode, if Resistivity Span adjustment value is set at Data item 0044H (Resistivity Span adjustment value), the following error codes will be returned.

- Shinko protocol: Error code 34H
- MODBUS protocol: Exception code 11H

11.7.2 Temperature Calibration

Temperature calibration is performed by setting temperature calibration value.

The following outlines the procedure for Temperature calibration.

- ① Set Data item 0040H (Temperature calibration mode) to 0001H.
The unit will proceed to Temperature calibration mode.
If 2^{13} and 2^{12} digits are read at Data item 0091H (Status flag 2), 01 (During temperature calibration) will be returned.
- ② Set the temperature calibration value at Data item 0041H (Temperature calibration value), while checking the temperature.
- ③ Set Data item 0040H (Temperature calibration mode) to 0000H.
Temperature calibration will be complete, and the unit will revert to Resistivity/Temperature Display Mode.

During temperature calibration, if temperature calibration cannot be performed due to reasons such as input error, calibration value error, and if 2^0 digit to 2^3 digit are read at Data item 0081H (Status flag 1), Error code 1 (Burnout, Short-circuited, Exceeding 110.0°C , Less than 0.0°C) will be returned.

To release the error code, set Data item 0040H (Temperature calibration mode) to 0000H.

The unit reverts to Resistivity/Temperature Display Mode.

In Resistivity/Temperature Display Mode, if temperature calibration value is set at Data item 0041H (Temperature calibration value), the following error codes will be returned.

- Shinko protocol: Error code 34H
- MODBUS protocol: Exception code 11H

11.7.3 Transmission Output 1 Adjustment

Fine adjustment of Transmission output 1 is performed.

This instrument is adjusted at the factory, however, differences may occur between the indication value of the connected equipment (recorders, etc.) and output value of this instrument.

In this case, perform Transmission output 1 Zero and Span adjustments.

The following outlines the procedure for Transmission output 1 adjustment.

- ① Set Data item 0126H (Transmission output 1 adjustment mode) to 0001H.
The unit moves to Transmission output 1 Zero adjustment mode.
If 2⁵, 2⁴ digits are read at Data item 0091H (Status flag 2), 01 (During Transmission output 1 Zero adjustment in Transmission output 1 adjustment mode) will be returned.
- ② Set the Transmission output 1 Zero adjustment value at Data item 0127H (Transmission output 1 Zero adjustment value), while viewing the value indicated on the connected equipment (recorders, etc.).
Setting range: $\pm 5.00\%$ of Transmission output 1 span
- ③ Set Data item 0126H (Transmission output 1 adjustment mode) to 0002H.
The unit moves to Transmission output 1 Span adjustment mode.
If 2⁵, 2⁴ digits are read at Data item 0091H (Status flag 2), 10 (During Transmission output 1 Span adjustment in Transmission output 1 adjustment mode) will be returned.
- ④ Set Transmission output 1 Span adjustment value at Data item 0128H (Transmission output 1 Span adjustment value), while viewing the value indicated on the connected equipment (recorders, etc.).
Setting range: $\pm 5.00\%$ of Transmission output 1 span
- ⑤ Repeat steps ① to ④ if necessary.
- ⑥ To finish Transmission output 1 adjustment, set Data item 0126H (Transmission output 1 adjustment mode) to 0000H.
The unit reverts to Resistivity/Temperature Display Mode.

11.7.4 Transmission Output 2 Adjustment

Fine adjustment of Transmission output 2 is performed.

This instrument is adjusted at the factory, however, differences may occur between the indication value of the connected equipment (recorders, etc.) and output value of this instrument.

In this case, perform Transmission output 2 Zero and Span adjustments.

The following outlines the procedure for Transmission output 2 adjustment.

- ① Set Data item 014AH (Transmission output 2 adjustment mode) to 0001H.
The unit moves to Transmission output 2 Zero adjustment mode.
If 2⁹, 2⁸ digits are read at Data item 0091H (Status flag 2), 01 (During Transmission output 2 Zero adjustment in Transmission output 2 adjustment mode) will be returned.
- ② Set the Transmission output 2 Zero adjustment value at Data item 014BH (Transmission output 2 Zero adjustment value), while viewing the value indicated on the connected equipment (recorders, etc.).
Setting range: $\pm 5.00\%$ of Transmission output 2 span
- ③ Set Data item 014AH (Transmission output 2 adjustment mode) to 0002H.
The unit moves to Transmission output 2 Span adjustment mode.
If 2⁹, 2⁸ digits are read at Data item 0091H (Status flag 2), 10 (During Transmission output 2 Span adjustment in Transmission output 2 adjustment mode) will be returned.
- ④ Set Transmission output 2 Span adjustment value at Data item 014CH (Transmission output 2 Span adjustment value), while viewing the value indicated on the connected equipment (recorders, etc.).
Setting range: $\pm 5.00\%$ of Transmission output 2 span
- ⑤ Repeat steps ① to ④ if necessary.
- ⑥ To finish Transmission output 2 adjustment, set Data item 014AH (Transmission output 2 adjustment mode) to 0000H.
The unit reverts to Resistivity/Temperature Display Mode.

11.8 Notes on Programming Monitoring Software

11.8.1 How to Speed up the Scan Time

When monitoring multiple units of the WIL-102-SE, set the program so that the requisite minimum pieces of data such as Data item 0080H (Resistivity), Data item 0090H (Temperature), Data item 0081H (Status flag 1), Data item 0091H (Status flag 2) can be read. For other data, set the program so that they can be read only when their set value has been changed. This will speed up the scan time.

11.8.2 How to Read the Set Value Changes Made by Front Keypad Operation

If any set value is changed by keypad operation, WIL-102-SE will set [0081H (Status flag 1) 2¹⁵: Change in key operation] to 1 (Yes).

There are 2 methods of reading the set value changes made by the front keypad:

(1) Reading Method 1

- ① On the monitoring software side, check that [0081H (Status flag 1) 2¹⁵: Change in key operation] has been set to 1 (Yes), then read all set values.
- ② Clear [0081H (Status flag 1) 2¹⁵: Change in key operation], by setting Data item 007FH (Key operation change flag clearing) to 0001H (Clear change flag).

If 007FH (Key operation change flag clearing) is set to 0001H (Clear change flag) during setting mode of the instrument, Error code 5 (35H, Shinko protocol) or Exception Code 18 (12H, MODBUS protocol) will be returned as a negative acknowledgement. And [0081H (Status flag 1) 2¹⁵: Change in key operation] cannot be cleared.

Set a program so that all set values can be read when a negative acknowledgement is returned.

- ③ Read all set values again after acknowledgement is returned.

(2) Reading Method 2

- ① On the monitoring software side, check that [0081H (Status flag 1) 2¹⁵: Change in key operation] has been set to 1 (Yes), then set 007FH (Key operation change flag clearing) to 0001H (Clear change flag).
- ② Set the program depending on the acknowledgement or negative acknowledgement as follows.

When acknowledgement is returned:

Consider it as settings completed, and read all set values.

When Error code 5 (35H, Shinko protocol) or Exception code 18 (12H, MODBUS protocol) is returned as a negative acknowledgement:

Consider it as still in setting mode, and read the requisite minimum pieces of data such as 0080H (Resistivity), 0090H (Temperature), 0081H (Status flag 1), 0091H (Status flag 2), then return to step ①.

Thus, programs which do not affect the scan time can be created using the methods described above, even if set values on the monitoring software will not be updated until settings are complete.

11.8.3 Note when Sending All Set Values Simultaneously

- When A11, A12, A21 or A22 type is changed at Data item 0005H (A11 type), 0050H (A12 type), 0051H (A21 type) or 0052H (A22 type), the A11, A12, A21 or A22 value will default to "0.00" or "0.0". Output status of A11, A12, A21 or A22 will also be initialized.

First, send the A11, A12, A21, A22 type, then send the A11, A12, A21, A22 value at Data item 0006H (A11 value), 0053H (A12 value), 0054H (A21 value) or 0055H (A22 value).

12. Specifications

12.1 Standard Specifications

Rating

Rated Scale	Input		Input Range	Resolution
	Resistivity	Cell constant 0.01/cm		0.000 to 0.200 MΩ•cm
			0.00 to 2.00 MΩ•cm	0.01 MΩ•cm
			0.00 to 20.00 MΩ•cm	0.01 MΩ•cm
			0.0 to 100.0 MΩ•cm	0.1 MΩ•cm
			0.00 to 2.00 kΩ•m	0.01 kΩ•m
			0.0 to 20.0 kΩ•m	0.1 kΩ•m
			0.0 to 200.0 kΩ•m	0.1 kΩ•m
			0 to 1000 kΩ•m	1 kΩ•m
Temperature	Pt100		0.0 to 100.0°C	0.1°C
	Pt1000		0.0 to 100.0°C	0.1°C
For the Temperature indication, decimal point place is selectable.				
Input	2-electrode Resistivity Sensor (Temperature element: Pt100) 2-electrode Resistivity Sensor (Temperature element: Pt1000)			
Power Supply Voltage	Model	WIL-102-SE		WIL-102-SE 1
	Power supply voltage	100 to 240 V AC 50/60 Hz		24 V AC/DC 50/60 Hz
	Allowable voltage fluctuation range	85 to 264 V AC		20 to 28 V AC/DC

General Structure

External Dimensions	30 x 88 x 108 mm (W x H x D, including socket)		
Mounting	DIN rail		
Case	Material: Flame-resistant resin, Color: Light gray		
Front Panel	Membrane sheet		
Indication Structure	Display		
	Resistivity Display	Red LED 4-digits, character size 10 x 4.6 mm (H x W)	
	Temperature Display	Red LED 4-digits, character size 10 x 4.6 mm (H x W)	
	Action indicators		
	PWR (Yellow)	Lights when power to the instrument is turned ON.	
	A1 (Red)	Lights when A1 output is ON. (Unlit if TA2 option is ordered.)	
	A2 (Yellow)	Lights when A2 output is ON. (Unlit if TA or TA2 option is ordered.)	
	T/R (Yellow)	Lights while in Serial communication TX output (transmitting).	
	Setting Structure	Setting method: Input system using membrane sheet key.	

Indication Performance

Repeatability	Resistivity: $\pm 0.5\%$ of input span
Linearity	Resistivity: $\pm 0.5\%$ of input span
Indication Accuracy	Temperature: $\pm 1^{\circ}\text{C}$
Input Sampling Period	250 ms (2 inputs)
Time Accuracy	Within $\pm 1\%$ of setting time

Standard Functions

Resistivity Calibration Span Adjustment	The Resistivity Calibration Span Adjustment is performed so that the resistivity input value matches the reference resistivity meter.			
Temperature Calibration	When a sensor cannot be set at the exact location where measurement is desired, the resulting measured temperature may deviate from the temperature in the desired location. In such a case, the desired temperature can be set for the desired location by setting a temperature calibration value. However, it is effective within the input rated range regardless of the temperature calibration value.			
Serial Communication	The following operations can be carried out from an external computer. (1) Reading and setting of various set values (2) Reading of resistivity, temperature and status (3) Function change, adjustment (4) Reading and setting of user save area			
Cable Length	1.2 km (Max), Cable resistance value: Within $50\ \Omega$ (Terminators are not necessary, but if used, use $120\ \Omega$ minimum on both sides.)			
Communication Line	EIA RS-485			
Communication Method	Half-duplex communication			
Communication Speed	9600, 19200, 38400 bps (Selectable by keypad)			
Synchronization Method	Start-stop synchronization			
Code Form	ASCII, Binary			
Communication Protocol	Shinko protocol, MODBUS ASCII, MODBUS RTU (Selectable by keypad)			
Data Bit/Parity	8 bits/No parity, 7 bits/No parity, 8 bits/Even, 7 bits/Even, 8 bits/Odd, 7 bits/Odd (Selectable by keypad)			
Stop Bit	1, 2 (Selectable by keypad)			
Error Correction	Command request repeat system			
Error Detection	Parity check, Checksum (Shinko protocol), LRC (MODBUS protocol ASCII), CRC-16 (MODBUS protocol RTU)			
Data Format	Communication Protocol	Shinko Protocol	MODBUS ASCII	MODBUS RTU
	Start bit	1	1	1
	Data bit	7	7 (8) Selectable	8
	Parity	Even	Even (No parity, Odd) Selectable	No parity (Even, Odd) Selectable
	Stop bit	1	1 (2) Selectable	1 (2) Selectable

Insulation/Dielectric Strength

<p>Circuit Insulation Configuration</p>	<p>When the corresponding option is ordered.</p> <p>Insulation Resistance: 10 MΩ minimum, at 500 V DC</p>
<p>Dielectric Strength</p>	<p>Between power terminal - ground (GND): 1.5 kV AC for 1 minute Between input terminal - ground (GND): 1.5 kV AC for 1 minute Between input terminal - power terminal: 1.5 kV AC for 1 minute</p>

Attached Functions

Set Value Lock	<p>Lock 1: None of the set values can be changed. Lock 2: Only A11, A12, A21, A22 values can be changed. Lock 3: All set values – except Measurement unit, Measurement range, Resistivity calibration value, Temperature calibration value, Transmission output 1 Zero and Span adjustment values, Transmission output 2 Zero and Span adjustment values – can be temporarily changed. However, they revert to their previous value after the power is turned off because they are not saved in the non-volatile IC memory.</p>				
Resistivity Input Sensor Correction	<p>This corrects the input value from the Resistivity Sensor. When resistivity measured by the sensor may deviate from the resistivity in the measured location, desired resistivity can be obtained by adding a sensor correction value. However, it is effective within the measurement range regardless of the sensor correction value.</p>				
Larger than Clip Value, Smaller than Measurement Range High Limit	<p>When Resistivity input value is larger than the clip value or smaller than the measurement range high limit, the following are indicated.</p>				
	Resistivity Display (CH1)			Temperature Display (CH2)	
	Temperature compensation method (p.28)		Measurement range cut function (p.37)	Measured temperature	
	<i>PURE</i> (*1)	Less than ultrapure water value	<input type="checkbox"/> <i>FF</i> (Disabled)		
			<input type="checkbox"/> <i>n</i> (Enabled)		
	Exceeding ultrapure water value	<input type="checkbox"/> <i>FF</i> (Disabled)	Ultrapure water value flashes. (*3)		
		<input type="checkbox"/> <i>n</i> (Enabled)	Ultrapure water value lights. (*3)		
	Any other items except <i>PURE</i>		<input type="checkbox"/> <i>FF</i> (Disabled)	Clip value flashes. (*2)	
			<input type="checkbox"/> <i>n</i> (Enabled)	Clip value lights. (*2)	
	<p>(*1) When <i>PURE</i> is selected in [Temperature compensation method], the resistivity measured value can be indicated only up to the ultrapure water value. (*2) Transmission output 1 and Transmission output 2 are fixed at the clip value. (*3) Transmission output 1 and Transmission output 2 are fixed at the selected ultrapure water value.</p>				
Outside Measurement Range	<p>When resistivity measured value is outside the measurement range, the following are indicated.</p>				
	Resistivity Display (CH1)			Temperature Display (CH2)	
	Resistivity measured value is higher than the Measurement range high limit:				
	Measurement range cut function (p.37)		Measured temperature		
	<input type="checkbox"/> <i>FF</i> (Disabled)	Measurement range high limit value flashes.			
	<input type="checkbox"/> <i>n</i> (Enabled)	Measurement range high limit value lights.			
	<p>When measured temperature is outside the measurement range, the following are indicated.</p>				
	Resistivity Display (CH1)			Temperature Display (CH2)	
Resistivity measured value			Less than 0.0°C: <i>Er04</i>		
Resistivity measured value			Exceeding 110.0°C: <i>Er03</i>		

Power Failure Countermeasure	The setting data is backed up in the non-volatile IC memory.			
Self-diagnosis	The CPU is monitored by a watchdog timer, and if an abnormal status occurs, the instrument is switched to warm-up status.			
Warm-up Indication	For approx. 4 seconds after the power is switched ON, the input characters are indicated on the Resistivity Display (CH1) and Temperature Display (CH2).			
	Display	Character	Measurement Unit	
	Resistivity Display (CH1)	<i>comb</i>	Resistivity (MΩ•cm)	
		<i>41 □□</i>	Resistivity (kΩ•m)	
	Display	Character	Input Temperature Spec (*)	[Pt100 Input Wire Type] Selection Item (p.29)
	Temperature Display (CH2)	<i>Pt□□</i>	Pt100	<i>Pt□□2</i> : 2-wire type
<i>Pt□□3</i>		<i>Pt□□3</i> : 3-wire type		
<i>Pt 10</i>		Pt1000		
(*) This input temperature specification was specified at the time of ordering.				
Display Sleep Function	Resistivity, Temperature or No indication can be selected in [Display selection (p.33)], which is indicated in Resistivity/Temperature Display Mode. If anything other than No indication is selected, and if indication time is set, the displays become unlit after the indication time has passed from no operation status. If any key is pressed, the display will re-light. If the indication time is set to 0 (zero), the display remains lit, and this function does not work.			
Auto-light Function	Automatically measures and controls brightness of the Resistivity Display (CH1), Temperature Display (CH2) and action indicators.			
Cable Length Correction	If <i>Pt□□2</i> (2-wire type) is selected in [Pt100 input wire type (p.29)], and if sensor cable is too long, temperature measurement error will occur due to cable resistance. This can be corrected by setting the Cable length correction value and Cable cross-section area.			
Error Code	The following error codes flash on the Temperature Display (CH2).			
	Error Code	Error Type	Error	Description
	<i>Er01</i>	Fail	Temperature sensor burnout	Temperature sensor lead wire is burnt out.
	<i>Er02</i>	Fail	Temperature sensor short-circuited	Temperature sensor lead wire is short-circuited.
	<i>Er03</i>	Err	Outside temperature compensation range	Measured temperature has exceeded 110.0°C.
<i>Er04</i>	Err	Outside temperature compensation range	Measured temperature is less than 0.0°C.	
When measuring or calibrating				

Other

Power Consumption	Approx. 8 VA
Ambient Temperature	0 to 50°C (32 to 122°F)
Ambient Humidity	35 to 85 %RH (non-condensing)
Weight	Approx. 200 g (including the socket)
Accessories Included	Instruction manual: 1 copy, Unit label: 1 sheet, Inspection report: 1 sheet
Accessories Sold Separately	Socket: ASK-001-1 (Finger-safe and screw fall prevention)
Environmental Spec	RoHS directive compliant

12.2 Optional Specifications

A□□ Output (Option Code: EVT or TA)

A□□ output	<p>If the measured value exceeds the A□□ value, the output will be turned ON for each A□□ type.</p> <p>A1 or A2 output is turned ON depending on the settings in [A1/A2 output allocation (p.34)] and in [Output ON time/OFF time when A1/A2 output ON (pp.34, 35)].</p> <p>Regardless of options being ordered, A□□ output status can be read by reading the Status flag 1 (A11, A12, A21, A22 output flag bit) in Serial communication.</p> <p>A□□ output status, when input errors occur, differs depending on the selections in [A□□ output when input errors occur (p.28)].</p> <ul style="list-style-type: none"> • If $\square F F \square$ (Disabled) is selected in [A□□ output when input errors occur (p.28)], A□□ output and A□□ output status will be turned OFF when input errors occur. • If $\square n \square \square$ (Enabled) is selected in [A□□ output when input errors occur (p.28)], A□□ output and A□□ output status will be maintained when input errors occur. <p>During Resistivity Calibration Span Adjustment, A□□ action is forced OFF. If Transmission output 1 (TA option) is ordered, only A1 output can be used.</p>																						
Action	ON/OFF action																						
A□□ ON side A□□ OFF side	<p>The setting range differs depending on the selection of A□□ type and measurement range.</p> <ul style="list-style-type: none"> • Resistivity input: <table border="1" data-bbox="475 943 1487 1267"> <thead> <tr> <th>Measurement Range</th> <th>Setting Range</th> </tr> </thead> <tbody> <tr> <td>0.000 to 0.200 MΩ·cm</td> <td>0.000 to 0.020 MΩ·cm</td> </tr> <tr> <td>0.00 to 2.00 MΩ·cm</td> <td>0.00 to 0.20 MΩ·cm</td> </tr> <tr> <td>0.00 to 20.00 MΩ·cm</td> <td>0.00 to 2.00 MΩ·cm</td> </tr> <tr> <td>0.0 to 100.0 MΩ·cm</td> <td>0.0 to 10.0 MΩ·cm</td> </tr> <tr> <td>0.00 to 2.00 kΩ·m</td> <td>0.00 to 0.20 kΩ·m</td> </tr> <tr> <td>0.0 to 20.0 kΩ·m</td> <td>0.0 to 2.0 kΩ·m</td> </tr> <tr> <td>0.0 to 200.0 kΩ·m</td> <td>0.0 to 20.0 kΩ·m</td> </tr> <tr> <td>0 to 1000 kΩ·m</td> <td>0 to 100 kΩ·m</td> </tr> </tbody> </table> <ul style="list-style-type: none"> • Temperature input: <table border="1" data-bbox="475 1312 1487 1379"> <thead> <tr> <th>Measurement Range</th> <th>Setting Range</th> </tr> </thead> <tbody> <tr> <td>0.0 to 100.0°C</td> <td>0.0 to 10.0°C</td> </tr> </tbody> </table>	Measurement Range	Setting Range	0.000 to 0.200 MΩ·cm	0.000 to 0.020 MΩ·cm	0.00 to 2.00 MΩ·cm	0.00 to 0.20 MΩ·cm	0.00 to 20.00 MΩ·cm	0.00 to 2.00 MΩ·cm	0.0 to 100.0 MΩ·cm	0.0 to 10.0 MΩ·cm	0.00 to 2.00 kΩ·m	0.00 to 0.20 kΩ·m	0.0 to 20.0 kΩ·m	0.0 to 2.0 kΩ·m	0.0 to 200.0 kΩ·m	0.0 to 20.0 kΩ·m	0 to 1000 kΩ·m	0 to 100 kΩ·m	Measurement Range	Setting Range	0.0 to 100.0°C	0.0 to 10.0°C
Measurement Range	Setting Range																						
0.000 to 0.200 MΩ·cm	0.000 to 0.020 MΩ·cm																						
0.00 to 2.00 MΩ·cm	0.00 to 0.20 MΩ·cm																						
0.00 to 20.00 MΩ·cm	0.00 to 2.00 MΩ·cm																						
0.0 to 100.0 MΩ·cm	0.0 to 10.0 MΩ·cm																						
0.00 to 2.00 kΩ·m	0.00 to 0.20 kΩ·m																						
0.0 to 20.0 kΩ·m	0.0 to 2.0 kΩ·m																						
0.0 to 200.0 kΩ·m	0.0 to 20.0 kΩ·m																						
0 to 1000 kΩ·m	0 to 100 kΩ·m																						
Measurement Range	Setting Range																						
0.0 to 100.0°C	0.0 to 10.0°C																						
A□□ High/Low limits independent upper side span, A□□ High/Low limits independent lower side span	<ul style="list-style-type: none"> • Resistivity input: Measurement range low limit to Measurement range high limit (*1) • Temperature input: 0.0 to 100.0°C (*2) <p>(*1) The measurement unit and decimal point place follow the measurement range. (*2) The decimal point place does not follow the selection. It is fixed.</p>																						
A□□ hysteresis	<p>Setting range differs depending on the selection of A□□ type and measurement range.</p> <ul style="list-style-type: none"> • Resistivity input: <table border="1" data-bbox="475 1686 1487 2011"> <thead> <tr> <th>Measurement Range</th> <th>Setting Range</th> </tr> </thead> <tbody> <tr> <td>0.000 to 0.200 MΩ·cm</td> <td>0.001 to 0.020 MΩ·cm</td> </tr> <tr> <td>0.00 to 2.00 MΩ·cm</td> <td>0.01 to 0.20 MΩ·cm</td> </tr> <tr> <td>0.00 to 20.00 MΩ·cm</td> <td>0.01 to 2.00 MΩ·cm</td> </tr> <tr> <td>0.0 to 100.0 MΩ·cm</td> <td>0.1 to 10.0 MΩ·cm</td> </tr> <tr> <td>0.00 to 2.00 kΩ·m</td> <td>0.01 to 0.20 kΩ·m</td> </tr> <tr> <td>0.0 to 20.0 kΩ·m</td> <td>0.1 to 2.0 kΩ·m</td> </tr> <tr> <td>0.0 to 200.0 kΩ·m</td> <td>0.1 to 20.0 kΩ·m</td> </tr> <tr> <td>0 to 1000 kΩ·m</td> <td>1 to 100 kΩ·m</td> </tr> </tbody> </table> <ul style="list-style-type: none"> • Temperature input: <table border="1" data-bbox="475 2056 1487 2112"> <thead> <tr> <th>Measurement Range</th> <th>Setting Range</th> </tr> </thead> <tbody> <tr> <td>0.0 to 100.0°C</td> <td>0.1 to 10.0°C</td> </tr> </tbody> </table>	Measurement Range	Setting Range	0.000 to 0.200 MΩ·cm	0.001 to 0.020 MΩ·cm	0.00 to 2.00 MΩ·cm	0.01 to 0.20 MΩ·cm	0.00 to 20.00 MΩ·cm	0.01 to 2.00 MΩ·cm	0.0 to 100.0 MΩ·cm	0.1 to 10.0 MΩ·cm	0.00 to 2.00 kΩ·m	0.01 to 0.20 kΩ·m	0.0 to 20.0 kΩ·m	0.1 to 2.0 kΩ·m	0.0 to 200.0 kΩ·m	0.1 to 20.0 kΩ·m	0 to 1000 kΩ·m	1 to 100 kΩ·m	Measurement Range	Setting Range	0.0 to 100.0°C	0.1 to 10.0°C
Measurement Range	Setting Range																						
0.000 to 0.200 MΩ·cm	0.001 to 0.020 MΩ·cm																						
0.00 to 2.00 MΩ·cm	0.01 to 0.20 MΩ·cm																						
0.00 to 20.00 MΩ·cm	0.01 to 2.00 MΩ·cm																						
0.0 to 100.0 MΩ·cm	0.1 to 10.0 MΩ·cm																						
0.00 to 2.00 kΩ·m	0.01 to 0.20 kΩ·m																						
0.0 to 20.0 kΩ·m	0.1 to 2.0 kΩ·m																						
0.0 to 200.0 kΩ·m	0.1 to 20.0 kΩ·m																						
0 to 1000 kΩ·m	1 to 100 kΩ·m																						
Measurement Range	Setting Range																						
0.0 to 100.0°C	0.1 to 10.0°C																						

A□□ type	<p>One type can be selected from the following via the keypad.</p> <ul style="list-style-type: none"> • No action • Resistivity input low limit action • Resistivity input high limit action • Temperature input low limit action • Temperature input high limit action • Error output [When the error type is “Error” (p.68), the output is turned ON.] • Fail output [When the error type is “Fail” (p.68), the output is turned ON.] • Resistivity input High/Low limits independent action • Temperature input High/Low limits independent action 	
Output	Relay contact 1a	
	Control capacity	3A 250 V AC (Resistive load) 1A 250 V AC (Inductive load $\cos\phi=0.4$)
	Electrical life	100,000 cycles
A□□ ON delay time	0 to 9999 seconds	
A□□ OFF delay time	0 to 9999 seconds	
A1, A2 output allocations	For A1 or A2 output, A11 type, A12 type, A21 type and/or A22 type can be allocated. Output is OR output.	
Output ON time/ OFF time when A1/A2 output ON	If Output ON time and OFF time are set, A1 or A2 output can be turned ON/OFF in a configured cycle when A1 or A2 output is ON.	
Resistivity input error alarm	<p>Detects actuator trouble.</p> <p>Even if resistivity input error alarm time has elapsed, and if resistivity input does not become higher than the resistivity input error alarm band, the unit assumes that actuator trouble has occurred, and sets Status flag 2 (A1, A2 resistivity input error alarm output flag bit).</p> <p>In Serial communication, status can be read by reading Status flag 2 (A1, A2 resistivity input error alarm output flag bit).</p> <p>Resistivity input error alarm is disabled during Resistivity Span adjustment.</p> <p>Resistivity input error alarm is enabled only when LE_L (Resistivity input low limit action) or LE_H (Resistivity input high limit action) is selected in [A11, A12, A21, A22 type (pp.22, 23)].</p>	

Transmission Output 1 (Option Code: TA)

Transmission Output 1	<p>Converting resistivity or temperature to analog signal every input sampling period, and outputs the value in current.</p> <p>If $\square F F \square$ (No temperature compensation) is selected in [Temperature compensation method (p.28)], and if $\Gamma E \bar{n} P$ (Temperature transmission) is selected in [Transmission output 1 type (p.31)], Transmission output 1 value will differ depending on the selection in [Temperature Display when no temperature compensation (p.33)] as follows.</p> <ul style="list-style-type: none"> • If $\square F F \square$ (Unlit) or $\surd \Gamma d \square$ (Reference temperature) is selected, the value set in [Reference temperature (p.29)] will be output. • If $Pb \square$ (Measured value) is selected, the measured value will be output. <p>If Transmission output 1 high limit and low limit are set to the same value, Transmission output 1 will be fixed at 4 mA DC.</p>	
	Resolution	12000
	Current	4 to 20 mA DC (Load resistance: Max. 550 Ω)
	Output accuracy	Within $\pm 0.3\%$ of Transmission output 1 span
Transmission output 1 adjustment	Fine adjustment of the Transmission output 1 can be performed via Transmission output 1 Zero and Span adjustments.	
Transmission output 1 status when calibrating	Selects Transmission output 1 status when calibrating resistivity.	
	Last value HOLD	Retains the last value before resistivity calibration, and outputs it.
	Set value HOLD	Outputs the value set in [Transmission output 1 value HOLD when calibrating].
	Measured value	Outputs the measured value when calibrating resistivity.

Transmission Output 2 (Option Code: TA2)

Transmission Output 2	<p>Converting resistivity or temperature to analog signal every input sampling period, and outputs the value in current.</p> <p>If $\square F F \square$ (No temperature compensation) is selected in [Temperature compensation method (p.28)], and if $\Gamma E \bar{n} P$ (Temperature transmission) is selected in [Transmission output 2 type (p.31)], Transmission output 2 value will differ depending on the selection in [Temperature Display when no temperature compensation (p.33)] as follows.</p> <ul style="list-style-type: none"> • If $\square F F \square$ (Unlit) or $\surd \Gamma d \square$ (Reference temperature) is selected, the value set in [Reference temperature (p.29)] will be output. • If $Pb \square$ (Measured value) is selected, the measured value will be output. <p>If Transmission output 2 high limit and low limit are set to the same value, Transmission output 2 will be fixed at 4 mA DC.</p>	
	Resolution	12000
	Current	4 to 20 mA DC (Load resistance: Max. 550 Ω)
	Output accuracy	Within $\pm 0.3\%$ of Transmission output 2 span
Transmission output 2 adjustment	Fine adjustment of the Transmission output 2 can be performed via Transmission output 2 Zero and Span adjustments.	
Transmission output 2 status when calibrating	Selects Transmission output 2 status when calibrating resistivity.	
	Last value HOLD	Retains the last value before resistivity calibration, and outputs it.
	Set value HOLD	Outputs the value set in [Transmission output 2 value HOLD when calibrating].
	Measured value	Outputs the measured value when calibrating resistivity.

13. Troubleshooting

If any malfunction occurs, refer to the following items after checking that power is being supplied to the WIL-102-SE.

13.1 Indication

Problem	Possible Cause	Solution
The Resistivity/Temperature Display is unlit.	$n0nE$ (No Indication) is selected in [Display selection (p.33)].	Select RL (Resistivity/Temperature).
	The time set in [Indication time (p.33)] has passed.	If any key is pressed while displays are unlit, they will re-light. Set the indication time to a suitable time-frame.
The Resistivity/Temperature Display is dark.	$U4E$ (Enabled) is selected in [Auto-light function (p.33)].	Select $----$ (Disabled).
Indication of the Resistivity/Temperature Display is unstable or irregular.	Resistivity calibration Span adjustment and temperature calibration may not have finished.	Perform resistivity calibration Span adjustment and temperature calibration.
	Specifications of 2-electrode Resistivity Sensor may not be suitable.	Replace the 2-electrode Resistivity Sensor with a suitable one.
	There may be equipment that interferes with or makes noise near the WIL-102-SE.	Keep WIL-102-SE clear of any potentially disruptive equipment. Try [Grounding of shield wire terminal (E)].
Temperature Display is unlit.	oFF (Unlit) is selected in [Temperature Display when no temperature compensation (p.33)].	Select Ref (Reference temperature) or PH (Measured value).
$[Er01]$ is flashing on the Temperature Display.	The temperature sensor lead wire is burnt out.	Replace the temperature sensor.
$[Er02]$ is flashing on the Temperature Display.	The temperature sensor lead wire is short-circuited.	Replace the temperature sensor.
$[Er03]$ is flashing on the Temperature Display.	Measured temperature has exceeded 110.0°C.	Check the environment of measurement location.
$[Er04]$ is flashing on the Temperature Display.	Measured temperature is less than 0.0°C.	Check the environment of measurement location.
$[Err1]$ is indicating on the Resistivity Display.	Internal memory is defective.	Contact our agency or us.

- Grounding of shield wire terminal (E)

If the indication fluctuates due to noise, ground the shield wire terminal (E).





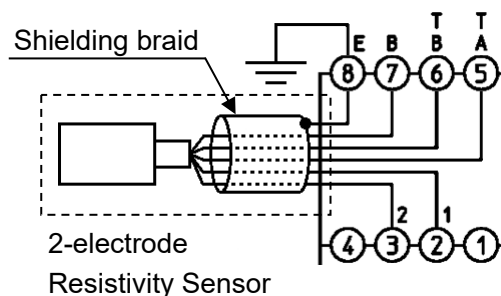

However, depending on the installation environment, the symptom may not be improved.

In this case, disconnect the grounding of the shield wire terminal (E) and return it to the original state.

(Depending on the type of sensor, the cable for the shield wire terminal (E) may not be available.)



13.2 Key Operation

Problem	Possible Cause	Solution
<ul style="list-style-type: none"> • None of the values can be changed. • The values do not change by the ,  keys. 	L O C 1 (Lock 1) is selected in [Set value lock (p.30)].	Select  (Unlock).
<ul style="list-style-type: none"> • Only A□□ value can be set. Other settings are impossible. • The values do not change by the ,  keys. 	L O C 2 (Lock 2) is selected in [Set value lock (p.30)].	Select  (Unlock).

13.3 Communication

Check that power is being supplied to the master and slave that customers use.

If communication failure still occurs, check the following.

Problem	Possible Cause	Solution
Communication failure	Communication cable is not securely connected, or is disconnected/defective.	Check the communication cable and connector.
	Incorrect wiring of the communication cable and/or connector	Check the communication cable and connector.
	Imperfect contact between the communication cable and the connector, or between the communication connector and instrument port	Check the communication cable and connector.
	Communication speed of the slave does not match that of the master.	Check the communication speed of the slave and master.
	The data bit, parity and stop bit of the master do not correspond to those of the slave.	Check the data bit, parity and stop bit of the master and the slave.
	The instrument number (address) of the slave does not correspond to that of the command.	Check the instrument number (address) of the slave and command.
	The instrument numbers (addresses) are duplicated in multiple slaves.	Check the instrument numbers (addresses) of the slave.
	Make sure that the program is appropriate for the transmission timing.	Check the program.
Although communication is occurring, the response is negative acknowledgement.	A non-existent command code has been sent.	Check the command code.
	The setting command data exceeds the setting range of the slave.	Check the setting range of the slave.
	The WIL-102-SE cannot be set during calibration mode.	Check the slave status.
	The WIL-102-SE is in front keypad operation setting mode.	Return the unit to Resistivity/ Temperature Display Mode.

For all other malfunctions, please contact our main office or dealers.

14. Temperature Compensation Method

14.1 How to Input Temperature Coefficient

Temperature compensation is conducted using temperature coefficient (%/°C) and a randomly selected reference temperature.

Conductivity of the solution varies depending on the temperature.

If solution temperature rises by 1°C, the conductivity rises by 2% at 25°C basis in general.

Temperature coefficient differs depending on the solution type and its concentration, which ranges from 0.50 to 2.50.

By inputting the temperature coefficient, temperature compensation can be calculated to find the conductivity at 25°C.

Temperature coefficient 2.00 %/°C can be used for most of solutions.

If temperature coefficient of solution is already-known, enter the value.

If the conductivity at an arbitrary temperature T°C is already-known, and if reference temperature is ST°C, conductivity C_(ST) at the reference temperature can be obtained according to the following formula.

$$C_{(ST)} = \frac{C_{(T)}}{(1 + 0.01 \times \alpha \times (T - ST))}$$

C_(ST): Conductivity of the solution at ST°C

C_(T): Conductivity of the solution at T°C

α: Temperature coefficient of conductivity (%)

T: Arbitrary temperature T°C

ST: Reference temperature ST°C

14.2 Temperature Compensation Based on the Temperature Characteristics of Deionized Water

Conductivity of deionized water is calculated by adding conductivity of deionized water to conductivity caused by ionic impurities.

$$C_{(T)} = F_{(T)} + G_{(T)}$$

$C_{(T)}$: Conductivity of solution at $T^{\circ}\text{C}$

$F_{(T)}$: Conductivity of deionized water at $T^{\circ}\text{C}$

$G_{(T)}$: Conductivity caused by ionic impurities at $T^{\circ}\text{C}$

Conductivity of Deionized Water

Conductivity of deionized water is caused by dissociation of water molecules.

The dissociation of water molecules is greatly affected by the change of temperature.

Conductivity of deionized water is measured based on the characteristics in (Table 14.2-1)

(ASTM D 1125-91, JISK0130-1995).

(Table 14.2-1)

Temperature (°C)	Conductivity (μS/cm)
0	0.012
5	0.017
10	0.023
15	0.031
20	0.042
25	0.055
30	0.071
35	0.090
40	0.114
45	0.141
50	0.173
55	0.210
60	0.251
65	0.299
70	0.352
75	0.410
80	0.474
85	0.544
90	0.621
95	0.703
100	0.793

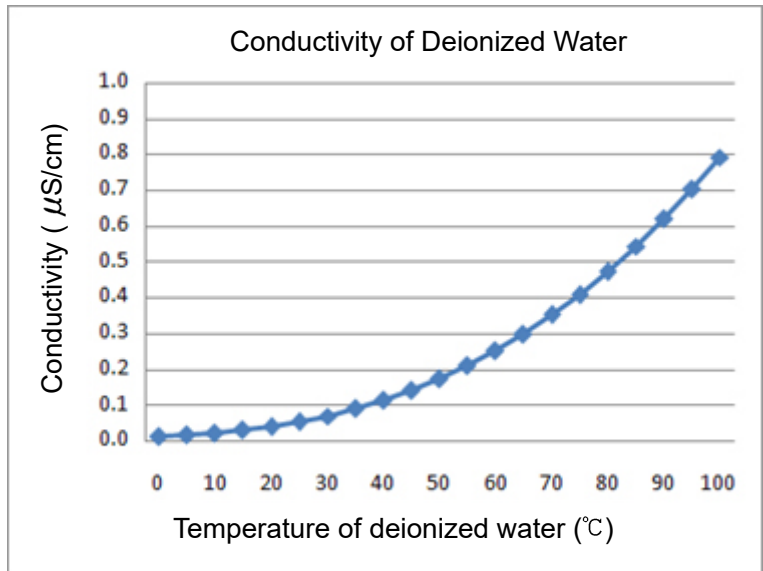

(Fig.14.2-1)

Conductivity Caused by Ionic Impurities

Conductivity caused by ionic impurities can be calculated using temperature coefficient 2 %/°C in Section 14.1 (p.74).

15. Character Tables

The following shows our character tables. Use data column for your reference.

Setting Groups

Character	Setting Group
<i>F.nc.1</i>	Resistivity Input Group
<i>F.nc.2</i>	Temperature Input Group
<i>a.F.E.r</i>	Basic Function Group

Temperature Calibration Mode

Character	Setting Item, Setting Range	Factory Default	Data
<i>40.00</i> (*)	Temperature calibration	0.0°C	
<i>00.00</i>	Setting range: -10.0 to 10.0°C		

(*) *40.00* and measured temperature are displayed alternately.

Resistivity Error Calibration Span Adjustment

Character	Setting Item, Setting Range	Factory Default	Data
<i>Adj4</i> (*)	Span adjustment	1.000	
<i>1000</i>	Setting range: 0.700 to 1.300		

(*) *Adj4* and measured resistivity are displayed alternately.

Transmission Output 1 Adjustment Mode

Character	Setting Item, Setting Range	Factory Default	Data
<i>Adj1</i>	Transmission output 1 Zero adjustment value	0.00%	
<i>0000</i>	Setting range: ±5.00% of Transmission output 1 span		
<i>Adj1</i>	Transmission output 1 Span adjustment value	0.00%	
<i>0000</i>	Setting range: ±5.00% of Transmission output 1 span		

Transmission Output 2 Adjustment Mode

Character	Setting Item, Setting Range	Factory Default	Data
<i>Adj2</i>	Transmission output 2 Zero adjustment value	0.00%	
<i>0000</i>	Setting range: ±5.00% of Transmission output 2 span		
<i>Adj2</i>	Transmission output 2 Span adjustment value	0.00%	
<i>0000</i>	Setting range: ±5.00% of Transmission output 2 span		

Resistivity Input Group

Character	Setting Item, Setting Range	Factory Default	Data
<i>cELl</i>	Sensor cell constant	0.01/cm	
<i>0001</i>	0.01/cm Fixed		
<i>coEF</i>	Cell constant correction value	1.000	
<i>1000</i>	Setting range: 0.001 to 5.000		
<i>Unit</i>	Measurement unit	Resistivity (MΩ•cm)	
<i>conB</i>	<i>conB</i> : Resistivity (MΩ•cm) <i>41</i> : Resistivity (kΩ•m)		

Character	Setting Item, Setting Range	Factory Default	Data
Rr nG 2000	Measurement range	0.00 to 20.00 MΩ·cm	
	Measurement Unit	Selection Item	Measurement Range
	Resistivity (MΩ·cm)	0.200	0.000 to 0.200 MΩ·cm
		2.000	0.00 to 2.00 MΩ·cm
		20.000	0.00 to 20.00 MΩ·cm
		100.0	0.0 to 100.0 MΩ·cm
	Resistivity (kΩ·m)	0.200	0.00 to 2.00 kΩ·m
		2.000	0.0 to 20.0 kΩ·m
20.000		0.0 to 200.0 kΩ·m	
100.0		0 to 1000 kΩ·m	
PUrE 18.18	Ultrapure water value	18.18	
	Measurement Unit	Selection Item	Ultrapure Water Value
	Resistivity (MΩ·cm)	18.18	18.18
		18.23	18.23
		18.24	18.24
	Resistivity (kΩ·m)	18.18	181.8
		18.23	182.3
		18.24	182.4
cLlP 18.18	Clip value	18.18 MΩ·cm	
	Setting range: 0.00 to Measurement range high limit or Selected ultrapure water value		
A11F [----]	A11 type	No action	
	[----] : No action 4E_L : Resistivity input low limit action 4E_H : Resistivity input high limit action rAPL : Temperature input low limit action rAPH : Temperature input high limit action ErOf : Error output FRIL : Fail output 4EHL : Resistivity input High/Low limits independent action rAHL : Temperature input High/Low limits independent action		
	A12F [----]	A12 type	No action
		Selection items are the same as those of A11 type.	
	A21F [----]	A21 type	No action
		Selection items are the same as those of A11 type.	
	A22F [----]	A22 type	No action
		Selection items are the same as those of A11 type.	
A11 [000]	A11 value	Resistivity input: 0.00 MΩ·cm, Temperature input: 0.0°C	
	Setting range: Resistivity input: Measurement range low limit to Measurement range high limit (*1) Temperature input: 0.0 to 100.0°C (*2)		
A12 [000]	A12 value	Resistivity input: 0.00 MΩ·cm, Temperature input: 0.0°C	
	Setting ranges are the same as those of A11 value.		
A21 [000]	A21 value	Resistivity input: 0.00 MΩ·cm, Temperature input: 0.0°C	
	Setting ranges are the same as those of A11 value.		

(*1) The measurement unit and decimal point place follow the measurement range.

(*2) The placement of the decimal point does not follow the selection. It is fixed.

Character	Setting Item, Setting Range	Factory Default	Data																								
A22 000	A22 value Setting ranges are the same as those of A11 value (p.77).	Resistivity input: 0.00 MΩ•cm, Temperature input: 0.0°C																									
A11d 4d1 F	A11 hysteresis type 2d1 F : Medium Value 4d1 F : Reference Value	Reference Value																									
A11U 001	A11 ON side Resistivity input: <table border="1"> <thead> <tr> <th>Measurement Range</th> <th>Setting Range</th> </tr> </thead> <tbody> <tr> <td>0.000 to 0.200 MΩ•cm</td> <td>0.000 to 0.020 MΩ•cm</td> </tr> <tr> <td>0.00 to 2.00 MΩ•cm</td> <td>0.00 to 0.20 MΩ•cm</td> </tr> <tr> <td>0.00 to 20.00 MΩ•cm</td> <td>0.00 to 2.00 MΩ•cm</td> </tr> <tr> <td>0.0 to 100.0 MΩ•cm</td> <td>0.0 to 10.0 MΩ•cm</td> </tr> <tr> <td>0.00 to 2.00 kΩ•m</td> <td>0.00 to 0.20 kΩ•m</td> </tr> <tr> <td>0.0 to 20.0 kΩ•m</td> <td>0.0 to 2.0 kΩ•m</td> </tr> <tr> <td>0.0 to 200.0 kΩ•m</td> <td>0.0 to 20.0 kΩ•m</td> </tr> <tr> <td>0 to 1000 kΩ•m</td> <td>0 to 100 kΩ•m</td> </tr> <tr> <td>0.0 to 100.0°C</td> <td>0.0 to 10.0°C</td> </tr> </tbody> </table> Temperature input: <table border="1"> <thead> <tr> <th>Measurement Range</th> <th>Setting Range</th> </tr> </thead> <tbody> <tr> <td>0.0 to 100.0°C</td> <td>0.0 to 10.0°C</td> </tr> </tbody> </table>	Measurement Range	Setting Range	0.000 to 0.200 MΩ•cm	0.000 to 0.020 MΩ•cm	0.00 to 2.00 MΩ•cm	0.00 to 0.20 MΩ•cm	0.00 to 20.00 MΩ•cm	0.00 to 2.00 MΩ•cm	0.0 to 100.0 MΩ•cm	0.0 to 10.0 MΩ•cm	0.00 to 2.00 kΩ•m	0.00 to 0.20 kΩ•m	0.0 to 20.0 kΩ•m	0.0 to 2.0 kΩ•m	0.0 to 200.0 kΩ•m	0.0 to 20.0 kΩ•m	0 to 1000 kΩ•m	0 to 100 kΩ•m	0.0 to 100.0°C	0.0 to 10.0°C	Measurement Range	Setting Range	0.0 to 100.0°C	0.0 to 10.0°C	Resistivity input: 0.01 MΩ•cm, Temperature input: 1.0°C	
Measurement Range	Setting Range																										
0.000 to 0.200 MΩ•cm	0.000 to 0.020 MΩ•cm																										
0.00 to 2.00 MΩ•cm	0.00 to 0.20 MΩ•cm																										
0.00 to 20.00 MΩ•cm	0.00 to 2.00 MΩ•cm																										
0.0 to 100.0 MΩ•cm	0.0 to 10.0 MΩ•cm																										
0.00 to 2.00 kΩ•m	0.00 to 0.20 kΩ•m																										
0.0 to 20.0 kΩ•m	0.0 to 2.0 kΩ•m																										
0.0 to 200.0 kΩ•m	0.0 to 20.0 kΩ•m																										
0 to 1000 kΩ•m	0 to 100 kΩ•m																										
0.0 to 100.0°C	0.0 to 10.0°C																										
Measurement Range	Setting Range																										
0.0 to 100.0°C	0.0 to 10.0°C																										
A11L 001	A11 OFF side For the setting range, refer to A11 ON side (p.75).	Resistivity input: 0.01 MΩ•cm, Temperature input: 1.0°C																									
A12d 4d1 F	A12 hysteresis type For the selection items, refer to A11 hysteresis type (p.75).	Reference Value																									
A12U 001	A12 ON side For the setting range, refer to A11 ON side (p.75).	Resistivity input: 0.01 MΩ•cm, Temperature input: 1.0°C																									
A12L 001	A12 OFF side For the setting range, refer to A11 ON side (p.75).	Resistivity input: 0.01 MΩ•cm, Temperature input: 1.0°C																									
A21d 4d1 F	A21 hysteresis type For the selection items, refer to A11 hysteresis type (p.75).	Reference Value																									
A21U 001	A21 ON side For the setting range, refer to A11 ON side (p.75).	Resistivity input: 0.01 MΩ•cm, Temperature input: 1.0°C																									
A21L 001	A21 OFF side For the setting range, refer to A11 ON side (p.75).	Resistivity input: 0.01 MΩ•cm, Temperature input: 1.0°C																									
A22d 4d1 F	A22 hysteresis type For the selection items, refer to A11 hysteresis type (p.75).	Reference Value																									
A22U 001	A22 ON side For the setting range, refer to A11 ON side (p.75).	Resistivity input: 0.01 MΩ•cm, Temperature input: 1.0°C																									
A22L 001	A22 OFF side For the setting range, refer to A11 ON side (p.75).	Resistivity input: 0.01 MΩ•cm, Temperature input: 1.0°C																									
A11a 000	A11 ON delay time Setting range: 0 to 9999 seconds	0 seconds																									
A12a 000	A12 ON delay time Setting range: 0 to 9999 seconds	0 seconds																									
A21a 000	A21 ON delay time Setting range: 0 to 9999 seconds	0 seconds																									
A22a 000	A22 ON delay time Setting range: 0 to 9999 seconds	0 seconds																									
A11c 000	A11 OFF delay time Setting range: 0 to 9999 seconds	0 seconds																									
A12c 000	A12 OFF delay time Setting range: 0 to 9999 seconds	0 seconds																									

Character	Setting Item, Setting Range	Factory Default	Data																								
A21c □□□□	A21 OFF delay time Setting range: 0 to 9999 seconds	0 seconds																									
A22c □□□□	A22 OFF delay time Setting range: 0 to 9999 seconds	0 seconds																									
A11n □□□□	A11 High/Low limits independent lower side span Resistivity input: Measurement range low limit to Measurement range high limit (*1) Temperature input: 0.0 to 100.0°C (*2)	Resistivity input: 0.00 MΩ•cm Temperature input: 0.0°C																									
A12n □□□□	A12 High/Low limits independent lower side span For the setting range, refer to A11 High/Low limits independent lower side span (p.76).	Resistivity input: 0.00 MΩ•cm Temperature input: 0.0°C																									
A21n □□□□	A21 High/Low limits independent lower side span For the setting range, refer to A11 High/Low limits independent lower side span (p.76).	Resistivity input: 0.00 MΩ•cm Temperature input: 0.0°C																									
A22n □□□□	A22 High/Low limits independent lower side span For the setting range, refer to A11 High/Low limits independent lower side span (p.76).	Resistivity input: 0.00 MΩ•cm Temperature input: 0.0°C																									
A11P □□□□	A11 High/Low limits independent upper side span Resistivity input: Measurement range low limit to Measurement range high limit (*1) Temperature input: 0.0 to 100.0°C (*2)	Resistivity input: 0.00 MΩ•cm Temperature input: 0.0°C																									
A12P □□□□	A12 High/Low limits independent upper side span For the setting range, refer to A11 High/Low limits independent upper side span (p.76).	Resistivity input: 0.00 MΩ•cm Temperature input: 0.0°C																									
A21P □□□□	A21 High/Low limits independent upper side span For the setting range, refer to A11 High/Low limits independent upper side span (p.76).	Resistivity input: 0.00 MΩ•cm Temperature input: 0.0°C																									
A22P □□□□	A22 High/Low limits independent upper side span For the setting range, refer to A11 High/Low limits independent upper side span (p.76).	Resistivity input: 0.00 MΩ•cm Temperature input: 0.0°C																									
A11H □□□□	A11 hysteresis Resistivity input: <table border="1" data-bbox="395 1563 1310 1921"> <thead> <tr> <th>Measurement Range</th> <th>Setting Range</th> </tr> </thead> <tbody> <tr> <td>0.000 to 0.200 MΩ•cm</td> <td>0.001 to 0.020 MΩ•cm</td> </tr> <tr> <td>0.00 to 2.00 MΩ•cm</td> <td>0.01 to 0.20 MΩ•cm</td> </tr> <tr> <td>0.00 to 20.00 MΩ•cm</td> <td>0.01 to 2.00 MΩ•cm</td> </tr> <tr> <td>0.0 to 100.0 MΩ•cm</td> <td>0.1 to 10.0 MΩ•cm</td> </tr> <tr> <td>0.00 to 2.00 kΩ•m</td> <td>0.01 to 0.20 kΩ•m</td> </tr> <tr> <td>0.0 to 20.0 kΩ•m</td> <td>0.1 to 2.0 kΩ•m</td> </tr> <tr> <td>0.0 to 200.0 kΩ•m</td> <td>0.1 to 20.0 kΩ•m</td> </tr> <tr> <td>0 to 1000 kΩ•m</td> <td>1 to 100 kΩ•m</td> </tr> <tr> <td>0.0 to 100.0°C</td> <td>0.1 to 10.0°C</td> </tr> </tbody> </table> Temperature input: <table border="1" data-bbox="395 1966 1310 2042"> <thead> <tr> <th>Measurement Range</th> <th>Setting Range</th> </tr> </thead> <tbody> <tr> <td>0.0 to 100.0°C</td> <td>0.10 to 10.0°C</td> </tr> </tbody> </table>	Measurement Range	Setting Range	0.000 to 0.200 MΩ•cm	0.001 to 0.020 MΩ•cm	0.00 to 2.00 MΩ•cm	0.01 to 0.20 MΩ•cm	0.00 to 20.00 MΩ•cm	0.01 to 2.00 MΩ•cm	0.0 to 100.0 MΩ•cm	0.1 to 10.0 MΩ•cm	0.00 to 2.00 kΩ•m	0.01 to 0.20 kΩ•m	0.0 to 20.0 kΩ•m	0.1 to 2.0 kΩ•m	0.0 to 200.0 kΩ•m	0.1 to 20.0 kΩ•m	0 to 1000 kΩ•m	1 to 100 kΩ•m	0.0 to 100.0°C	0.1 to 10.0°C	Measurement Range	Setting Range	0.0 to 100.0°C	0.10 to 10.0°C	Resistivity input: 0.01 MΩ•cm Temperature input: 1.0°C	
Measurement Range	Setting Range																										
0.000 to 0.200 MΩ•cm	0.001 to 0.020 MΩ•cm																										
0.00 to 2.00 MΩ•cm	0.01 to 0.20 MΩ•cm																										
0.00 to 20.00 MΩ•cm	0.01 to 2.00 MΩ•cm																										
0.0 to 100.0 MΩ•cm	0.1 to 10.0 MΩ•cm																										
0.00 to 2.00 kΩ•m	0.01 to 0.20 kΩ•m																										
0.0 to 20.0 kΩ•m	0.1 to 2.0 kΩ•m																										
0.0 to 200.0 kΩ•m	0.1 to 20.0 kΩ•m																										
0 to 1000 kΩ•m	1 to 100 kΩ•m																										
0.0 to 100.0°C	0.1 to 10.0°C																										
Measurement Range	Setting Range																										
0.0 to 100.0°C	0.10 to 10.0°C																										

(*1) The measurement unit and decimal point place follow the measurement range.

(*2) The placement of the decimal point does not follow the selection. It is fixed.

Character	Setting Item, Setting Range	Factory Default	Data
A12H □□□	A12 hysteresis For the setting range, refer to A11 hysteresis (p.79).	Resistivity input: 0.01 MΩ·cm Temperature input: 1.0°C	
A21H □□□	A21 hysteresis For the setting range, refer to A11 hysteresis (p.79).	Resistivity input: 0.01 MΩ·cm Temperature input: 1.0°C	
A22H □□□	A22 hysteresis For the setting range, refer to A11 hysteresis (p.79).	Resistivity input: 0.01 MΩ·cm Temperature input: 1.0°C	
IErr OFF□	A□□ output when input errors occur on□□ : Enabled OFF□ : Disabled	Disabled	
F1F1 □□□	Resistivity input filter time constant Setting range: 0.0 to 10.0 seconds	0.0 seconds	
44□ □□□	Resistivity input sensor correction Setting range: ±10% of measurement span (*)	0.00 MΩ·cm	
dFcF □□□	Resistivity inputs for moving average Setting range: 1 to 120	20	

(*) The measurement unit and decimal point place follow the measurement range.

Temperature Input Group

Character	Setting Item, Setting Range	Factory Default	Data
Tc□ PUrE	Temperature compensation method PUrE : Temperature compensation is conducted using temperature characteristics of deionized water. PU4r : Temperature compensation is conducted using temperature characteristics of deionized water and impure substance. TcoE : Temperature compensation is conducted using temperature coefficient (%/°C) and randomly selected reference temperature. OFF□ : No temperature compensation	Temperature characteristics of deionized water	
tcoE □□□	Temperature coefficient Setting range: -5.00 to 5.00 %/°C	2.00 %/°C	
4rnd □□□	Reference temperature Setting range: 5.0 to 95.0°C (*)	25.0°C	
dP2□ □□□	Decimal point place □□□□ : No decimal point □□□□ : 1 digit after decimal point	1 digit after decimal point	
conE PF□3	Pt100 input wire type PF□2 : 2-wire type PF□3 : 3-wire type	3-wire type	
cAbL □□□	Cable length correction Setting range: 0.0 to 100.0 m	0.0 m	
c4Ec □□□	Cable cross-section area Setting range: 0.10 to 2.00 mm ²	0.30 mm ²	
F1F2 □□□	Temperature input filter time constant Setting range: 0.0 to 10.0 seconds	0.0 seconds	
dFcF □□□	Temperature inputs for moving average Setting range: 1 to 120	20	

(*) The placement of the decimal point follows the selection.

Basic Function Group

Character	Setting Item, Setting Range	Factory Default	Data
<i>Locb</i> [---]	Set value lock [---] : Unlock <i>Loc1</i> : Lock 1 <i>Loc2</i> : Lock 2 <i>Loc3</i> : Lock 3	Unlock	
<i>cn4L</i> <i>no4L</i>	Communication protocol <i>no4L</i> : Shinko protocol <i>no4A</i> : MODBUS ASCII mode <i>no4R</i> : MODBUS RTU mode	Shinko protocol	
<i>cnno</i> [000]	Instrument number Setting range: 0 to 95	0	
<i>cn4P</i> [096]	Communication speed [096] : 9600 bps [192] : 19200 bps [384] : 38400 bps	9600 bps	
<i>cnFF</i> <i>7EBn</i>	Data bit/Parity <i>8non</i> : 8 bits/No parity <i>7non</i> : 7 bits/No parity <i>8EBn</i> : 8 bits/Even <i>7EBn</i> : 7 bits/Even <i>8odd</i> : 8 bits/Odd <i>7odd</i> : 7 bits/Odd	7 bits/Even	
<i>cn4F</i> [001]	Stop bit [001] : 1 bit [002] : 2 bits	1 bit	
<i>Fr01</i> 4E[]	Transmission output 1 type 4E[] : Resistivity transmission 7E7P : Temperature transmission	Resistivity transmission	
<i>FrH1</i> 2000	Transmission output 1 high limit Resistivity transmission: Transmission output 1 low limit to Resistivity range high limit Temperature transmission: Transmission output 1 low limit to 100.0°C	Resistivity transmission: 20.00 MΩ·cm Temperature transmission: 100.0°C	
<i>FrL1</i> [000]	Transmission output 1 low limit Resistivity transmission: Resistivity range low limit to Transmission output 1 high limit Temperature transmission: 0.0°C to Transmission output 1 high limit	Resistivity transmission: 0.00 MΩ·cm Temperature transmission: 0.0°C	
<i>Fr02</i> 7E7P	Transmission output 2 type 4E[] : Resistivity transmission 7E7P : Temperature transmission	Temperature transmission	
<i>FrH2</i> 1000	Transmission output 2 high limit Resistivity transmission: Transmission output 2 low limit to Resistivity range high limit Temperature transmission: Transmission output 2 low limit to 100.0°C	Resistivity transmission: 20.00 MΩ·cm, Temperature transmission: 100.0°C	
<i>FrL2</i> [000]	Transmission output 2 low limit Resistivity transmission: Resistivity range low limit to Transmission output 2 high limit Temperature transmission: 0.0°C to Transmission output 2 high limit	Resistivity transmission: 0.00 MΩ·cm Temperature transmission: 0.0°C	

Character	Setting Item, Setting Range	Factory Default	Data														
<i>Trc1</i> <i>bEFH</i>	Transmission output 1 status when calibrating <i>bEFH</i> : Last value HOLD <i>4EFH</i> : Set value HOLD <i>PHH</i> : Measured value	Last value HOLD															
<i>Tr41</i> <i>0000</i>	Transmission output 1 value HOLD when calibrating Resistivity transmission: Resistivity range low limit to Resistivity range high limit Temperature transmission: 0.0 to 100.0°C	Resistivity transmission: 0.00 MΩ·cm Temperature transmission: 0.0°C															
<i>Trc2</i> <i>bEFH</i>	Transmission output 2 status when calibrating <i>bEFH</i> : Last value HOLD <i>4EFH</i> : Set value HOLD <i>PHH</i> : Measured value	Last value HOLD															
<i>Tr42</i> <i>0000</i>	Transmission output 2 value HOLD when calibrating Resistivity transmission: Resistivity range low limit to Resistivity range high limit Temperature transmission: 0.0 to 100.0°C	Resistivity transmission: 0.00 MΩ·cm Temperature transmission: 0.0°C															
<i>LI GF</i> <i>----</i>	Auto-light function <i>----</i> : Disabled <i>U4E</i> : Enabled	Disabled															
<i>di 4P</i> <i>ALL</i>	Display selection	Resistivity/Temperature															
	<table border="1"> <thead> <tr> <th></th> <th>Resistivity Display (CH1)</th> <th>Temperature Display (CH2)</th> </tr> </thead> <tbody> <tr> <td><i>ALL</i></td> <td>Resistivity</td> <td>Temperature</td> </tr> <tr> <td><i>4E</i></td> <td>Resistivity</td> <td>No indication</td> </tr> <tr> <td><i>TE nP</i></td> <td>No indication</td> <td>Temperature</td> </tr> <tr> <td><i>none</i></td> <td>No indication</td> <td>No indication</td> </tr> </tbody> </table>		Resistivity Display (CH1)	Temperature Display (CH2)	<i>ALL</i>	Resistivity	Temperature	<i>4E</i>	Resistivity	No indication	<i>TE nP</i>	No indication	Temperature	<i>none</i>	No indication	No indication	
	Resistivity Display (CH1)	Temperature Display (CH2)															
<i>ALL</i>	Resistivity	Temperature															
<i>4E</i>	Resistivity	No indication															
<i>TE nP</i>	No indication	Temperature															
<i>none</i>	No indication	No indication															
<i>TI nE</i> <i>0000</i>	Indication time Setting range: 00.01 to 60.00 (Minutes.Seconds)	00.00															
<i>oFdP</i> <i>oFF</i>	Temperature Display when no temperature compensation <i>oFF</i> : Unlit <i>4Fd</i> : Reference temperature <i>PH</i> : Measured value	Unlit															
<i>A1oF</i> <i>A11</i>	A1 output allocation <i>A11</i> : A11 type <i>A12</i> : A12 type <i>A21</i> : A21 type <i>A22</i> : A22 type <i>A1A1</i> : A11, A12 types <i>A2A1</i> : A21, A22 types <i>A1A2</i> : A11, A21 types <i>A2A2</i> : A12, A22 types <i>ALL</i> : A11, A12, A21, A22 types	A11 type															
<i>A2oF</i> <i>A21</i>	A2 output allocation For the selection item, refer to A1 output allocation (p.82).	A21 type															
<i>oon1</i> <i>0000</i>	Output ON time when A1 output is ON Setting range: 0 to 9999 seconds	0 seconds															
<i>oof1</i> <i>0000</i>	Output OFF time when A1 output is ON Setting range: 0 to 9999 seconds	0 seconds															
<i>oon2</i> <i>0000</i>	Output ON time when A2 output is ON Setting range: 0 to 9999 seconds	0 seconds															

Character	Setting Item, Setting Range	Factory Default	Data
oof2 □□□□	Output OFF time when A2 output is ON Setting range: 0 to 9999 seconds	0 seconds	
R14□ □□□□	A1 resistivity input error alarm A□□ type □□□□ : No action R11□ : A11 type R12□ : A12 type R21□ : A21 type R22□ : A22 type	No action	
R24□ □□□□	A2 resistivity input error alarm A□□ type □□□□ : No action R11□ : A11 type R12□ : A12 type R21□ : A21 type R22□ : A22 type	No action	
R14o □□□□	A1 resistivity input error alarm band when A□□ output ON Setting range: Resistivity range low limit to Resistivity range high limit (*1)	0.00 MΩ•cm	
R1of □□□□	A1 resistivity input error alarm time when A□□ output ON Setting range: 0 to 9999 seconds or minutes (*2)	0 seconds	
R14c □□□□	A1 resistivity input error alarm band when A□□ output OFF Setting range: Resistivity range low limit to Resistivity range high limit (*1)	0.00 MΩ•cm	
R1cf □□□□	A1 resistivity input error alarm time when A□□ output OFF Setting range: 0 to 9999 seconds or minutes (*2)	0 seconds	
R24o □□□□	A2 resistivity input error alarm band when A□□ output ON Setting range: Resistivity range low limit to Resistivity range high limit (*1)	0.00 MΩ•cm	
R2of □□□□	A2 resistivity input error alarm time when A□□ output ON Setting range: 0 to 9999 seconds or minutes (*2)	0 seconds	
R24c □□□□	A2 resistivity input error alarm band when A□□ output OFF Setting range: Resistivity range low limit to Resistivity range high limit (*1)	0.00 MΩ•cm	
R2cf □□□□	A2 resistivity input error alarm time when A□□ output OFF Setting range: 0 to 9999 seconds or minutes (*2)	0 seconds	
n_4□ 4Ec□	Resistivity input error alarm time unit 4Ec□: Second(s) n/n□: Minute(s)	Second(s)	
rcwf off□	Measurement range cut function off□: Disabled on□: Enabled	Disabled	

(*1) The measurement unit and decimal point place follow the measurement range.

(*2) The time unit depends on the selection in [Resistivity input error alarm time unit].

***** Inquiries *****

For any inquiries about this unit, please contact our agency or the vendor where you purchased the unit. Please provide your model and serial number.

[Example]

- Model ----- WIL-102-SE
- Serial number ----- No. 194F05000

In addition to the above, please let us know the details of the malfunction, or discrepancy, and the operating conditions.

SHINKO TECHNOS CO., LTD.
OVERSEAS DIVISION

Head Office: 2-5-1, Senbahigashi, Minoo, Osaka, 562-0035, Japan

[URL] <https://shinko-technos.co.jp/e/>

Tel: +81-72-727-6100

[E-mail] overseas@shinko-technos.co.jp

Fax: +81-72-727-7006