

Alarm Detector (DC voltage) (with indication function)

Model: **SAVA**

Features

- Scaling function
- Alarm Energized/De-energized
- Alarm Hold function
- Alarm action delay timer
- Set value lock

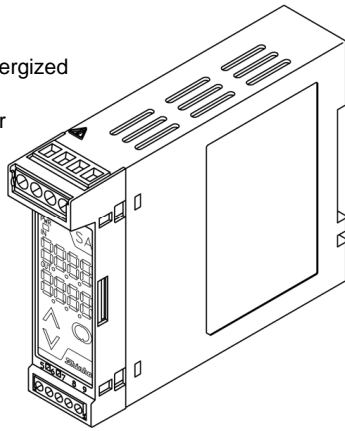

How to order

Specify a model. (e.g.) SAVA-0111-0

Model: SAVA - □ □ □ - □

Input

- 01: 0 to 100mV DC
- 02: 0 to 1V DC
- 03: 0 to 5V DC
- 04: 1 to 5V DC
- 05: 0 to 10V DC

Alarm 1 output (Relay contact 1a) *1

- 0: No alarm action
- 1: High limit alarm
- 2: Low limit alarm
- 3: High limit alarm with standby
- 4: Low limit alarm with standby

Alarm 2 output (Open collector) *1

- 0: No alarm action
- 1: High limit alarm
- 2: Low limit alarm
- 3: High limit alarm with standby
- 4: Low limit alarm with standby

Power supply

- 0: 100 to 240V AC
- 1: 24V AC/DC

*1: The alarm type can be selected by keypad from No alarm action, High limit alarm, Low limit alarm, High limit alarm with standby and Low limit alarm with standby.

Input specifications

DC voltage

Input range	Input resistance	Allowable signal source resistance
0 to 100mV DC	1MΩ	200Ω or less
0 to 1V DC		
0 to 5V DC	100kΩ	100Ω or less
1 to 5V DC		
0 to 10V DC		

Output specifications

For Alarm 1 and Alarm 2, the alarm type can be selected respectively from High limit alarm, Low limit alarm, High limit alarm with standby, Low limit alarm with standby and No alarm.

High limit alarm

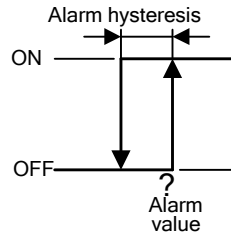

Low limit alarm

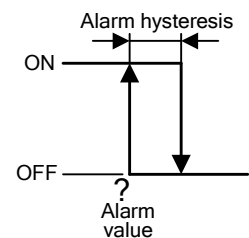

High limit alarm with standby

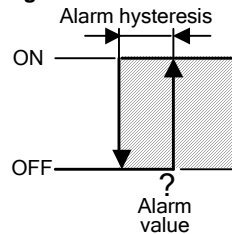

Low limit alarm with standby

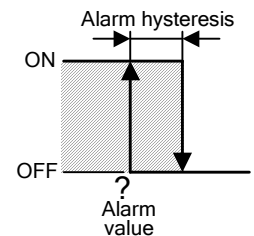

▨ Standby functions.

Alarm action: ON/OFF action, Alarm hysteresis: 0.1 to 100.0%FS, Delay timer: 0 to 9999sec, Energized/De-energized Alarm Holding/Not holding, Selectable

Alarm 1 output: Relay contact 1a, Control capacity: 3A 250V AC (Resistive load), 1A 250V AC (Inductive load cosφ=0.4) Electric life 100,000 cycles

Alarm 2 output: Open collector, Control capacity: 0.1A 24V DC

Performance

- Setting accuracy : The same as the Display accuracy
- Reference accuracy : Within ±0.2%
- Display accuracy : Within Reference accuracy ±1 digit
- Temperature coefficient: ±0.015%/°C
- Response time : 1 sec or less
- Insulation resistance : 10MΩ or more, at 500V DC (Input - Output - Power)
- Dielectric strength: 1500V AC for 1 minute (Input - Alarm 1 output - Alarm 2 output - Power)
- Isolation: 3-port isolation (between Input - Output - Power)

General structure

- Case: Flame-resistant resin Color: Light gray
- Front panel: Membrane sheet Setting: Using the front keypad
- Indication: Power indicator: Green LED
- Input display: 7-segment, Red LED display 4-digit Character size, 7.4 x 4.0mm (H x W)
- Set value display: 7-segment, Green LED display 4-digit Character size, 7.4 x 4.0mm (H x W)

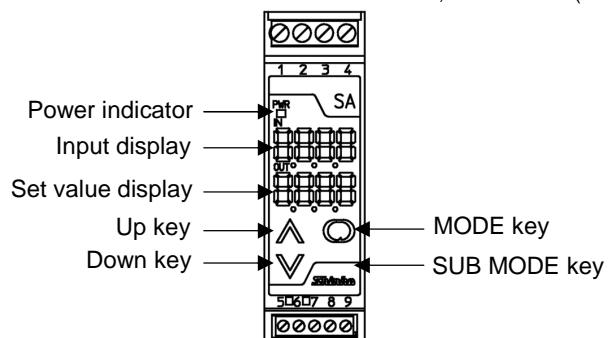

■ Installation specifications

- Power supply : 100 to 240V AC 50/60Hz
24V AC/DC 50/60Hz
- Allowable voltage range: 85 to 264V AC, 20 to 28V AC/DC
- Power consumption : Approx. 6VA
- Ambient temperature : -5 to 55°C
- Ambient humidity : 35 to 85%RH (non-condensing)
- Mounting : DIN rail mounting
- External dimensions : 22.5 (W) x 75 (H) x 100 (D)mm
- Weight : Approx. 120g

■ Attached functions

- Power failure countermeasure:
The data is backed up in non-volatile IC memory.
- Self diagnosis:
The CPU is monitored by a watchdog timer, and if an abnormal status is found on the CPU, the unit is switched to warm-up status with turning all outputs off.

■ Environmental specification

RoHS directive compliance

■ Settings

Function keys

- (1) Up key : Increases the numeric value.
- (2) Down key : Decreases the numeric value.
- (3) MODE key : Selects the setting mode.
- (4) SUB MODE key : Press with the MODE key to select the setting mode.

Setting items

- Setting by pressing the MODE key for 3 seconds
 - (1) Alarm 1 value (2) Alarm 2 value
- Setting by the MODE key and SUB MODE key
 - (1) Set value lock
 - (2) Decimal point place
 - (3) Scaling low limit value
 - (4) Scaling high limit value
 - (5) Filter time constant
 - (6) Sensor correction
 - (7) Alarm 1 type
 - (8) Alarm 2 type
 - (9) Alarm 1 Energized/De-energized
 - (10) Alarm 2 Energized/De-energized
 - (11) Alarm 1 Hold function
 - (12) Alarm 2 Hold function
 - (13) Alarm 1 hysteresis
 - (14) Alarm 2 hysteresis
 - (15) Alarm 1 action delay timer
 - (16) Alarm 2 action delay timer
 - (17) Display selection
 - (18) Indication time

■ Displays and indicators

- Power indicator : The green LED lights when the power to the instrument is turned on.
- Input display : Indicates the input value.
- Under range : "----" flashes on the Input display.
- Over range : "----" flashes on the Input display.
- Warm-up indication: For approx. 3sec after power-on, the input type is indicated on the Input display, and Scaling high limit value is indicated on the Set value display.
- Set value display: Indicates the one which has been selected during "Display selection" mode. Indicates Alarm 1 value or Alarm 2 value. Indicates characters shown below while alarm output is on.

Alarm output status	Set value display
Alarm 1 output ON	u 100
Alarm 2 output ON	u 000
Alarm 1, 2 outputs ON	u 100

■ Ferrules

Terminals from 1 to 4

- Insulation sleeve attached (Phoenix Contact GMBH & CO.)
 - A10.25-8YE 0.2 – 0.25mm²
 - A10.34-8TQ 0.25 – 0.34mm²
 - A10.5-8WH 0.34 – 0.5mm²
 - A10.75-8GY 0.5 – 0.75mm²
 - A11.0-8RD 0.75 – 1.0mm²
 - A11.5-8BK 1.0 – 1.5mm²
- Crimping pliers (Phoenix Contact GMBH & CO.)
CRIMPFOX ZA3, CRIMPFOX UD6

Terminals from 5 to 9

- Insulation sleeve attached (Phoenix Contact GMBH & CO.)
 - A10.25-8YE 0.2 – 0.25mm²
 - A10.34-8TQ 0.25 – 0.34mm²
 - A10.5-8WH 0.34 – 0.5mm²
- Crimping pliers (Phoenix Contact GMBH & CO.)
CRIMPFOX ZA3, CRIMPFOX UD6

■ Circuit configuration and terminal arrangement

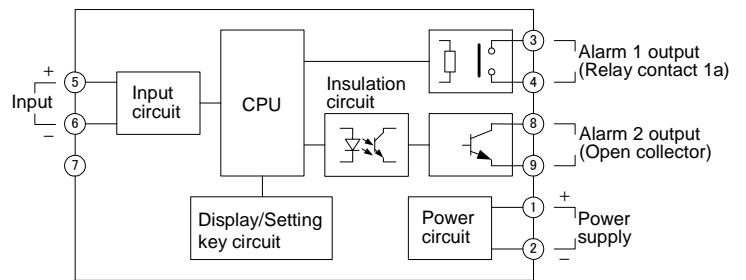

Alarm 1 output: Take measures for relay protection and noise prevention as shown below.

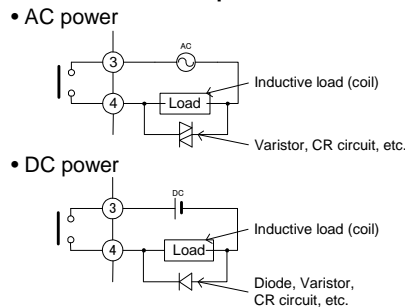

Alarm 2 open collector output connection example

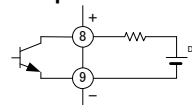

■ External dimensions (Scale: mm)

