

1ch Alarm Detector (Thermocouple) (with two large displays) Model: SE1EA

■ Features

- Alarm Energized/De-energized
- Alarm HOLD function
- Alarm delay function
- Set value lock

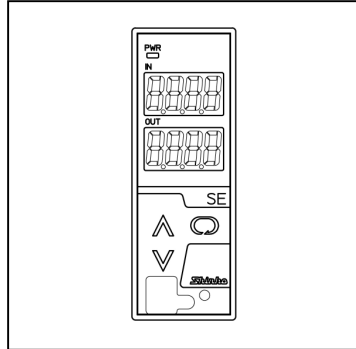

■ Model

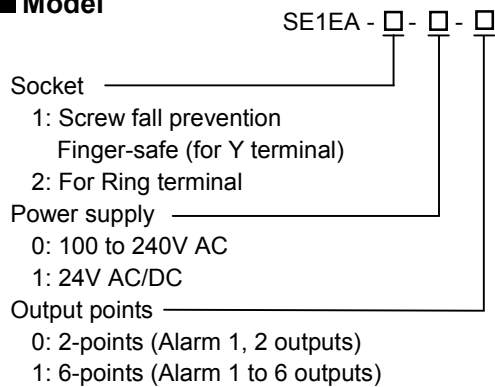

■ How to Order

Specify a model. (E.g.) SE1EA-1-0-0
 Factory adjusted value:

| | |
|-------|-------------------|
| Input | K: -200 to 1370°C |
|-------|-------------------|

■ Input Specifications

Thermocouple

Input resistance: 1MΩ or more
 External resistance: 100Ω or less, however B: 40Ω or less
 Burnout: Upscale
 Input:

| Thermocouple | Input range | |
|--------------|-----------------|-----------------|
| K | -200 to 1370 °C | -328 to 2498 °F |
| J | -200 to 1000 °C | -328 to 1832 °F |
| R | -50 to 1760 °C | -58 to 3200 °F |
| S | -50 to 1760 °C | -58 to 3200 °F |
| B | 0 to 1820 °C | 32 to 3308 °F |
| E | -200 to 800 °C | -328 to 1472 °F |
| T | -200 to 400 °C | -328 to 752 °F |
| N | -200 to 1300 °C | -328 to 2372 °F |
| PL-II | 0 to 1390 °C | 32 to 2534 °F |
| W5Re/W26Re | 0 to 2315 °C | 32 to 4199 °F |
| W3Re/W25Re | 0 to 2315 °C | 32 to 4199 °F |

Minimum span: 50°C (100°F)

■ Output Specifications

A maximum of 6 points of alarm output available. For each alarm output, one of the following types can be selected in [Alarm type]: High limit alarm, Low limit alarm, High limit alarm with standby and Low limit alarm with standby.

• High limit alarm

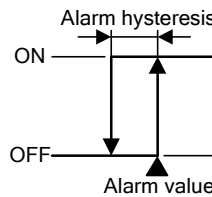

• Low limit alarm

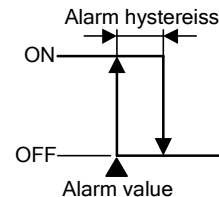

• High limit alarm with standby • Low limit alarm with standby

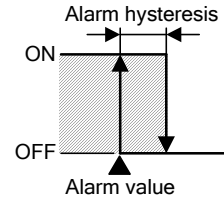
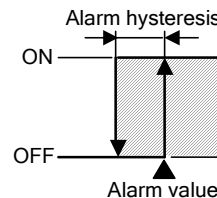

▨ Standby functions.

- Alarm action: ON/OFF action
- Alarm hysteresis: 0.1 to 100.0%FS
- Alarm delay time: 0 to 9999 sec
- Alarm Energized/De-energized, Selectable
- Alarm HOLD function Enabled/Disabled, Selectable
- Alarm 1, 2 outputs: Relay contact 1a
- Control capacity: 3A 250V AC (resistive load)
1A 250V AC (inductive load cosφ=0.4)
- Electric life: 100,000 cycles
- Alarm 3 to 6 outputs: Open collector
- Control capacity: 0.1A 24V DC

■ Performance

- Reference accuracy (Ambient temperature: 23°C)
- **Thermocouple input:** Within ±0.1% of each input span
- R, S inputs, -50 to 200°C (-58 to 392°F): Within ±6°C (12°F)
- B input, 0 to 300°C (32 to 572°F): Accuracy is not guaranteed.
- K, J, E, T, N inputs, Less than 0°C (32°F): Within ±0.4% of each input span
- Cold junction compensation accuracy: Within ±1°C at -5 to 55°C
- Indication accuracy: Within Reference input accuracy ±1 digit
- Input sampling period: 25msec, 125msec, 250msec (Selectable by keypad)
- Temperature coefficient: ±0.015%/°C or less
- Insulation resistance: 10MΩ or more, at 500V DC (Input - Output - Power)
- Dielectric strength: 1.5kV AC for 1 minute (Input - Output - Power)

■ General Structure

Case: Flame-resistant resin Color: Light gray
 Front panel: Membrane sheet

Setting: Using the front keypad
 Display: Input display: 7-segment Red LED display
 4-digit, Character size, 10x4.6mm (HxW)
 Set value display: 7-segment Red LED display
 4-digit, Character size, 10x4.6mm (HxW)
 Power indicator: Green LED

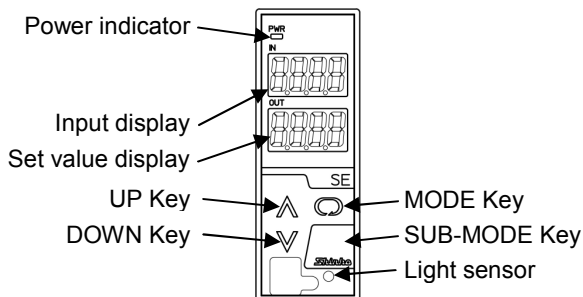

Installation Specifications

Power supply: 100 to 240V AC 50/60Hz
 24V AC/DC 50/60Hz
 Allowable voltage range: 85 to 264V AC, 20 to 28V AC/DC
 Power consumption: Approx. 9VA
 Ambient temperature: -5 to 55°C
 Ambient humidity: 35 to 85%RH (non-condensing)
 Mounting: DIN rail
 External dimensions: W30xH88xD108mm (socket included)
 Weight: Approx. 200g (socket included)

Attached Functions

Auto-light function: Automatically measures and controls brightness of the displays to conserve power.
 Power failure countermeasure:
 The data is backed up in non-volatile IC memory.
 Self diagnosis: The CPU is monitored by a watchdog timer, and when an abnormal status is found on the CPU, the unit is switched to warm-up status turning all outputs OFF.
 Cold junction temperature compensation: Available

Environmental Specification

RoHS directive compliance

Settings

Function keys

- (1) UP Key: Increases a numerical value.
- (2) DOWN Key: Decreases a numerical value.
- (3) MODE Key: Selects a setting mode.
- (4) SUB-MODE Key: Re-lights displays. (UP Key, DOWN Key or MODE Key also re-lights displays.)

Displays and Indicator

Input display: Indicates the input value.
 Indication of -200.0 or less (ranges with decimal point):
 The minus (-) sign and input value light alternately.
 Under range: -10% of input span or less:
 " _ _ _ _ " flashes on the Input display.
 Over range: 110% of input span or more:
 " _ _ _ _ " flashes on the Input display.
 Warm-up indication: The input type is indicated on the Input display for 3 seconds after power is turned ON.
 Set value display: Alarm 1 (A1) to Alarm 6 (A6) values are indicated (follows the selection in "Display selection").
 If the UP Key is pressed for 1 second during alarm value indication, alarm values will be switched thus.
 (A1 → A2 •••• A6 → A1).
 When power is turned ON, A1 value is indicated.

When alarm output is ON, "AL" and the value selected in [Display selection] are alternately indicated on the Set value display. If the UP Key is pressed together with the DOWN Key in the above status, the alarm output currently being turned ON will be displayed.
 (E.g.) If Alarm 1 and Alarm 3 outputs are ON, "A1" and "A3" are displayed in order.

Power indicator (green): Lit when power is turned ON.

Ferrules

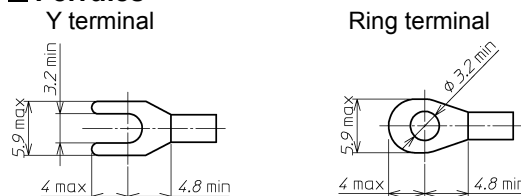

Circuit Configuration & Terminal Arrangement

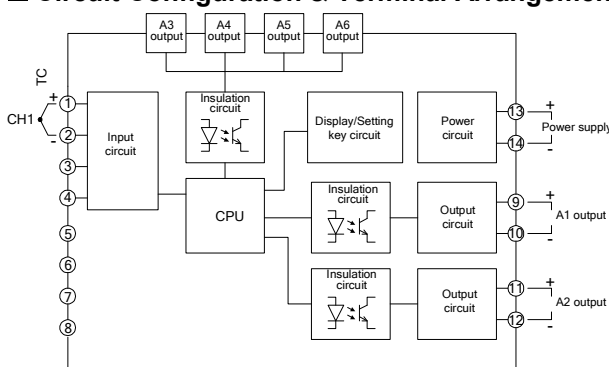

Alarm 1, 2 outputs: Take the following measures for relay contact protection and noise reduction.

AC power

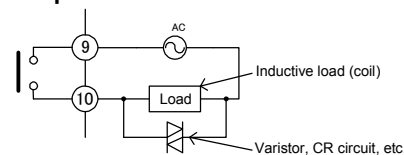

DC power

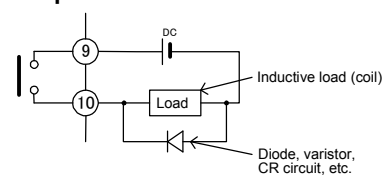

Alarm 3 to 6 outputs: Connection example of Open collector output

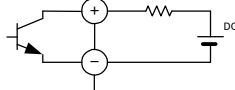

External Dimensions (Scale: mm)

